



**Owner's manual**  
**Tiguan, Tiguan R**  
Edition 11.2021



Tiguan, Tiguan R Owner's manual

Owner's manual  
Tiguan, Tiguan R  
V1, R1, en\_GB  
Print status: 23.07.2021  
English: 2021.11  
Teile-Nr.: 5NA012720AN



5NA012720AN

Individual vehicle details may be entered here:

Vehicle identification number															

Vehicle information
Engine power (kW)
Engine code
Gearbox code
Paint number
Recommended engine oil

PR No.	Service type of vehicle

Notes	
<p>Pre-delivery inspection carried out on:</p> <p style="text-align: center;">Volkswagen dealership stamp</p>	<p>Date of delivery / first registration (whichever comes first):</p> <p style="text-align: center;">Volkswagen dealership stamp</p>

Volkswagen AG works continuously to develop and further improve all vehicle types and models. Please understand that we must therefore reserve the right to alter any part of the vehicle and its equipment or technical specifications at any time. The data provided concerning scope of delivery, appearance, performance, dimensions, weights, standards and vehicle functions are all correct at the time of going to print. Some of the equipment and functions described might not yet be available or may be available only in certain countries. Information about this is available from your local Volkswagen dealership. The vehicle shown may have certain items of optional equipment which are only available at extra

cost, or which are only available in certain markets. Your Volkswagen dealership will be able to inform you about variations in different countries. Subject to alteration and amendment. No legal commitment may be inferred from the information, illustrations or descriptions in this manual. No part of this manual may be reprinted, reproduced or translated without the written permission of Volkswagen AG. All rights under the laws of copyright are expressly reserved by Volkswagen AG. Subject to alteration and amendment. © 2021 Volkswagen AG

## Thank you for choosing Volkswagen

By purchasing this Volkswagen, you have become the owner of a vehicle fitted with the most up-to-date technology and a multitude of convenience functions for your use and enjoyment.

**Before using your vehicle for the first time, please read and observe the information in this owner's manual. It will quickly help you to become familiar with your vehicle and all of its functions as well as making you aware of dangers to yourself and others and of how these dangers can be avoided.**

If you have any further questions about your vehicle, or if you think that the vehicle wallet has not covered everything, please get in touch with your Volkswagen dealership. They will always be happy to deal with your questions, suggestions or problems.

We hope you enjoy driving your new vehicle. Happy motoring.



### WARNING

Please observe the important safety instructions for use of child restraint systems on the front passenger seat → page 58



# Table of Contents

## Vehicle overviews

– Front view	8
– Rear view	9
– Driver door	10
– Driver side	12
– Centre console	14
– Front passenger side	15
– Controls in the roof	16

## Driver information

– Symbols in the instrument cluster	17
– Warning and information messages	20
– Introduction to instrument cluster	20
– Digital instrument cluster Pro version	21
– Analogue instrument cluster	26
– Rev counter	28
– Fuel gauge	28
– Coolant temperature display	29
– Head-up display (HUD)	30
– Driving data display (multifunction display)	31
– Service	32
– Time	34
– Sports displays	35
– Vehicle settings menu	37
– Driver Alert System	38
– Dynamic Road Sign Display	39
– Personalisation	41

## Safety

– Sitting position	43
– Seat belts	44
– Proactive occupant protection system	49
– Airbag system	50
– Safe transport of children	58
– In an emergency	65

## Opening and closing

– Vehicle key	71
– Keyless locking and starting system “Keyless Access”	72
– Doors and central locking button	74
– Anti-theft alarm	78
– Interior monitoring system and anti-tow alarm	79
– Boot lid	80
– Windows	85
– Glass roof	87

## Steering wheel

– Adjusting the steering wheel position	89
---	----

## Seats and head restraints

– Front seats	90
– Rear seats	94
– Head restraints	96
– Seat functions	98

## Lights

– Vehicle lighting	102
– Fog lights	107
– Side lights	107
– Light functions	109
– Interior lighting	110

## Vision

– Wipers	111
– Mirrors	114
– Protection from the sun	117
– Windscreen with windscreen heating	118

## Heating and air conditioning system

– Climatronic	119
– Manual air conditioning system	121
– Temperature control	121
– Air distribution and fan speed	122
– Defrost function	122
– Air recirculation mode	123
– Seat heating	123
– Steering wheel heating	124
– Windscreen heating	125
– Rear window heating	125
– Supplementary heating function	125
– Auxiliary heater and auxiliary ventilation	126
– Remote control for the auxiliary heater and auxiliary ventilation	127
– Troubleshooting	129

## Driving

– Notes on driving	131
– Starting and stopping the engine	138
– Start/stop system	144
– Manual gearbox	146
– Automatic gearbox	147
– Driving on uphill gradients	152
– Steering	154
– Driving profile selection and 4MOTION Active Control	155
– Offroad display	159
– Offroad driving	160

## Driver assist systems

– Cruise control system	168
– Speed limiter	170

– Adaptive Cruise Control (ACC)	171	– Roof carrier	281
– Predictive cruise control system	177		
– Area monitoring system (Front Assist)	179	<b>Fuel and emission control</b>	
– Lane keeping system (Lane Assist)	182	– Safety information on using fuel	283
– Travel Assist	184	– Fuel types and refuelling	283
– Semi-automated vehicle assistance in a medical emergency (Emergency Assist)	187	– Emission control	286
– Lane change system (Side Assist)	188		
		<b>If and when</b>	
<b>Parking and manoeuvring</b>		– Vehicle toolkit	292
– Parking	190	– Wiper blades	292
– Electronic parking brake	191	– Exterior lighting	294
– Information about the parking systems	193	– Changing fuses	297
– Park Distance Control	197	– Jump starting	302
– Rear view camera system	199	– Towing	305
– Park Assist	201		
– Area View	204	<b>Checking and refilling</b>	
– Trailer manoeuvring system (Trailer Assist)	205	– In the engine compartment	310
– Rear Traffic Alert	207	– Service fluids and consumables	313
– Brake support systems	207	– Washer fluid	313
		– Engine oil	314
<b>Practical equipment</b>		– Coolant	318
– Stowage areas	210	– Brake fluid	321
– Ashtray and cigarette lighter	211	– 12-volt vehicle battery	322
– Sockets	212		
		<b>Wheels and tyres</b>	
<b>Data transfer</b>		– Tyre monitoring systems	326
– Cybersecurity	214	– Useful information about wheels and tyres	331
– System update	214	– Hubcaps	341
– We Connect	217	– Changing a wheel	343
– Privacy settings	221	– Breakdown set	349
– User administration	222		
– We Upgrade	223	<b>Maintenance</b>	
– Wi-Fi hotspot	224	– Service	353
– App-Connect	227	– Vehicle care	355
– Cable and wireless connections	231	– Accessories, modifications, repairs and renewal of parts	361
<b>Infotainment system</b>		<b>Customer information</b>	
– Getting started	234	– Warranty	365
– Radio mode	245	– LongLife mobility guarantee	366
– Media mode	248	– Data storage and services	366
– Navigation	251	– Event data recorder	368
– Mobile phone interface	257	– Information stickers and plates	369
– Voice control	262	– Fluids in the air conditioning system	369
		– Infotainment system and antennas	370
<b>Transporting items</b>		– Component protection	370
– Stowing luggage and loads	266	– Information in accordance with the EU Chemicals Regulation REACH	370
– Luggage compartment cover	267	– Disposal of used batteries and electronic devices	370
– Luggage compartment floor	267	– Declaration of conformity for components not related to radio equipment	371
– Net partition	268	– Third party copyright law information	371
– Luggage compartment equipment	270	– Returning and scrapping end-of-life vehicles	371
– Towing a trailer	273		
– Towing bracket	277		
– Bicycle carrier	280		

– Information about vehicles with N1 approval (light commercial vehicle)	372
---	-----

---

#### Information on radio equipment regulations

– Declaration of Conformity for radio systems in the European Union (EU)	373
– Declaration of Conformity for radio systems in countries outside the European Union (EU)	378

---

#### Technical data

– Notes on technical data	388
– Vehicle identification number	388
– Type plate	390
– Safety certificate	390
– Dimensions	391
– Tank capacities	392
– Petrol engines	392
– Diesel engines	399

---

<b>Abbreviations used</b>	405
---------------------------	-----

<b>Index</b>	407
--------------	-----

## About this owner's manual

This owner's manual is valid for all variants and versions of your Volkswagen model and model year. The owner's manual describes all equipment and models without indicating whether the equipment is optional or specific to the model type. This means that your vehicle may not have some of the equipment described, or it may only be available in certain countries. For information on your actual vehicle equipment, please refer to the sales documents or contact a correspondingly qualified workshop. Volkswagen recommends using a Volkswagen dealership.

A passenger car is described in this owner's manual.

Depending on the market-dependent vehicle approval, the model version may also be a light commercial vehicle.

All data in this owner's manual correspond to the information available at the time of going to print. Because the vehicle is constantly being developed and further improved, there may be differences between your vehicle and the data in this owner's manual. No discrepancy in data, illustrations or descriptions shall form the basis for any legal claim.

An alphabetical [index](#) and a [list of abbreviations](#) that explains technical abbreviations and terms help you to find your way around and understand the printed owner's manual.

**Short definitions** in a contrasting colour that precede some sections provide a summary of the respective topic. More detailed information about the features, conditions and limitations of systems and equipment can be found in the relevant sections.

### **Booklets in the vehicle wallet:**

Due to legal and technical requirements, the vehicle may be equipped with different variants of an owner's manual depending on country.

The printed owner's manual describes the functions of the vehicle at the time of going to print. Additions and changes to the owner's manual may also be enclosed as a supplement.

 If you sell or lend the vehicle to someone else, make sure that the printed documents are always in the vehicle. Volkswagen also recommends restoring the Infotainment system to the factory settings in order to delete all personal data. <

# Explanations

Formulations and terminology used in the owner's manual are explained below to permit easier understanding.

### Directions and positions

Directions and positions such as left, right, front and rear are normally relative to the vehicle's direction of travel, unless otherwise indicated.

### Dimensions and speeds

Values given in miles instead of kilometres or mph instead km/h refer to the country-specific instrument clusters or Infotainment systems.

### Illustrations

Illustrations help with orientation and should be regarded as a general guide. The illustrations may differ from your vehicle.

This owner's manual was written for left-hand drive vehicles. In *right-hand drive vehicles* the controls may sometimes differ from those displayed in illustrations or described in the text.

### Form of address

For better legibility, the male form of address is used. However, this refers to all genders equally. The shortened linguistic form is used for editorial reasons and does not represent a value judgement.

### Terms used and their meaning:

**Glass roof** The term glass roof is used as a standard term for all equipment-dependent versions of the sliding and tilting roof.

**Qualified workshop** Qualified workshops are workshops that employ instructed or trained personnel and that specialise in performing service work on passenger cars. A qualified workshop can be both a Volkswagen dealership and also an independent workshop.

**Volkswagen dealership** Volkswagen dealerships are workshops that have a contractual relationship with Volkswagen. The contractual relationship means that additional information is available, and there is also a direct communication channel to the manufacturer.

**Go to a qualified workshop** In some situations, it is necessary for you to drive your vehicle to a qualified workshop to have it checked.

**Seek expert assistance** If it should not be possible to continue driving the vehicle at any time, it is necessary to have the vehicle checked by an expert on the spot. A decision on whether it is possible to continue driving or whether the vehicle has to be towed must be taken after this depending on the situation. <



## Description of symbols



Refers to a section within a chapter that contains important information and safety notes  that should always be observed.



Indicates the end of a section.



Indicates situations in which the vehicle must be stopped as quickly as possible.

TM

The symbol means "Trademark" and identifies an recognised but not (yet) officially registered mark. However, the absence of this symbol does not constitute a waiver of the rights concerning any term.



The symbol indicates a registered mark. However, the absence of this symbol does not constitute a waiver of the rights concerning any term.



Symbols like these refer you to warnings within the same section or on a given page. They draw your attention to possible risks of accident or injury and explain how they can be avoided.



Cross reference to potential risks of damage to property in the same section or on the page specified.



### DANGER

Texts with this symbol indicate dangerous situations which will lead to fatal or severe injuries if you do not observe the warning.



### WARNING

Texts with this symbol indicate dangerous situations which could lead to fatal or severe injuries if you do not observe the warning.



### CAUTION

Texts with this symbol indicate dangerous situations which could lead to slight or medium injuries if you do not observe the warning.



### NOTICE

Texts with this symbol indicate situations which could cause vehicle damage if you do not observe the warning.



Texts with this symbol contain additional information on the protection of the environment.



Texts with this symbol contain additional information.



# Vehicle overviews

## Front view

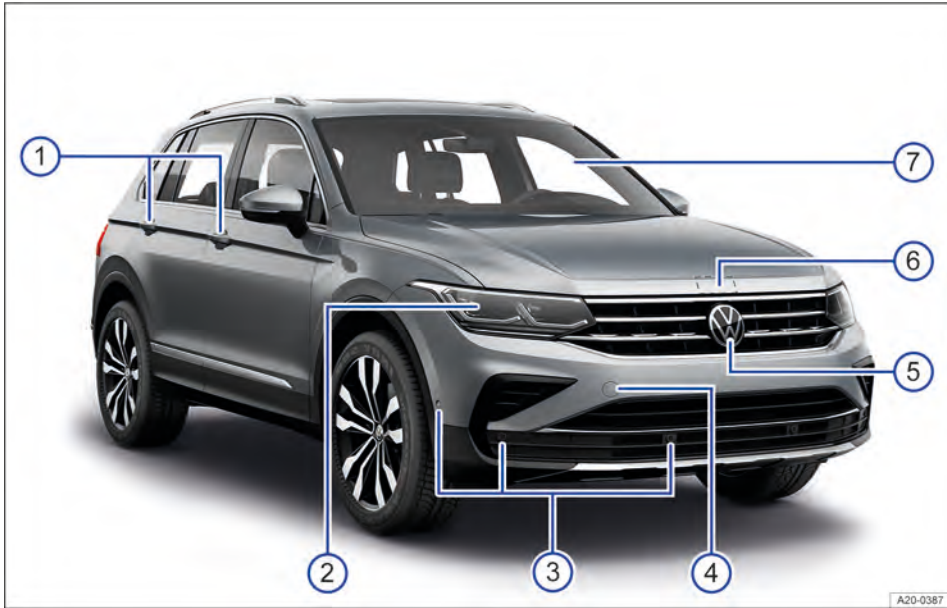

Fig. 1 Overview of the front of the vehicle.

① Door handles .....	74
② Headlights .....	294
③ Sensors for assist systems .....	357
④ Behind a cover: mounting for towing eye .....	305
⑤ Behind the Volkswagen badge: radar sensor for assist systems .....	357
⑥ Opening lever for bonnet .....	312
⑦ Windscreen:	
– with vehicle identification number .....	388
– with windscreen heating .....	125
– with windscreen wiper .....	111
– with camera window for assist systems .....	357
– with rain/light sensor positioned near the interior mirror .....	113, 357

## Rear view

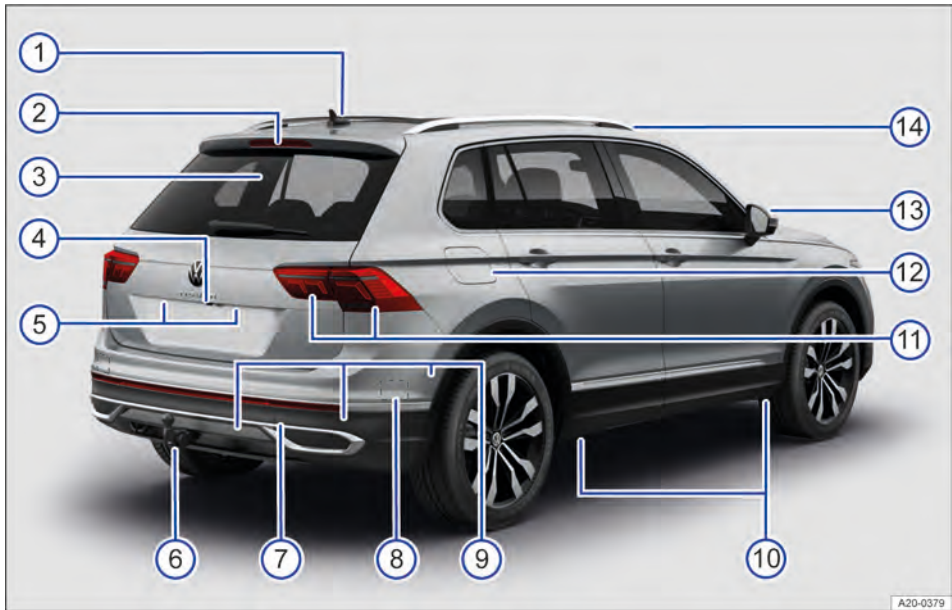

Fig. 2 Overview of vehicle from rear.

①	Roof aerial .....	370
②	High-level brake light .....	
③	Rear window:	
	– with rear window heating .....	125
	– with rear window wiper .....	111
④	Area:	
	– of the button for opening the boot lid .....	80
	– of the camera for parking systems .....	199, 357
⑤	Number plate light .....	294
⑥	Towing bracket .....	273
⑦	Behind a cover: mounting for towing eye .....	305
⑧	Behind the bumper: radar sensor for assist systems .....	357
⑨	Sensors for assist systems .....	357
⑩	Jacking points .....	343
⑪	Tail light clusters .....	294
⑫	Tank flap .....	283
⑬	Exterior mirrors .....	115
	– With display of lane change system (Side Assist) .....	188
	– With camera for Area View .....	204, 357
⑭	Roof railing .....	281

## Driver door

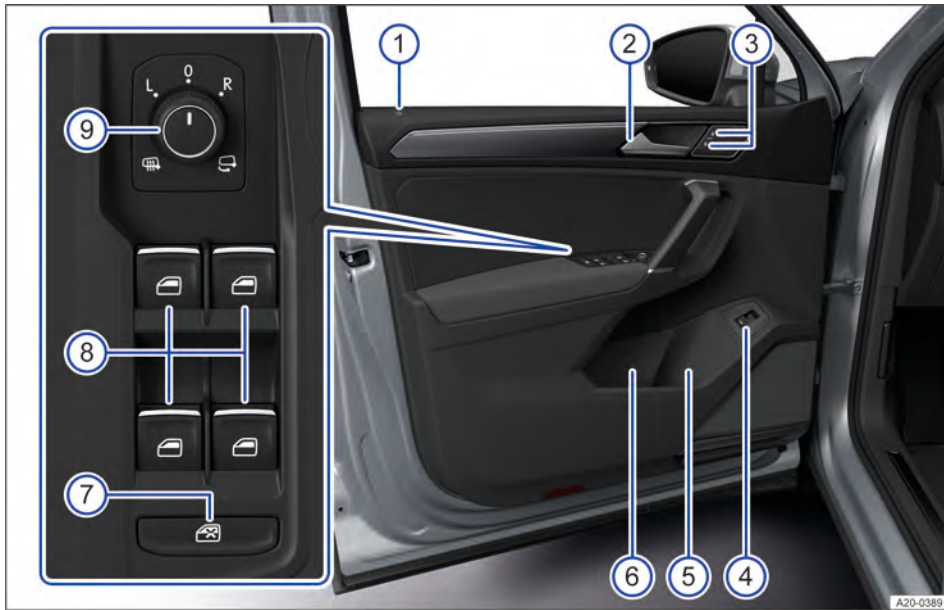

Fig. 3 Driver door (left-hand drive vehicles): controls (mirrored for right-hand drive vehicles).

① Central locking system indicator lamp .....	74
② Door release lever .....	
③ Central locking button for locking and unlocking the vehicle .....	75
④ Button for opening the boot lid .....	80
⑤ Stowage compartment with bottle holder .....	
⑥ Stowage compartment for high-visibility waistcoat .....	66
⑦ Button for deactivating the electric window buttons in the rear doors. ....	85
⑧ Buttons for operating the electric windows .....	85
⑨ Rotary knob for exterior mirror settings and functions .....	115
– With control function for trailer manoeuvring system (Trailer Assist) .....	205 ◀

5NA012720AN

Driver door | 11

## Driver side

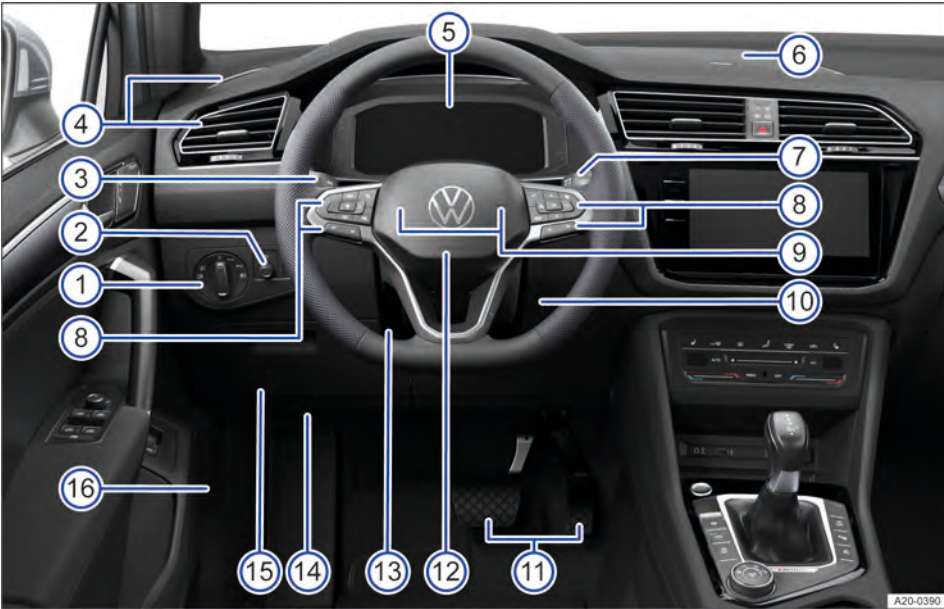

Fig. 4 Overview of the driver side (left-hand drive vehicles).

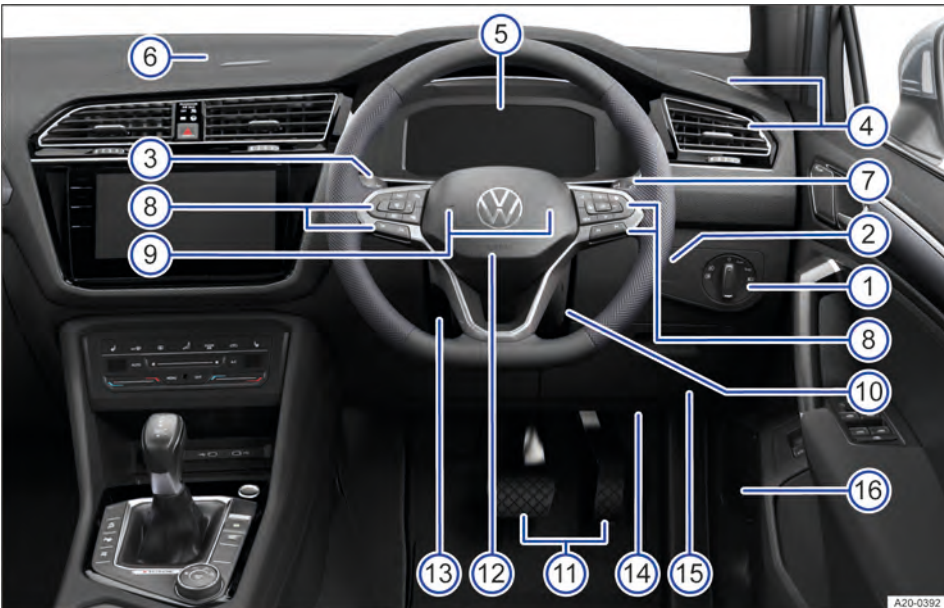







Fig. 5 Overview of the driver side (right-hand drive vehicles).

①	Light switch .....	102
②	Control for headlight range control and for the head-up display .....	109, 30
③	Turn signal and main beam lever .....	102, 104
	– With switches and buttons for the driver assist systems .....	168
④	Vents .....	122
⑤	Instrument cluster .....	21
	– with warning and indicator lamps .....	17
⑥	Stowage compartment	
⑦	Lever for wipers and washers .....	111
	– With buttons for operating the menus .....	22
⑧	Controls on the multifunction steering wheel:	
	– for driver assist systems .....	168
	– for menu selection .....	22
	– for accepting telephone calls <b>OK</b>	
	– for audio, navigation  ,  , .....	234, 251
	– for volume adjustment  	
	– for activating voice control  (function may not be available depending on vehicle equip- ment) .....	262
	– to switch between the current and previous menus <b>VIEW</b> .....	22
⑨	Horn	
⑩	Ignition lock .....	138
⑪	Pedals .....	131
⑫	Location of the driver front airbag .....	50
⑬	Lever for adjusting the steering column position .....	89
⑭	Location of the knee airbag .....	50
⑮	Stowage compartment	
⑯	Bonnet release lever .....	312 ◀

## Centre console

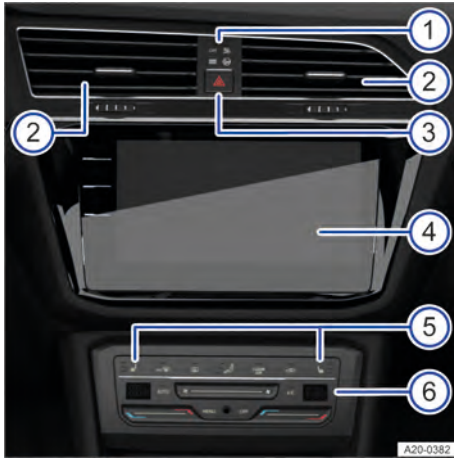

Fig. 6 Overview of the upper section of the centre console.

① Indicator lamp for the front passenger front airbag switch-off function <b>OFF</b>	50
② Vents .....	122
③ Hazard warning lights button	65
④ Infotainment system .....	234
⑤ Buttons for seat heating .....	123
⑥ Controls for air conditioning system .....	119
– with auxiliary heater .....	126

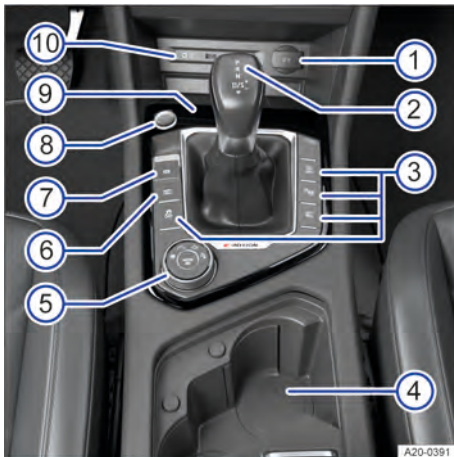

Fig. 7 Overview of the lower section of the centre console (left-hand drive vehicles).

① Cigarette lighter or 12-volt socket .....	212
---	-----



② Lever:	
– for DSG® dual clutch gearbox .....	147
– for manual gearbox .....	146
③ Buttons:	
– for start/stop system .....	144
– for assist systems for parking and manoeuvring .....	190
– for driving profile selection .....	155
④ Under a cover: drink holders	
⑤ Control for driving profile selection .....	155
⑥ Button for Auto Hold function .....	192
⑦ Electronic parking brake .....	191
⑧ Button for starting and switching off the engine (Press & Drive) .....	138
⑨ Stowage compartment	
– with function for wireless charging in accordance with Qi standard .....	260
⑩ USB sockets .....	231 <

## Front passenger side

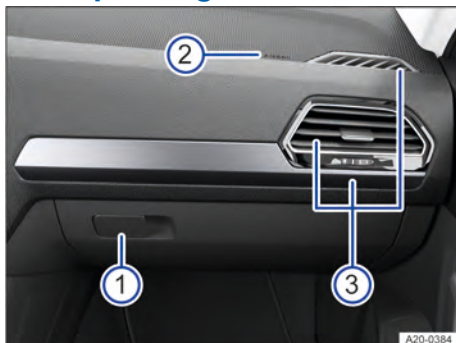





**Fig. 8** Front passenger side (left-hand drive vehicles): overview of dash panel (mirrored for right-hand drive vehicles).



**Fig. 9** With open front passenger door (left-hand drive vehicles): key-operated switch in the dash panel (mirrored for right-hand drive vehicles).

① Glove box:	
– with opening lever	
– with vent for cooling the glove box	
– with vehicle wallet	
② Location of front passenger front airbag in the dash panel .....	50
③ Vents .....	122
④ Key switch for switching off the front passenger front airbag .....	50 <

## Controls in the roof

Symbol	Meaning
	Buttons for interior and reading lights → page 110.
	Switch for glass roof → page 87.
	Buttons for the sun blind → page 117.
	Buttons for emergency call service, information call and break-down call → page 67. <span style="float: right;">◀</span>

# Driver information

## Symbols in the instrument cluster













The warning and indicator lamps can light up individually or in combination and indicate warnings, faults or certain functions. Some warning and indicator lamps light up when the ignition is switched on and should go out after a while.

























For details on indicator lamps that light up in the light switch, see Chapter "Lights" → page 103.

























### WARNING























Failure to observe illuminated warning lamps and text messages can lead to your vehicle breaking down in traffic and can cause accidents and serious injury.























- Never ignore any illuminated warning lamps or text messages.
- Stop the vehicle as soon as possible and when safe to do so.





















Symbol	Meaning
	 Do not drive on! Central warning lamp → page 20, → page 30
	Fasten seat belt → page 45
	Electronic parking brake → page 191
	 Do not drive on! Brake system fault → page 138
	 Do not drive on! Low brake fluid level → page 321
	Take over control of the vehicle and be prepared to brake. → page 172
	Engine oil level too low → page 318
	 Do not drive on! Engine oil pressure too low → page 317

Symbol	Meaning
	 Do not drive on! Fault in engine coolant system → page 30, → page 320
	 Do not drive on! Fault in steering → page 155
	Rear Traffic Alert has detected an obstacle at the rear → page 207
	 Do not drive on! Fault in the 12-volt power supply system → page 326
	Collision warning → page 180
	Take over steering immediately → page 186
	Selective catalytic reduction system fault → page 289
	AdBlue® level too low → page 290
	Central warning lamp → page 20
	Fault in airbag or belt tensioner system → page 52
	Airbag or belt tensioner system switched off with diagnostic tool → page 52
	OFF  Front passenger front airbag switched off → page 53
	ON  Front passenger front airbag switched on → page 53
	Emergency Call Service restricted → page 70
	SOS Emergency Call Service fault → page 70
	Electronic parking brake fault → page 192
	Check the brake pads → page 138
	Flashes: Electronic Stability Control (ESC) or traction control system (TCS) regulating → page 208, → page 208
	Lit up: Electronic Stability Control (ESC) fault → page 210

Symbol	Meaning
	Traction control system (TCS) switched off → page 209
	ESC Sport switched on → page 209
	Electronic Stability Control (ESC) switched off for system reasons → page 209
	Anti-lock brake system (ABS) fault → page 209
	Engine oil level too low → page 318
	Engine oil level too high → page 318
	Engine oil system fault → page 318
	Fuel tank almost empty → page 28
	Travel Assist not available → page 186
	Water in the diesel fuel → page 29
	Vehicle lighting failure → page 106
	Rear fog light switched on → page 107
	Rain/light sensor fault → page 107, → page 113
	Fault in wipers → page 113
	Washer fluid level too low → page 113
	Fault in steering → page 155
	 Do not drive on!
	Low tyre pressure → page 330, → page 330
	 Do not drive on!
	Fault in tyre monitoring system → page 330, → page 331
	Switching off Front Assist → page 181
	Front Assist is starting up → page 181
	Cruise control system fault → page 169

Symbol	Meaning
	Speed warning → page 32
	Adaptive Cruise Control (ACC) not available → page 176
	Lane keeping system (Lane Assist) is regulating → page 183
	Emergency Assist intervention → page 187
	Lane keeping system (Lane Assist) is regulating → page 183
	Emergency Assist intervention → page 187
	Fault in the lane change system (Side Assist) → page 189
	Rear Traffic Alert braking intervention → page 207
<b>EPC</b>	Fault in engine management system → page 142
	Exhaust system fault → page 291
	Diesel engine is getting pre-heated → page 138, → page 143
	Particulate filter clogged with soot → page 291
	Engine speed limited → page 143
	Fault in 12-volt vehicle battery → page 326
	Gearbox fault → page 147, → page 151
	Adaptive chassis control fault → page 158
	All-wheel drive → page 158
	Ball coupling of the towing bracket not locked → page 279
	Selective catalytic reduction system fault → page 289
	AdBlue level low → page 290
	Depress the brake pedal. → page 151, → page 151
	The vehicle is held stationary → page 193
	Turn signals → page 106

Symbol	Meaning
	Trailer turn signal → page 106
	Speed stored, regulation active → page 168, → page 175 The speed limiter is switched on → page 170
	Cruise control system switched on, control active. → page 168
	Speed limiter switched on, system control active. → page 170
	Lane Assist active → page 183
	Lane Assist active → page 183
	Travel Assist active → page 185
	The ACC is regulating, no vehicle detected in front → page 175
	The ACC is regulating, vehicle in front detected → page 175
	Hill Descent Control is active → page 153
	Main beam or headlight flasher → page 104
	Hill Descent Control is not active → page 153
	Outside temperature colder than +4°C (+39°F) → page 24
	Start/stop system active → page 144
	Start/stop system not available → page 144
	Economical mode → page 25
	Service due → page 33
	Travel Assist active, Adaptive Cruise Control active, adaptive lane guidance passive → page 185
	Main-beam control active → page 104, → page 105
	Take over steering → page 186
	Front Assist is starting up → page 181
	Distance warning → page 180

Symbol	Meaning
	Speed regulation is switched on → page 168
	Fault in the cruise control system → page 169
	The ACC is regulating, no vehicle detected in front → page 175
	The ACC is regulating, vehicle in front detected → page 175
	Speed limiter switched on, system control active → page 170
	Offroad driving profile → page 157
	Eco driving profile → page 157
	Comfort mode → page 157
	Speed regulation due to the road layout → page 178
	Normal driving profile → page 157
	Individual mode → page 157
	Sport mode → page 157
	Snow mode → page 157
	Offroad Individual driving profile. → page 157
	Mobile phone connected via Bluetooth® → page 25
	Race driving profile → page 157
	Mobile phone battery charge level → page 25
	Reference to information in the owner's manual → page 20
	Cruise control due to speed limit → page 178
	Selective catalytic reduction system fault → page 289
	AdBlue level low → page 289

## Warning and information messages

The system runs a check on certain components and functions in the vehicle when the ignition is switched on or while the vehicle is in motion. Malfunctions are indicated by red and yellow warning symbols with information messages on the instrument cluster display. An acoustic warning is also given in certain cases. The appearance of the text messages and symbols can vary depending on the version of the instrument cluster.

In addition, a list of current malfunctions can be opened manually. To do so, choose **Vehicle status** or **Vehicle** in the menu → page 37.

### **Priority 1 warning**

The red central warning lamp flashes or lights up, in some cases together with acoustic warnings or additional symbols.  **Do not drive on!** Danger. Check the fault. Seek expert assistance as soon as possible.

### **Priority 2 warning**

The yellow central warning lamp flashes or lights up, in some cases together with acoustic warnings or additional symbols. Malfunctions and insufficient service fluids can damage the vehicle and cause it to break down. Check the fault as soon as possible. In this case, go to a correspondingly qualified workshop immediately and have the system checked. Volkswagen recommends using a Volkswagen dealership.

### **Note about information in the owner's manual**

You will find further information on the warning in the owner's manual.

### **Information message**

Information about various procedures within the vehicle.

 If several warnings are present, the symbols will appear for several seconds, one after another. The symbols will continue to appear until the faults are rectified.

 If warnings about malfunctions are displayed when the ignition is switched on, it may not be possible to adjust some settings as described, or

the information display may appear differently. If the fault persists, go to a correspondingly qualified workshop. Volkswagen recommends using a Volkswagen dealership. 

## Introduction to instrument cluster

The vehicle may be equipped with an analogue or digital instrument cluster. The instrument cluster displays basic information such as speed.

The following functions are additionally available, among others, depending on the vehicle equipment:

- Various menus, e.g. for driver assist systems.
- Status displays for driver assist systems.
- Display messages.
- Warning and indicator lamps.
- Information on consumption and range.

The content can be individually customised and settings adjusted in the menus.

### **WARNING**



If the driver is distracted when driving, this can cause accidents and serious injuries.

- Never operate the instrument cluster while the vehicle is in motion.
- Adjust all settings in the instrument cluster and Infotainment system only when the vehicle is stationary.

### **WARNING**

The display may be switched off if there is a serious fault in the instrument cluster. The  indicator lamp may additionally light up.

- Stop the vehicle in a safe place.
- Seek expert assistance.

 When you start the engine after the 12-volt vehicle battery has been totally discharged, replaced or after a jump start, you may find that system settings, such as personal convenience settings and programming, have been changed or deleted. Check and correct the settings as necessary once the 12-volt vehicle battery has been sufficiently charged. 

## Digital instrument cluster Pro version

### Overview of the digital instrument cluster Pro version

The Digital Cockpit Pro is a digital instrument cluster with high-resolution TFT colour display. By selecting different information profiles, it is possible to view additional displays in addition to the standard round

instruments, e.g. rev counter. The term "digital instrument cluster Pro version" is used below to refer to the Digital Cockpit Pro.

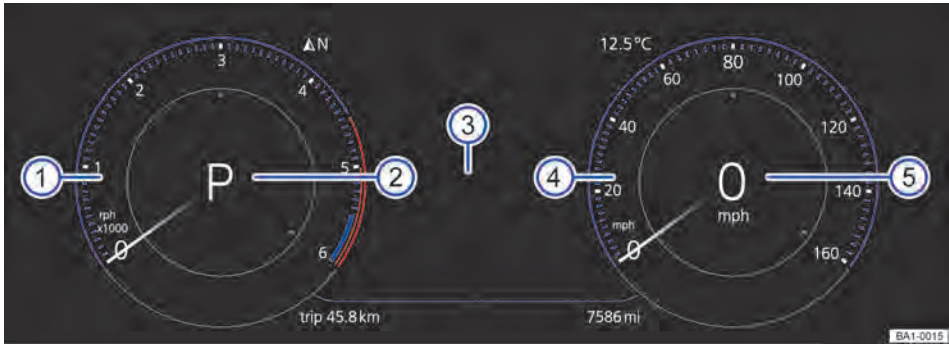

**Fig. 10** Digital instrument cluster Pro version in the dash panel (illustration).

- ① Rev counter (running engine speed in revolutions x 1,000 per minute).
- ② Currently selected gear or selector lever position → page 131.
- ③ Displays.
- ④ Speedometer.
- ⑤ Digital speed display.

## Operating the digital instrument cluster Pro version



**Fig. 11** Right-hand side of the multifunction steering wheel: controls for using the menus and information displays in the digital instrument cluster Pro version (variant 1).



**Fig. 12** Right-hand side of the multifunction steering wheel: controls for using the menus and information displays in the digital instrument cluster Pro version (variant 2).



**Fig. 13** On the right of the steering column: buttons on the wiper lever.

There are no buttons on the wiper lever in vehicles equipped with a multifunction steering wheel. The digital instrument cluster Pro version is then operated solely with the buttons on the multifunction steering wheel. The functions of the buttons on the multifunction steering wheel depend on the vehicle equipment.

*Vehicles with multifunction steering wheel:* If any priority 1 warnings are displayed, you will be unable to open any menus → page 20. You can confirm and hide some warnings using the **OK** button on the multifunction steering wheel → Fig. 11, → Fig. 12. *Vehicles without multifunction steering wheel:* If any priority 1 warnings are displayed, you will be unable to open any menus → page 20. Some warnings can be confirmed and hidden with the **OK/RESET** button → Fig. 13 ①.

### Selecting a menu or information display

*Vehicles with multifunction steering wheel:*

1. Switch on the ignition.
2. If a message or the vehicle pictogram is displayed, press the **OK** button, several times if required.
3. Press the **↵** or **↩** button to display a menu or browse through a menu.
4. To open the menu or information display shown, press **OK** or wait until the menu or information display opens automatically after a few seconds.

*Vehicles without multifunction steering wheel:*

1. Switch on the ignition.
2. If a message or the vehicle pictogram is displayed, press the button **OK/RESET** → Fig. 13 ①, several times if required.
3. To display the menus or to return from a menu or an information display to the menu selection, hold down the rocker switch → Fig. 13 ②.
4. To browse through the menus, press the rocker switch up or down.
5. To open the displayed menu or information display, press the button **OK/RESET** → Fig. 13 ① or wait until the menu or information display opens automatically after a few seconds.

### Changing settings in menus

*Vehicles with multifunction steering wheel:*

1. Press the arrow button **▲** or **▼** in the displayed menu until the required menu option is marked. A frame appears around the selected option.
2. Press the **OK** button to make the required changes.



A tick  indicates that the relevant function is switched on.

3. To return to menu selection, press the  or  button.

*Vehicles without multifunction steering wheel:*

1. In the menu displayed, press the rocker switch → Fig. 13  on the wiper lever upwards or downwards until the desired menu option is marked.

A frame appears around the selected option.

2. Press the button  → Fig. 13  to make the desired changes.

A tick  indicates that the relevant function is switched on.

3. Select the menu option **Back** or hold down the rocker switch → Fig. 13 .

### VIEW button on the multifunction steering wheel

*Vehicles with multifunction steering wheel:* The button  allows you to change between the classic view of the round instruments, the large view without information profiles and the extended view with highlighted information profiles. The classic view shows the large round instruments on the right and left and the selected information profile in the middle.

1. To select a profile from the list of default information profiles, press and hold the  button:

**Classic** View without information profile.

**Automatic** The information profiles adapt to the selected driving profile. Only for vehicles with driving profile selection.

**Memory entry 1** Individual selection of the information profiles.

**Memory entry 2** Individual selection of the information profiles.



**Memory entry 3** Only for vehicles with navigation system fitted at the factory.

### Navigation map on the digital instrument cluster Pro version

*Vehicles with multifunction steering wheel:* Depending on the vehicle equipment, the digital instrument cluster Pro version is able to display a detailed navigation map.

The navigation map can be shown in three sizes. With the larger map size, the navigation map is displayed over the entire width of the display. To select the preferred map size:

1. Select the **Navigation** menu option.
2. Press the  button on the multifunction steering wheel to toggle between map sizes.

3. Press the arrow button  or  on the multifunction steering wheel to zoom in and out.
4. To switch to Auto zoom, press the  button on the multifunction steering wheel when zooming manually.

Depending on the equipment level, navigation is shown on two screens or only one. The navigation map can be displayed in the digital instrument cluster Pro version and Infotainment system or only on the Infotainment system display. In the latter case, only navigation arrows are displayed in the digital instrument cluster.

 If warnings about malfunctions are displayed when the ignition is switched on, it may not be possible to adjust some settings as described, or the information display may appear differently. If the fault persists, go to a correspondingly qualified workshop. Volkswagen recommends using a Volkswagen dealership.

### WARNING

If the driver is distracted when driving, this can cause accidents and serious injuries.

- Never operate the digital instrument cluster Pro version while the vehicle is in motion.
- Adjust all settings in the digital instrument cluster Pro version and Infotainment system only when the vehicle is stationary.

## Information displays in the digital instrument cluster Pro version

### Information profiles

Various topic-specific information profiles → page 37 can be selected via the **Digital Cockpit** menu option in the vehicle settings of the Infotainment system. Depending on the selected information profile, the digital instrument cluster Pro version shows additional information in the centre of the round instruments, or the round instruments are hidden and the additional information is displayed across the whole width of the display. The following information profiles are available:

- Selector lever display. Digital display of the current gear or selected position.
- Speed. Digital display of the speed.
- Consumption. Graphic representation of current consumption and digital display of average consumption.
- Range. Digital display of the remaining range.

- Dynamic Road Sign Display. Display of recognised road signs.
- Distance covered. Digital display of the distance covered.
- Time of arrival information. Digital display of the remaining driving time, distance to the destination and estimated time of arrival.
- Acceleration. Graphic representation of longitudinal and lateral acceleration.
- Assist systems. Graphic representation of various driver assist systems → page 168.
- Height. Digital display of the current height above sea level.
- Navigation. Graphic representation of arrow navigation.
- Compass. Digital compass display.
- Audio. Digital display of current audio playback.

The number and scope of the available information profiles may differ depending on the vehicle equipment.

#### **Possible displays in the digital instrument cluster Pro version**

Depending on equipment, a range of information can be displayed in the digital instrument cluster Pro version:

- Open doors, bonnet and boot lid.
- Mileage displays.
- Telephone information.
- Outside temperature display.
- Compass display.
- Selector lever position.
- Gear-change indicator → page 131.
- Speed warning for winter tyres.
- Depending on equipment: economical mode . Status display for Active Cylinder Management (ACT) → page 132.
- Engine code (EC).
- Radiator fan after-run display.
- Warning and information messages.
- Warning and indicator lamps → page 17.
- Time.
- Multimedia and navigation information.
- Driving data display and menus for various settings.
- Service interval display.
- Start/stop system status display → page 144.

- Road signs detected by the Dynamic Road Sign Display system.
- Display of driver assist systems.
- Speed warnings.
- Personalisation: welcome and user selection → page 41.

 Correspondingly qualified workshops can program and modify other functions depending on the vehicle equipment level. Volkswagen recommends using a Volkswagen dealership.

#### **Open doors, bonnet and boot lid**

The digital instrument cluster indicates if any doors, the bonnet or boot lid are open once the vehicle has been unlocked and while the vehicle is in motion. In some cases, an acoustic warning is also given.

#### **Selector lever position**

The selector lever position is displayed on the side of the selector lever and in the digital instrument cluster.

The digital instrument cluster may show which gear has been selected if the selector lever is in D/S position or in Tiptronic mode.

#### **Outside temperature display**

If the outside temperature falls below approximately +4°C (+39°F), the temperature display also shows a snowflake symbol ❄. This symbol remains lit up until the outside temperature rises above +6°C (+43°F) → .

In the following situation, the temperature displayed may be higher than the actual outside temperature as a result of the heat radiated from the engine.

- When the vehicle is stationary.
- When the auxiliary heater is being used.
- When travelling at very low speeds.

The measuring range is between -45°C (-49°F) and +76°C (+169°F).

#### **WARNING**

Streets and bridges can be iced over at outside temperatures above freezing point.

- The snowflake symbol ❄ indicates that there is a risk of black ice.
- There may also be black ice on the road at outside temperatures above +4 °C (+39 °F) when the snowflake symbol ❄ is not displayed.
- Never rely only on the outside temperature display!

### Telephone information

If a mobile telephone is connected via Bluetooth, the Bluetooth symbol is shown in the digital instrument cluster .

In addition, the  symbol shows the charge level of the mobile phone battery

### Gear-change indicator

While the vehicle is in motion, the digital instrument cluster may show which gear should be selected to reduce fuel consumption → page 131.

### Mileage displays

The odometer registers the total distance travelled by the vehicle.

The trip recorder (trip) shows the distance travelled since the trip recorder was last reset.

1. Reset the trip recorder via the Infotainment system or via the service menu → page 32.

### Speed warning for winter tyres

A display in the digital instrument cluster indicates when you have exceeded the set maximum speed.

Speed warning settings can be made in the vehicle settings in the Infotainment system → page 339.

### Compass display

Depending on the vehicle equipment, the instrument cluster display shows the vehicle's current direction of travel in short form, e.g. NW for north-west, when the ignition is switched on.

The graphic compass display is also available when the Infotainment system is switched on and route guidance is not active.

### Economical mode

When driving, the digital instrument cluster shows whether the vehicle is in an economical mode .

### Engine code

1. Open the Service menu → page 32.

2. Select the Engine code menu option.

### Radiator fan after-run display

This display appears after the vehicle ignition has been switched off if the radiator fan is in after-run mode.

An after-run time of the radiator fan may be caused by the following:

- Exhaust gas treatment, e.g. during particulate filter regeneration.
- Active brake cooling after driving down hills.
- Dissipation of engine heat after vehicle operation under high loads, e.g. trailer towing.

 Some settings can be saved in the user accounts of the personalisation function and can therefore change automatically when the user account is changed → page 41.

 Different instrument clusters are available, which means that the versions and displays may vary. In displays without warning or information texts, faults are indicated exclusively by the indicator lamps.

 Some notifications in the digital instrument cluster may be overridden by sudden events, e.g. incoming telephone calls.

 Depending on the vehicle equipment level, some settings and displays may also appear in the Infotainment system.

 If several warnings are present, the symbols will appear for several seconds, one after another. The symbols will continue to appear until the faults are rectified.

 If warnings about malfunctions are displayed when the ignition is switched on, it may not be possible to adjust some settings as described, or the information display may appear differently. If the fault persists, go to a correspondingly qualified workshop. Volkswagen recommends using a Volkswagen dealership. <

# Analogue instrument cluster

## Overview of analogue instrument cluster

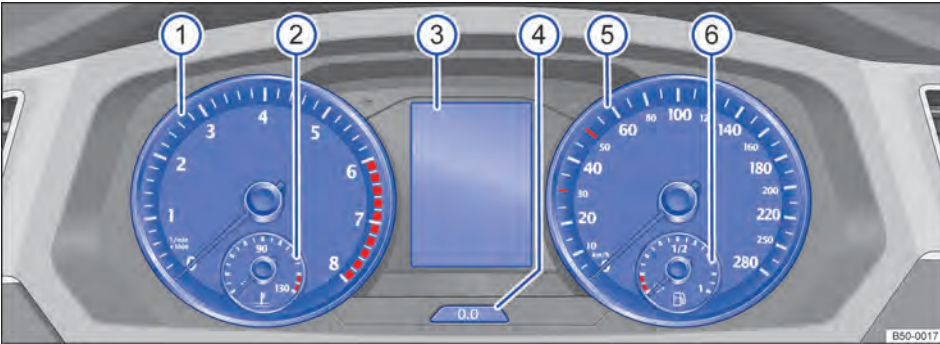

Fig. 14 Analogue instrument cluster in the dash panel.

- ① Rev counter (running engine speed in revolutions x 1,000 per minute).
- ② Coolant temperature display.
- ③ Display → page 21, → page 23, → page 31.
- ④ Reset, set and display button.
- ⑤ Speedometer.
- ⑥ Fuel gauge.

## Operating the analogue instrument cluster



Fig. 15 Right-hand side of the multifunction steering wheel: buttons for using the menus and information displays in the analogue instrument cluster (variant 1).



Fig. 16 Right-hand side of the multifunction steering wheel: buttons for using the menus and information displays in the analogue instrument cluster (variant 2).



**Fig. 17** On the right of the steering column: buttons on the wiper lever.

*Vehicles with multifunction steering wheel:*

If any priority 1 warnings are displayed, you will be unable to open any menus → page 20. You can confirm and hide some warnings using the **OK** → Fig. 15, → Fig. 16 button on the multifunction steering wheel.

*Vehicles without multifunction steering wheel:*

If any priority 1 warning messages are displayed, you will be unable to open any menus. Some warnings can be confirmed and switched off with the → Fig. 17 ① button.

**Selecting the menu or information display**

*Vehicles with multifunction steering wheel:*

1. Switch on the ignition.
2. If a message or the vehicle pictogram is displayed, press the **OK** button, several times if required.
3. Press the **↔** or **⏪** button to display a menu or browse through a menu.
4. To open the menu or information display shown, press **OK** or wait until the menu or information display opens automatically after a few seconds.

*Vehicles without multifunction steering wheel:*

1. Switch on the ignition.
2. If a message or the vehicle pictogram is displayed, press the **OK/RESET** → Fig. 17 ① button on the wiper lever, several times if required.
3. Press and hold the rocker switch **TRIP** → Fig. 17 ② on the wiper lever to display the menus → page 31 or to return to the menu selection from a menu or an information display.
4. To scroll through the menus, press the rocker switch **TRIP** → Fig. 17 ② on the wiper lever at the top or bottom.
5. To open the displayed menu or information display, press the button **OK/RESET** → Fig. 17 ① on

the wiper lever or wait until the menu or information display opens automatically after a few seconds.

**Changing settings in menus**

*Vehicles with multifunction steering wheel:*

1. Press the arrow buttons **▲** and **▼** in the displayed menu until the required menu option is marked.

A frame appears around the selected option.

2. Use the **OK** button to confirm the selection.

A tick  indicates that the respective function is switched on.

*Vehicles without multifunction steering wheel:*

1. In the displayed menu, press the rocker switch **TRIP** → Fig. 17 ② on the wiper lever at the top or bottom until the desired menu option is marked.

A frame appears around the selected option.

2. Press the button **OK/RESET** → Fig. 17 ① on the wiper lever to make the desired changes.

A tick  indicates that the respective function is switched on.

**Returning to menu selection**

*Vehicles with multifunction steering wheel:*

1. Press the button **↔** or **⏪**.

*Vehicles without multifunction steering wheel:*

1. Select the **Back** menu option.

**VIEW button on the multifunction steering wheel**

*Vehicles with multifunction steering wheel:*

You can use the **VIEW** button to switch between the different views in the display area.

1. Press and hold the **VIEW** button to show and hide the secondary displays.

**Mileage displays**

The odometer registers the total distance travelled by the vehicle.

The trip recorder (trip) shows the distance travelled since the trip recorder was last reset.

1. Briefly press the **0.0** button in the analogue instrument cluster to reset the trip recorder to zero.

**Engine code**

1. Switch on ignition, but the engine must not run.
2. Press and hold the **0.0** button on the analogue instrument cluster for around 15 seconds to display the engine code.

**i** If warnings about malfunctions are displayed when the ignition is switched on, it may not be possible to adjust some settings as described, or the information display may appear differently. If the fault persists, go to a correspondingly qualified workshop. Volkswagen recommends using a Volkswagen dealership.

### **⚠ WARNING**

If the driver is distracted when driving, this can cause accidents and serious injuries.

- Never operate the analogue instrument cluster while the vehicle is in motion.
- Drive with your full attention and with responsibility.

## Rev counter

The start of the red zone on the dial indicates the maximum engine speed that may be used in each gear when the engine is warm and after it has been run in properly.

You should change up a gear, select selector lever position D/S or lift your foot off the accelerator before the needle reaches the red zone.

### **! NOTICE**

- When the engine is cold, avoid high engine speeds, driving at full throttle and overloading the engine.
- The needle on the rev counter should only briefly point into the red area, as engine damage may otherwise be incurred.

 Changing up a gear early will help to save fuel and reduce engine noise.

## Fuel gauge

### Digital fuel gauge

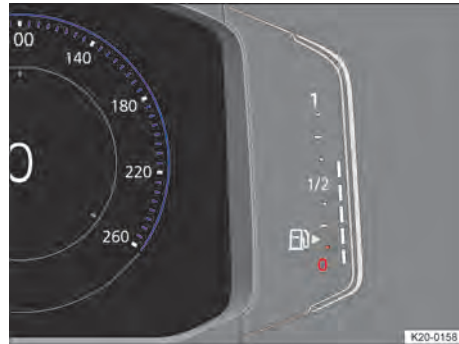

**Fig. 18** Fuel gauge in the digital instrument cluster Pro version (illustration).

### Analogue fuel gauge



**Fig. 19** Fuel gauge in the analogue instrument cluster (illustration).

## Troubleshooting

### Fuel tank almost empty

The indicator lamp lights up yellow. The reserve volume (red marking) is being consumed.

1. Fill the tank as soon as possible.

When the indicator lamp  lights up, the auxiliary heater and the fuel-powered supplementary heater switch off automatically.

## ⚠ WARNING

Driving when the fuel level is too low can lead to the vehicle coming to a standstill in traffic, potentially causing accidents and serious injuries.

- When the fuel level is too low, the fuel supply to the engine could be irregular, especially when driving up or down hills and inclines.
- The steering, all driver assist systems and brake support systems will not function if the engine "sputters" or stops completely due to a lack of fuel or irregular fuel supply.
- To avoid breaking down due to a lack of fuel, always refuel when the fuel tank is only 1/4 full.

## ⓘ NOTICE

Never run the fuel tank completely dry. Irregular fuel supply can cause misfiring and allow unburnt fuel to enter the exhaust system.

### 💧 Water in the diesel fuel

The indicator lamp lights up yellow.

1. Reduce your speed immediately and go to a correspondingly qualified workshop. Volkswagen recommends using a Volkswagen dealership.

**Or:** if the warning lamp lights up immediately after refuelling, 🛑 **Do not drive on!** Switch off the engine and seek expert assistance immediately.

📍 The small arrow next to the petrol pump symbol in the fuel gauge shows you the side of the vehicle on which the tank flap is located.

## Coolant temperature display

### Digital coolant temperature display

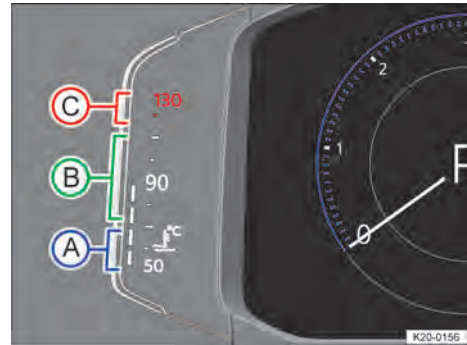

Fig. 20 Coolant temperature display in the digital instrument cluster Pro version (illustration).

- (A) Cold area. The engine has not yet reached operating temperature. Avoid high engine revs and heavy engine loads until the engine is warm.
- (B) Normal area.
- (C) Warning area. The bar may also move into the warning range when the engine is working hard, especially at high ambient temperatures.

### Analogue coolant temperature display



Fig. 21 Coolant temperature display in the analogue instrument cluster (schematic diagram).

- (A) Cold area. The engine has not yet reached operating temperature. Avoid high engine revs and heavy engine loads until the engine is warm.
- (B) Normal area.

- Ⓢ Warning area. The temperature may also rise into the warning range when the engine is working hard, especially at high ambient temperatures.

## Troubleshooting

### ⚠ and 🌊 Coolant

The red central warning lamp ⚠ lights up. A text message is also shown on the instrument cluster display.

**Or:** The 🌊 indicator lamp flashes red.

The coolant level is not correct or there is a fault in the coolant system.

#### 🛑 Do not drive on!

1. Stop the vehicle, switch off the engine and allow it to cool down.
2. Check the coolant level → page 319.
3. Seek expert assistance if the warning lamp does not go out although the coolant level is adequate.

**Or:** if the coolant level is not correct, seek expert assistance immediately.

## Head-up display (HUD)



**Fig. 22** Next to the steering wheel: Head-up Display control (arrow).



**Fig. 23** On the dash panel above the steering wheel: examples of information shown in the Head-up Display.

The head-up display projects selected information or warning messages from the assist systems or the Infotainment system into the driver's field of vision.

### Switching the head-up display on and off

1. Press the control → Fig. 22 to switch the head-up display HUD on or off.

### Adjusting the height

Proceed as follows to adjust the height of the Head-up Display and individually adapt the angle:

1. Assume the correct sitting position.
2. Use the control → Fig. 22 to adjust the height of the head-up display as required.

### Settings in the Infotainment system

You can configure additional settings for the head-up display in the vehicle settings in the Infotainment system.

The following settings are available:

In the **Display** submenu:

- Adjustment of the head-up display brightness and colour scheme.

In the **Contents** submenu:

- Select the content of the head-up display, e.g. to display the driver assist systems, Dynamic Road Sign Display or navigation system.
- Alternative colour scheme of the head-up display for poor weather conditions, e.g. snowfall.

### ⚠ NOTICE

The head-up display may detach from the guide rail as a result of applying excessive pressure, e.g. during cleaning.



- Do not apply excessive pressure when cleaning the head-up display.

### ! NOTICE

To avoid scratching the cover panel, do not place objects in the slot of the Head-up Display.

### ! NOTICE

The system may be switched off automatically if the head-up display is heated up by strong sunlight. The head-up display will switch itself back on again as soon as it has cooled down sufficiently.

 Some content cannot be hidden, e.g. warning messages.

 If the surroundings become darker, the display brightness is automatically dimmed. The basic brightness level is adjusted together with the instrument lighting → page 110.

 Reflections can occur if the incident sunlight strikes the display at an unfavourable angle.

 Sunglasses with polarising filters can negatively affect visual perception of the display.

 The ideal position to read the head-up display depends on the seat position and the height setting of the head-up display.

 Clean the head-up display with a soft cloth and mild detergent only. Microfibre cloths can damage the head-up display.

 Some settings can be saved in the user accounts of the personalisation function and therefore change automatically when the user account is changed → page 41.

## Driving data display (multifunction display)

The driving data display (multifunction display) shows driving and fuel consumption data. Different driving data can be displayed depending on the vehicle equipment level. The displayed driving data depends on the current driving behaviour, the vehicle condition, e.g. particulate filter regeneration, and the current driving situation, e.g. urban driving. The driving data values are determined as average values over route sections of varying length. This means that the currently displayed value may differ from the actual average value.

### Switching between displays

*Vehicles with multifunction steering wheel:*

1. Press the  or  button on the multifunction steering wheel.

*Vehicles without multifunction steering wheel:*

1. Press the rocker switch  on the wiper lever.

### Switching between recorders

*Vehicles with multifunction steering wheel:*

1. Press the  button on the multifunction steering wheel.

*Vehicles without multifunction steering wheel:*

1. Press the  button on the wiper lever.

### Since start recorder

The memory will be deleted if the journey is interrupted for more than 2 hours.

### Since refuelling recorder

Display and storage of the collected driving and consumption values. The memory is deleted when the tank is refilled.

### Long-term recorder

The memory records driving data for up to 19 hours and 59 minutes or 99 hours and 59 minutes of driving time or 1999.9 km (mi) or 9999.9 km (mi) distance covered. The memory is deleted if one of these maximum values is exceeded. The maximum values vary depending on the instrument cluster version.

### Clearing a driving data recorder

*Vehicles with multifunction steering wheel:*





1. Select the memory that you wish to delete.
2. Press the  button on the multifunction steering wheel.

*Vehicles without multifunction steering wheel:*

1. Select the memory that you wish to delete.
2. Press the  button on the wiper lever.

### Setting the speed warning

*Vehicles with multifunction steering wheel:*

1. Select the display Warning at --- km/h or Warning at --- mph.
2. Press the  button on the multifunction steering wheel to save the current speed and activate the warning.
3. Set the speed within approximately 5 seconds using the  and  arrow buttons on the multifunction steering wheel. Then press the  button or simply wait a few seconds.

The speed is now saved and the warning is activated.

4. To deactivate, press the **OK** button again.

The stored speed will be deleted.

*Vehicles without multifunction steering wheel:*

1. Select the display **Warning at --- km/h** or **Warning at --- mph**.
2. Press the **OK/RESET** button on the wiper lever to save the current speed and activate the warning.
3. Within approximately 5 seconds, set the speed using the rocker switch **TRIP** on the wiper lever. Then press the **OK/RESET** button or simply wait a few seconds.

The speed is now saved and the warning is activated.

4. To deactivate, press the **OK/RESET** button again.

The stored speed will be deleted.

The warning can be set for speeds from 30 km/h (18 mph) to 250 km/h (155 mph).

Depending on country, a single acoustic warning will sound at speeds faster than around 80 km/h (around 50 mph) and a continuous acoustic warning from around 120 km/h (around 75 mph). The  indicator lamp also appears in the instrument cluster display. This warning is a legal requirement and cannot be changed.

### Driving data in the Infotainment system

In addition to the display on the instrument cluster, driving data can also be displayed in the Infotainment system.

### Selecting displays

You can select which driving data you want to display in the vehicle settings in the Infotainment system → page 37.

### ∅Average consumption display

The average fuel consumption is displayed after around 300 m (984 ft).

### Range display

Approximate calculation of the distance in km (mi) that the vehicle can still travel under the current driving conditions.

### SCR range or Range display

Approximate calculation of the distance in km (mi) that the vehicle can still travel with the current AdBlue® tank level under the current driving conditions. If it is possible to increase the range by refilling, the required refill amount is also displayed.

### ∅Average speed display

The average speed is displayed after around 100 m (around 328 ft).

## WARNING

If the driver is distracted when driving, this can cause accidents and serious injuries.

- Never operate the instrument cluster while the vehicle is in motion.
- Adjust all settings in the instrument cluster and Infotainment system only when the vehicle is stationary.



Some settings can be saved in the user accounts of the personalisation function and can therefore change automatically when the user account is changed → page 41. 

## Service

### Service menu

Settings can be made in the Service menu depending on the vehicle equipment.

#### Opening the Service menu

1. Select the **Range** information profile on the instrument cluster.
2. Press and hold the **OK** button on the multifunction steering wheel for approximately 4 seconds.
3. Navigate through the menu using the buttons on the multifunction steering wheel.

#### Resetting the service interval display

1. Select the **Service** menu.
2. Observe the instructions on the instrument cluster display.

#### Resetting the oil service

1. Select the **Reset oil service** menu.
2. Observe the instructions on the instrument cluster display.

#### Resetting the trip recorder



1. Select the **Reset trip** menu.
2. Observe the instructions on the instrument cluster display.

#### Displaying the engine code

1. Select the **Engine code** menu.

The engine code is displayed on the instrument cluster.

### Setting the time

1. Select the **Time** menu.
2. Set the time with the arrow buttons  and .

### Displaying copyright information

1. Select the **Copyright** menu to access copyright information. 

## Service interval display

Service events are displayed on the instrument cluster and in the Infotainment system. Versions and displays can vary as different versions of the instrument cluster and Infotainment system are available.

Service schedules at Volkswagen are divided into two categories, oil change service and inspections. The service interval display provides information on the next service which includes an oil change and on the next scheduled inspection.

In vehicles with fixed oil change service interval, services take place at predefined intervals.

The service intervals are calculated on an individual basis in vehicles with flexible oil change service interval. An oil change service must be carried out only when required by the vehicle. The individual conditions in which the vehicle is used and the driver's personal driving style are taken into account. The service reminder is displayed for the first time 30 days before the calculated oil change service is due. The distance is rounded to the nearest 100 km (mi) and the remaining time is rounded to full days.

### Service notification

If an oil change service or inspection is due soon, a service alert will appear the next time the ignition is switched on.

The number of kilometres or amount of time shown correspond to the maximum number of kilometres or maximum time that can still be driven before the next service.

### Service event

For a scheduled oil change service or a scheduled inspection, an acoustic warning will sound when the ignition is switched on and the spanner symbol  will be displayed for several seconds on the instrument cluster display. One of the following displays will also appear:

- Inspection now!
- Oil service now!

— Oil service and inspection now!

### Accessing service schedules in the Infotainment system

You can access the current scheduled service event when the ignition is switched on, the engine is not running, and the vehicle is stationary:

*To access the service schedule in the Infotainment system:*

1. Depending on the version, press the **MENU** button or function button and select the **Vehicle** menu in the Infotainment system.

**Or:** press the **CAR** button or function button, depending on the version.

2. Depending on the version, select the **Settings** menu.
3. Select the **Service** menu option to display the service information.

### Accessing service schedules in the analogue instrument cluster

1. Press and hold the **0.0** button in the instrument cluster until the text **Service** appears on the display.
2. Release the **0.0** button.

The current scheduled service will be shown in the display.

### Accessing service schedules in the digital instrument cluster Pro version

You can access the current scheduled service event when the ignition is switched on, the engine is not running, and the vehicle is stationary:

1. Open the **Service** menu → page 32.

### Resetting the service interval display

If the service interval display was not reset after the oil change service or inspection, the display can be reset as follows:

*Vehicles with analogue instrument cluster:*

1. Switch off the ignition.
2. Press and hold the **0.0** button in the instrument cluster.
3. Switch on the ignition again.
4. Release the **0.0** button when one of the following messages appears on the instrument cluster display: **Reset oil service?** or **Reset inspection?**
5. Press the **0.0** button on the instrument cluster to confirm.

*Vehicles with digital instrument cluster:* The service interval display can only be reset via the **Service** menu → page 32.

Do not reset the service interval display between service intervals – otherwise incorrect data may be shown.

If the oil change service interval was reset manually, the service interval display then also changes to a fixed service interval in vehicles with flexible oil change service interval.

 The service message will go out automatically after a few seconds when the engine is running, or when you press the **OK** button on the multifunction steering wheel.

 If the 12-volt vehicle battery was disconnected for long periods in vehicles with flexible service interval, the system cannot calculate the time at which the next oil change service is due. The information shown in the service interval display may therefore be incorrect. In this case, observe the maximum permissible maintenance interval. <

## Time

### Setting the time in the Infotainment system

1. Depending on the version, press the **MENU** button or function button and open the **Vehicle** menu in the Infotainment system.  
**Or:** press the **CAR** button or function button, depending on the version.
2. Depending on the version, open the **Settings** menu.
3. To set the time, select the **Time and date** menu option.

### Setting the time in the digital instrument cluster Pro version

1. Select the **Range** information profile.
2. Press and hold the **OK** button on the multifunction steering wheel until the **Service** menu is available on the instrument cluster display → page 32.
3. Select the **Time** menu.
4. Set the correct time with the arrow buttons **Δ** or **▽**.

### Setting the time in the analogue instrument cluster

1. To set the time on all vehicle clocks, press and hold the **0.0** button in the analogue instrument cluster until the text **Time** appears in the instrument cluster display.
2. Release the **0.0** button.  
The time is shown in the instrument cluster display and the hour setting is marked.
3. Press the **0.0** button repeatedly until the desired number of hours is displayed.  
Press and hold the **0.0** button to scroll through quickly.  
After a few seconds, it automatically switches to the minute display in the instrument cluster display.
4. Press the **0.0** button repeatedly until the desired number of minutes is displayed.  
Press and hold the **0.0** button to scroll through quickly.
5. Release the **0.0** button to finish setting the time. <

## Sports displays

### Lap timer in the Infotainment system



Fig. 24 On the Infotainment system display: lap timer with stopwatch, function button and lap times.

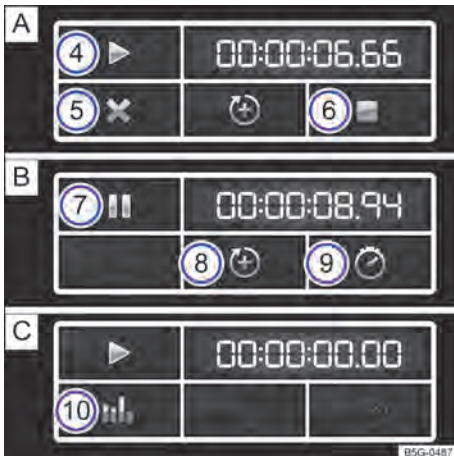

Fig. 25 Function button on the Infotainment system display: time measurement for **A**) paused, **B**) current and **C**) completed lap.

- ① Stopwatch.
- ② Function button with current lap time.
- ③ Stored lap times.
- ④ Start or continue time measurement. This is possible only when the ignition is switched on. Tap **Start** to start time measurement. Time measurement starts automatically as soon as the vehicle moves forwards. A new first lap can be started when the data in the statistics has been reset.

- ⑤ Cancel current lap. The lap time is deleted. --:--:-- is displayed in the statistics.
- ⑥ End time measurement.
- ⑦ Pause time measurement or cancel current lap (when time measurement is running).
- ⑧ Start new lap. The last lap time is stored and a new lap starts. The overall time of the laps driven is shown in the statistics.
- ⑨ Display split time. The stopwatch stops for a few seconds and the split time is displayed.
- ⑩ Display statistics after ending or aborting time measurement: number of laps, overall time, fastest and slowest slaps, average value of all lap times, all lap values. Tap **Reset** to reset the statistics.

**i** A maximum of 99 laps and a maximum time of 99 hours, 59 minutes and 59 seconds can be recorded. If one of these limits has been reached, the data in the statistics must be deleted before a further time measurement.

#### Opening the lap timer

1. Press the **(MENU)** button or function button, depending on version.  
Or: press the **(CAR)** button or function button.  
Or: tap the **(CAR)** function button.
2. Tap the **(Vehicle)** function button.  
Or: tap the **(Auto)** function button.
3. Tap the **(Selection)** function button.
4. Tap the **(Sport)** function button.  
The performance monitor is displayed.

- Tap one of the arrow buttons in the performance monitor to switch to the lap timer.

You can change between the lap timer and performance monitor at any time using the arrow buttons.

### Measuring lap times

The stopwatch measures the lap time in two areas:

The red needle and the numerical value in the centre show the running time in seconds. The smaller display in the inner area shows minutes and hours.

The display on the right side shows the current lap time with an accuracy of 1/100 seconds. There is no

difference between the stopwatch and lap times if there are not yet any laps with split times stored in the lap timer.

### ⚠ WARNING

Accidents and injuries can occur if the driver is distracted.

- Adjust the lap timer settings and access statistics only when the vehicle is stationary.
- When the vehicle is in motion, use the lap timer only in driving situations which are easy to control.

## Performance monitor

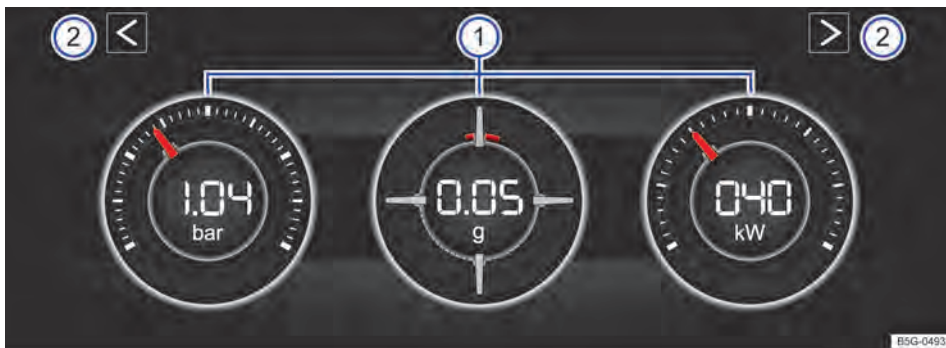

Fig. 26 On the Infotainment system display: performance monitor.

- Display areas.
- Arrow buttons for changing to the lap timer.

The performance monitor is a display for sporty driving. The digital instruments display real-time values for engine power, temperature and acceleration that are determined by sensors on the vehicle. This provides the driver with an overview of driving dynamics.

### Opening the performance monitor

- Press the **MENU** button or function button on the Infotainment system, depending on version.
- Tap the **Vehicle** function button.
- Tap the **Selection** function button.
- Tap the **Sport** function button.

If you would like to switch between the performance monitor and the lap timer, tap one of the arrow

buttons on the left and right above the instruments → Fig. 26 ②.

### Selecting instruments and setting units

The display can show a maximum of three instruments at the same time. Each instrument can be selected for each display area → Fig. 26 ① (left, middle, right).

- To change between instruments, swipe vertically over the display.

The currently selected instrument will then disappear and a new instrument will appear.

The units of measurement can be adjusted for some instruments in the Infotainment system → page 37.

### The following instruments can be displayed:

- **Charge pressure display:** the charge pressure display → Fig. 26 ① (left) shows the pressure in the charge air system between the turbocharger and engine in bar. The further to the right the needle on the scale, the higher the engine power output.

- **Accelerometer (G-meter):** the accelerometer (G-meter) → Fig. 26 ① (centre) shows the acceleration value in the centre in g. The red marking in the grid-type area shows the acceleration level and the direction of the acting force. The force acts in the opposite direction according to physical laws. If you drive to the left, for example, the red marking will move in the right area of the instrument and vice versa. If you accelerate, the red marking will move down. If you brake, the red marking will move up. The level of acceleration is indicated by the position of the red marking which moves outwards. If the acceleration increases, the red marking will move away from the centre area.
- **Power display:** the power display → Fig. 26 ① (right) shows the current engine power output as a digital value and on the surrounding scale in kW.
- **Coolant temperature display:** the needle may move further in a clockwise direction under high engine loads and with high outside temperatures. This is no cause for concern as long as the  indicator lamp in the instrument cluster display does not light up or flash → page 319.
- **Oil temperature display:** the needle is in the middle area under normal driving conditions. If the needle is in the bottom left area, this means that the engine has not yet reached its operating temperature. Avoid excessively high speeds and ac-

celeration when the engine has not yet reached its operating temperature. The needle may move further in a clockwise direction under high engine loads and at high outside temperatures. This is no cause for concern as long as the  indicator lamp in the instrument cluster display does not light up or flash → page 317.

### Adapting the display areas to the driving situation

Choose the three possible instruments corresponding to your individual driving style and the driving situation.

#### **WARNING**

Accidents and injuries can occur if the driver is distracted. Operating the Infotainment system can distract you from the road.

- Drive with your full attention and with responsibility.

#### **NOTICE**

After starting the engine from cold, avoid high engine speeds, driving at full throttle and overloading the engine.

 Due to the principle of performance determination used in the vehicle, the physical accuracy of the displayed values is not guaranteed. <

## Vehicle settings menu

You can switch individual functions and systems on and off and adjust the settings in the vehicle settings of the Infotainment system.

### General information on operation

The following section contains relevant information on the settings that can be adjusted in the Vehicle settings menu.



A tick  indicates that the relevant function is switched on.

### Opening the Vehicle settings menu

1. Switch on the ignition.
2. Switch on Infotainment system if necessary.
3. Depending on the design, press the  button or function button and select the Vehicle menu.

**Or:** depending on the version, press the  button or function button and select the Settings menu.

**Or:** tap the  function button and select the Auto menu.

4. Tap the corresponding function buttons to open additional menus in the Vehicle settings menu or tap the  function button and select the corresponding function buttons to adjust the settings in the menu options.
5. To return to the previous menu, tap the  function button.

### Systems settings and vehicle information display

Depending on the version, information can be displayed or settings adjusted in the Vehicle settings menu:

- Vehicle settings (Settings).
- Depending on equipment: Think Blue. Trainer → page 134.
- Depending on equipment: performance monitor → page 36.
- Depending on equipment: lap timer → page 35.
- Offroad display → page 159.
- Auxiliary heater settings → page 126.

- Digital instrument cluster (Pro version)  
→ page 21, → page 23.
- Active media.
- Driving data.
- Vehicle status.
- Radio station selection.

 When you start the engine after the 12-volt vehicle battery has been totally discharged, replaced or after a jump start, you may find that system settings, such as personal convenience settings and programming, have been changed or deleted. Check and correct the settings as necessary once the 12-volt vehicle battery has been sufficiently charged.

### WARNING

Accidents and injuries can occur if the driver is distracted. Operating the Infotainment system can distract you from the road.

- Drive with your full attention and with responsibility.

## Driver Alert System

### Introduction to the topic



**Fig. 27** On the instrument cluster display: Driver Alert System symbol.

The Driver Alert System informs the driver if their driving shows signs of tiredness.

The Driver Alert System determines the driving behaviour at the beginning of a journey and uses it to evaluate the tiredness of the driver. This is compared to the behaviour of the driver while actually driving. If the system detects driver fatigue, an acoustic warning signal will sound and a symbol will be displayed on the instrument cluster display together with a supplementary text message → Fig. 27. The message on the instrument cluster display appears for about 5 seconds and may be re-

peated once. The last displayed message is saved by the system.

### Function conditions

The driving behaviour can be evaluated only when the speed is above around 60 km/h (around 37 mph) up to approximately around 200 km/h (around 125 mph).

### WARNING



The intelligent technology used in the Driver Alert System cannot overcome the laws of physics, and functions only within the limits of the system. Do not let the extra convenience afforded by the Driver Alert System tempt you into taking any risks when driving. During a long trip, plan regular and sufficient breaks.

- The driver is responsible at all times for their fitness to drive.
- Never drive a vehicle when you are tired.
- The system cannot always detect the driver's level of alertness. Observe the information in the section on the limits of the Driver Alert System.
- In certain situations, the system may wrongly interpret intentional driving manoeuvres as a lack of alertness from the driver.
- No urgent warning will be given in the event of the phenomenon known as microsleep.
- Follow the information in the instrument cluster display, and respond according to the commands.

 The Driver Alert System has been developed for use only while driving on motorways and good roads.

 In the event of a fault, have the system checked by a correspondingly qualified workshop. Volkswagen recommends using a Volkswagen dealership.

### Limits of the Driver Alert System

 Please refer to  at the start of the chapter on page 38.

The Driver Alert System has system-related limitations. The following conditions can limit the function of the Driver Alert System, or prevent it from working altogether:

- When travelling at speeds of less than approximately 60 km/h (around 37 mph).



- When travelling at speeds of more than approximately 200 km/h (around 125 mph).
- Twisting roads.
- Poor roads.
- Adverse weather conditions.
- Sporty driving style.
- Towing a heavy or long trailer → page 273.
- The driver is distracted.

The Driver Alert System is reset in the following situations:

- The ignition is switched off.
- The driver seat belt is unfastened and the driver door is open.
- The vehicle has been stationary for longer than around 15 minutes.

The Driver Alert System is automatically reset in the event of an extended period of slow driving at a speed of less than around 60 km/h (around 37 mph). If the speed is increased again, the system evaluates the driving behaviour once more.

## Operating the Driver Alert System

📖 Please refer to ⚠️ at the start of the chapter on page 38.

### Hiding a message

The message on the instrument cluster display can be hidden as follows or will disappear on its own after 5 seconds:

*Vehicles without multifunction steering wheel:*

1. Press the **OK/RESET** button on the wiper lever.

*Vehicles with multifunction steering wheel:*

1. Press the **OK** button on the multifunction steering wheel.

### Switching on and off

You can switch the Driver Alert System on and off in the **Assist systems** menu in the Infotainment system → page 31.

👤 The Driver Alert System is switched on automatically when the engine is started.

## Dynamic Road Sign Display

### Introduction to the topic

Dynamic Road Sign Display uses a camera in the base of the interior mirror to monitor standard road signs and informs the driver of any detected speed limits or overtaking restrictions. Within the limits of the system, the system also displays sub-plates, e.g. temporary restrictions or restrictions in wet conditions. In some cases, the system can also display the current speed limits on non-signposted routes.

In addition to speed limits and overtaking restrictions, Dynamic Road Sign Display also detects the road sign which indicates that all restrictions have been lifted on motorways and main roads in Germany. In all other countries in which the system is operated, the current speed limit is displayed instead.

◀ The road signs detected by the Dynamic Road Sign Display function are displayed on the instrument cluster display and on the Infotainment system.

With some equipment levels, a display is also shown on the Head-up Display.

### Display of road signs



Fig. 28 On the instrument cluster display: example displays of the Dynamic Road Sign Display function.



**Fig. 29** On the instrument cluster display: example displays of the Dynamic Road Sign Display function.

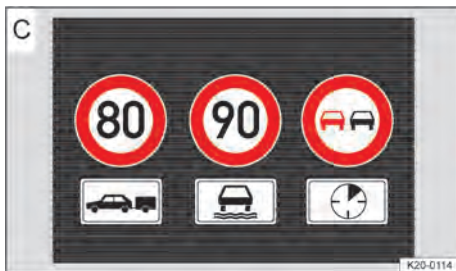

**Fig. 30** On the instrument cluster display: example displays of the Dynamic Road Sign Display function.

After validation and evaluation of the information from the camera, the Infotainment system and the current vehicle data, the activated Dynamic Road Sign Display shows up to three valid road signs with the accompanying sub-plates → Fig. 28, → Fig. 29, → Fig. 30:

- 1st position:** The road sign that currently applies to the driver is shown on the left-hand side of the display, e.g. a speed limit of 130 km/h (80 mph).
- 2nd position:** Road signs that do not always apply (e.g. 100 km/h (60 mph) "when wet") are shown in second place.
- Sub-plate:** if the windscreen wiper is active while the vehicle is in motion, the applicable road sign with the "when wet" sub-plate will be moved left to the first position, for example.
- 3rd position:** A further road sign can be displayed in the third position, e.g. "overtaking not permitted at certain times".

### **⚠ WARNING**

The intelligent road sign recognition system technology cannot overcome the laws of physics, and functions only within the limits of the system. Do not let the extra convenience afforded by Dynamic Road Sign Display tempt you into taking any risks

when driving. The system is not a substitute for the full concentration of the driver.

- Always adapt your speed and driving style to the current visibility, weather and road or traffic conditions.
- Poor visibility, darkness, snow, rain and fog can cause traffic signs to be not displayed or be incorrectly displayed by the system.
- If the camera's field of view is dirty, covered or damaged, the function of the Dynamic Road Sign Display system may be impaired.

### **⚠ WARNING**

Driving recommendations and traffic symbols displayed by the Dynamic Road Sign Display system may differ from the current traffic situation.

- Not all road signs can be recognised by the system and displayed correctly.
- Road signs on the road and traffic regulations have priority over the recommendations and displays provided by the Dynamic Road Sign Display system.

### **ⓘ NOTICE**

Availability of the Dynamic Road Sign Display function is limited in waypoint mode (waypoint navigation) of the Infotainment system.

**ⓘ** Some settings can be saved in the user accounts of the personalisation function and can therefore change automatically when the user account is changed → page 41.

## **Limits of Dynamic Road Sign Display**

**📖 Please refer to ⚠ and ⓘ at the start of the chapter on page 39.**

### **Error messages**

**No road signs available.** The system is in the initialisation phase.

**Or:** the camera has not detected any regulatory or warning signs.

**Error: Dynamic Road Sign Display System fault.** If the fault persists, go to a correspondingly qualified workshop. Volkswagen recommends using a Volkswagen dealership.

**Speed warning currently not available.** Fault in the Dynamic Road Sign Display system speed warning. If the fault persists, go to a correspondingly qualified workshop. Volkswagen recommends using a Volkswagen dealership.

**Dynamic Road Sign Display: Clean the windscreen!** The windscreen is dirty in the area of the camera or the camera view is impaired due to the weather conditions. Clean the windscreen.

**Dynamic Road Sign Display is currently restricted.** No data transmission from the Infotainment system. Check to ensure that valid map data is loaded in the Infotainment system.

**Or:** the vehicle is located in an area that is not covered by the map stored in the Infotainment system.



**No data available.** Dynamic Road Sign Display is not supported in the country in which you are currently travelling.

### Function limitations

Dynamic Road Sign Display is subject to system-related limitations. The following conditions can restrict the function of Dynamic Road Sign Display, or prevent it from working altogether:

- Poor visibility, for example when it snows.
- Glare, e.g. from oncoming traffic or sunlight.
- High speeds.
- A covered or dirty camera.
- Road signs located outside of the camera's field of view.
- Partially or fully hidden road signs, e.g. by trees, snow, dirt or other vehicles.
- Non-standard road signs.
- Damaged or bent road signs.
- Variable road signs on gantries (changeable road sign display using LEDs or other light sources).
- Out-of-date map material in the Infotainment system.
- Vehicles with road sign stickers, e.g. speed restrictions on trucks.

## Operating the Dynamic Road Sign Display function

📖 Please refer to  and  at the start of the chapter on page 39.

### Switching on and off

Continuous display of road signs in the instrument cluster can be switched on and off in the vehicle settings in the Infotainment system.

### Speed warning

If the Dynamic Road Sign Display detects that an applicable speed limit has been exceeded, it can issue

an acoustic warning signal or display a message on the instrument cluster display.

The speed warning can be set or completely deactivated in the vehicle settings in the Infotainment system → page 37. The settings can be adjusted in increments of 5 km/h (3 mph) within a range between 0 km/h (mph) and 10 km/h (5 mph) above the permitted maximum speed.

### Trailer mode

In vehicles with a factory-fitted towing bracket and a trailer with an electrical connection to the vehicle, the display of road signs that may apply to the vehicle when towing a trailer, e.g. applicable speed limits and no-overtaking signs, can be activated or deactivated in the vehicle settings in the Infotainment system → page 37.

In trailer mode, the speed warning function display can be adjusted to the type of trailer or to legal requirements. The settings can be adjusted in increments of 10 km/h (5 mph) within a range between around 60 km/h (40 mph) and around 130 km/h (80 mph). If a higher speed is set than is permitted for driving with a trailer in the country in which you are currently travelling, Dynamic Road Sign Display automatically issues a warning at the usual speed limit, e.g. at around 80 km/h (50 mph) in Germany.

If the speed warning for the trailer is deactivated, Dynamic Road Sign Display issues warnings as if the vehicle was being driven without a trailer. 

## Personalisation

### Personalisation

 The personalisation function allows personalised vehicle settings, such as air conditioning system settings, to be saved in a We Connect user account. User identification takes place when logging on to your We Connect user account in the Infotainment system.

Changes to the settings are assigned to the user account active in the vehicle and are automatically saved online in the We Connect user account via an existing internet connection.

### Welcome and user account selection

After switching on the ignition, the name of the identified user appears in the Infotainment system. If automatic key assignment is activated, the user is identified via the vehicle key. If automatic key assignment is not active, the last user logged in to the vehicle is always displayed.

If you are not the identified user, you have the following options:

- Select your own user account from the user list if you were already logged in to the vehicle.
- Log in to your We Connect user account with your access details in order to add your user account to the user list.
- Create a new user account directly from the vehicle if you are not yet registered with We Connect.

If you do not wish to log in to We Connect or register, a guest user account is available in the Infotainment system. The current vehicle settings are retained when switching to the guest user account.

After you have logged in, the vehicle settings saved online are loaded and activated in the vehicle. When you log in to a vehicle with your user account for the first time, the factory settings are applied.

 If the car has seats with memory function, you can manually cancel transfer of the corresponding setting in the Infotainment system display.

### User management and settings

When the ignition is switched on, you can use the user management menu in the Infotainment system for user management and to select the settings. Here new users can log in or register and you can remove saved user accounts from the Infotainment system's memory → page 223.

Opening the user administration menu:

1. Tap .

Opening the settings menu:

1. In the user administration menu, tap .

### Switching user account

You can select the user account via the user administration menu. Here you can activate another available user account in the vehicle, log into an existing We Connect user account, or register with We Connect using a new user account.

### Automatically assigning vehicle keys to user accounts

If you have selected **Automatic** key assignment, the following vehicle key is assigned to the user account upon changing the user account:

- *Vehicles without Keyless Access*: vehicle key used to unlock the vehicle.
- *Vehicles with Keyless Access*: vehicle key that is identified first by the personalisation function when the driver door is opened.

If automatic key assignment is deactivated, the vehicle key assignment is also deleted. When the Info-

tainment system is switched on, the last active user in the vehicle is always displayed.

### Synchronising vehicle settings

Vehicle settings changed in the vehicle are automatically assigned to the active user account and are stored online on a cyclical basis. The vehicle settings are also automatically synchronised with the data stored online in the following situations when an Internet connection has been established:

- When the ignition and Infotainment system are switched on: synchronises all user accounts stored in the vehicle that have recently been used.
- When switching to another user account: synchronises the newly activated user account and the user account that has now been deactivated.
- At the end of the journey and when the ignition is switched off: synchronises the last active user account.

You can also start the synchronisation manually in the user administration menu at any time, e.g. if automatic synchronisation fails when logging in. Synchronisation cannot take place automatically if the online status of the vehicle is impaired, e.g. in underground garages, or if you have activated the "maximum privacy settings" mode.

 If an inactive user account is active in another vehicle and settings are synchronised from there, these settings are also transferred to your vehicle and assigned to the corresponding user account.

### Personalised vehicle settings

The vehicle functions that can be configured depend on the equipment level. Some personalisable functions are not stored online, but are only assigned to the user account locally in the vehicle. The following functions can be personalised:

- Opening and closing (single door unlocking, convenience opening, windows).
- Wiper settings.
- Seat settings.
- Light and vision (daytime running lights, dipped beam switch-on times, convenience turn signal).
- Air conditioning system settings.
- Active driver assist systems.
- Driving profile selection.
- Multifunction display and instrument cluster (selection of displays).
- Head-up Display. 

# Safety

## Sitting position

### Introduction to the topic

#### Number of seats

The vehicle has a total of five seats: two at the front and three at the rear.

Each seat is equipped with a seat belt.

Assuming an incorrect sitting position considerably impairs the level of protection provided by a seat belt. This could lead to severe or even fatal injuries. The risk of severe or fatal injuries is especially increased when a deploying airbag strikes a vehicle occupant who has assumed an incorrect sitting position. The driver is responsible for all occupants transported in the vehicle, especially children.

#### **WARNING**

Assuming an incorrect sitting position in the vehicle can increase the risk of severe or fatal injuries during a sudden driving or braking manoeuvre, in the event of a collision or accident, or if the airbags are triggered.

- All vehicle occupants must assume a correct sitting position before setting off and maintain this position throughout the trip. This also applies to the fastening of seat belts.
- The number of vehicle occupants must never exceed the number of seats with seat belts in the vehicle.
- Never tilt the backrest too far to the rear.
- Always keep your feet in the footwell during the journey. Never place your feet on the seat or dash panel, for example. Never hold your feet out of the window. If you sit like this, the airbag and seat belt cannot provide optimal protection and could actually increase the risk of injury during an accident.

### Correct sitting position

Please refer to **▲** at the start of the chapter on page 43.

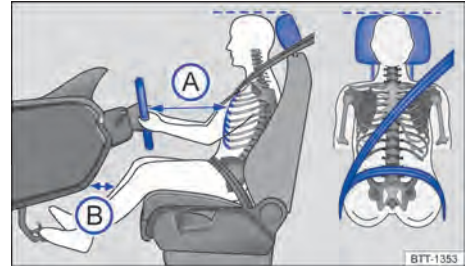

**Fig. 31** Schematic diagram: Correct distance between the driver and the steering wheel, correct seat belt routing and correct head restraint adjustment.

The following describes the correct sitting positions for the driver and passengers.

If any vehicle occupants cannot assume a correct sitting position due to their physical build, they should contact a correspondingly qualified workshop to find out about possible special modifications. The seat belts and airbags can only provide a maximum level of protection if a correct sitting position is assumed. Volkswagen recommends using a Volkswagen dealership for this purpose.

Volkswagen recommends the following seating position for your own safety and to reduce the level of injury in the event of a sudden braking manoeuvre or an accident:

#### The following applies to all vehicle occupants:

- Adjust the head restraint so that its upper edge is at the same height as the top of the head, but not lower than eye level. Position the back of your head as close to the head restraint as possible at all times → Fig. 31.
- For small people, push the head restraint all the way down, even if the head is then located underneath the top edge of the head restraint.
- For tall people, push the head restraint up as far as it will go.
- Always keep both feet in the footwell.
- Adjust and fasten seat belts properly → page 44.

#### Additional points for the driver:

- In vehicles with head restraints that are adjustable longitudinally, position the head restraint as close as possible to the back of your head.

- Adjust the seat so that the distance between the steering wheel and your breastbone is at least 25 cm (around 10 inches) → Fig. 31 A and the circumference of the steering wheel can be held at the sides with both hands and your arms slightly bent.
- The steering wheel must always point towards the breastbone and not towards the face.
- Move the backrest into an upright position so that your back rests fully against it.
- Adjust the driver seat by moving it forwards or backwards so that you are able to press the pedals to the floor with your knees still slightly bent and so that the distance from the dash panel to your knees is at least 10 cm (around 4 inches) → Fig. 31 B.
- Adjust the height so that you can reach the high-point of the steering wheel.

#### Additional points for the front passenger:

- In vehicles with head restraints that are adjustable longitudinally, position the head restraint as close as possible to the back of your head.
- Move the backrest into an upright position so that your back rests fully against it.
- Push the front passenger seat as far back as possible so that the airbag can provide maximum protection if it is deployed. ◀

## Seat belts

### Introduction to the topic

If worn properly, seat belts hold the vehicle occupants in the correct sitting position during an accident or braking manoeuvre, providing maximum protection.

### WARNING

Incorrectly fastened or unfastened seat belts can increase the risk of severe or fatal injuries.

- Before every trip, each vehicle occupant must adopt the correct sitting position, correctly fasten the seat belt belonging to their seat and keep it fastened properly throughout the trip.
- Before every journey and while the vehicle is in motion, secure all children travelling in the vehicle in a restraint system suitable for their weight and height. They must also wear correctly fastened seat belts → page 58.

- Insert the latch plate only into the belt buckle of the corresponding seat and make sure that the latch plate engages securely. Using a buckle that does not belong to the seat that you are occupying reduces the level of protection and can lead to severe injuries.
- Never unfasten the seat belt while the vehicle is in motion.
- Never allow more than one person to share the same seat belt.
- Never transport children or babies on your lap and never secure them using the same seat belt.
- Never travel wearing loose, bulky clothing (such as an overcoat over a jacket). This could prevent the seat belts from fitting and functioning properly.

### WARNING

Damaged seat belts increase the risk of serious or fatal injuries. If the belt webbing or any other part of the seat belt becomes damaged, the seat belt may tear during an accident or sudden braking manoeuvre.

- Never damage the belt by trapping it in the door or in the seat mechanism.
- If the belt webbing, belt connections, belt retractor or seat belt buckle become damaged, the seat belt or belt attachment element in question must be replaced immediately by a correspondingly qualified workshop. The correspondingly qualified workshop must use correct spare parts that are compatible with the vehicle, equipment level and model year. Volkswagen recommends using a Volkswagen dealership.
- Never try to repair, modify or remove the seat belts or belt attachment elements yourself. All repairs to the seat belts, belt retractors and buckles must be carried out by a correspondingly qualified workshop. The correspondingly qualified workshop must replace the seat belt only with a seat belt that is approved for the seat in question. Volkswagen recommends using a Volkswagen dealership.
- Have seat belts that have been subjected to stress and stretched during an accident replaced by a correspondingly qualified workshop. Volkswagen recommends using a Volkswagen dealership. Renewal may be necessary even if there is no apparent damage. Also check the anchorages of the seat belts.

## ⚠ WARNING

Using seat belts incorrectly increases the risk of severe or fatal injuries.

- Regularly check to ensure that the seat belt and its related parts are in perfect condition.
- Always keep the seat belts clean.
- Avoid allowing foreign bodies or liquids to enter the seat belt buckle slots and belt buckles. This could prevent the seat belt buckle slots, belt buckles and seat belts from working properly.
- Never trap the seat belt. Never damage the belt or allow it to rub against sharp edges.

## Buckle-up request and belt status display

📖 Please refer to ⚠ at the start of the chapter on page 44.



**Fig. 32** On the instrument cluster display: warning lamp.

### Buckle-up request for the front seats

If the driver or front passenger seat is occupied by an adult, an acoustic warning will be emitted for 126 seconds if the seat belts are not fastened at the start of a journey and the vehicle reaches a speed of more than approximately 25 km/h (15 mph) or if the seat belts are unfastened while the vehicle is in motion. The red ⚠ warning lamp also flashes on the instrument cluster display.

The red ⚠ warning lamp will not go out until all occupants have fastened their seat belts when the ignition is switched on.

### Fasten seat belt prompt for the rear seats (depending on country and equipment)

When the ignition is switched on, the seat belt warning system shows the driver in the instrument cluster display whether or not the rear passengers have fastened their seat belts.



The symbol indicates that the passenger on this seat has fastened "their" seat belt.



The symbol indicates that this seat is not occupied.

If a rear seat belt is unfastened when the vehicle is in motion, the ⚠ and ⚠ symbols for this seat will flash alternately, depending on the instrument cluster version. The red ⚠ warning lamp also flashes on the instrument cluster display. If the vehicle is travelling faster than approximately 25 km/h (15 mph) an acoustic signal will also be given for 126 seconds.

## ⚠ WARNING

The buckle-up request is designed to detect adult persons. If a seat is occupied by lighter persons, in particular children, the detection will not be reliable. The buckle-up request also does not respond or only in a limited way if child seats and seat supports are used.

- Always ensure that all vehicle occupants, especially children, have fastened their seat belts properly.

## Fastening and unfastening seat belts

📖 Please refer to ⚠ at the start of the chapter on page 44.

### Fastening the seat belt



**Fig. 33** Inserting the seat belt latch plate into the buckle.

1. Adopt correct sitting position → page 43.
2. Take hold of the belt and pull it evenly across your chest and pelvis. Do not twist the belt when doing this → page 46.
3. Insert the latch plate securely into the buckle belonging to the occupied seat → Fig. 33.

- Pull on the seat belt to ensure that the latch plate is securely locked in the buckle.

### Unfastening the seat belts



**Fig. 34** Removing the latch plate from the buckle.

Unfasten seat belts only when the vehicle is stationary → page 46, *Seat belt routing*.

- Press the red button in the buckle → Fig. 34.  
The latch plate is released and springs out.
- Guide the belt back by hand so that it rolls up easily, without twisting the seat belt and without damaging the trim.

### Twisted seat belt

If it is difficult to remove the seat belt from the belt guide, the seat belt may have become twisted if it was returned too quickly into the side trim:

- Take hold of the latch plate then slowly and carefully pull out the seat belt.
- Untwist the seat belt and guide it back slowly by hand.
- Fasten the seat belt even if you are unable to undo the twist.

However, the twist should not be in part of the seat belt that comes into direct contact with the body.

- Go immediately to a correspondingly qualified workshop in order to have the twist undone. Volkswagen recommends using a Volkswagen dealership.

## Seat belt routing

📖 Please refer to ⚠ at the start of the chapter on page 44.

Seat belts only provide an optimum level of protection during an accident when they are routed correctly. Correct seat belt routing reduces the risk of severe or fatal injuries. Correct seat belt routing also

holds the vehicle occupants in position so that an inflating airbag can offer the maximum level of protection. Therefore you must always fasten your seat belt and ensure that the seat belt routing is correct → Fig. 35.

### Correct seat belt routing

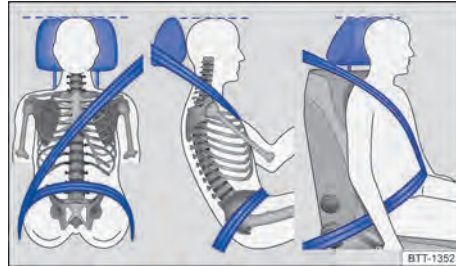

**Fig. 35** Correct seat belt routing and head restraint adjustment.

- The shoulder belt must always lie on the centre of the shoulder, never across the neck, over or under the arm or behind the back.
- The lap belt must always lie across the pelvis, never across the stomach.
- The seat belt must always lie flat and snugly on the body. Tighten the belt if necessary.

### Correct seat belt routing during pregnancy



**Fig. 36** Correct seat belt routing during pregnancy.

For pregnant women, the seat belt must be positioned evenly over the chest and as low as possible over the pelvis. It must lie flat so that no pressure is exerted on the lower body – this applies for the entire course of the pregnancy → Fig. 36.

### Correct seat belt routing according to height

The following equipment can be used to adjust the seat belt routing:



- Seat belt height adjuster for the front seats → page 47.
- Height-adjustable front seats → page 43.

### **! WARNING**

Incorrect seat belt routing can cause severe injuries in the event of an accident or a sudden braking or driving manoeuvre.

- The seat belts only offer best protection when the backrests are in an upright position and the seat belts have been fastened properly.
- The seat belt itself or a loose seat belt can cause serious injuries if the seat belt shifts from harder body parts in the direction of softer body parts such as the stomach.
- Route the seat belt so that it lies flat and snugly on your upper body.
- The lap part of the seat belt must lie across the pelvis and never across the stomach. Route the seat belt so that it lies flat and snugly on your pelvis. Pull the belt a little again to tighten it if necessary.
- For pregnant women, the seat belt must be positioned evenly over the chest and as low as possible over the pelvis during the entire course of the pregnancy. It must lie flat so that no pressure is exerted on the lower body.
- Do not twist the seat belt when it is fastened.
- Never hold the seat belt away from your body with your hand.
- Do not route the belt over hard or fragile objects, such as glasses, pens or keys.
- Never change the belt routing by means of belt clips, retaining eyes or similar.

**i** If a person's physical build prevents them from routing the seat belt properly, contact a correspondingly qualified workshop to find out about any special modifications so that the seat belts and airbags can provide the optimum level of protection. Volkswagen recommends using a Volkswagen dealership.

## Seat belt height adjuster

**!** Please refer to **!** at the start of the chapter on page 44.



**Fig. 37** Next to the front seats: belt height adjuster.

The seat belt height adjusters for the front seats can be used to adjust the position of the seat belt on the shoulder so that it can be fastened properly:

1. Press the button of the seat belt height adjuster together in the direction of the arrows and hold → Fig. 37.
2. Push the seat belt height adjuster up or down so that the seat belt is routed over the middle of the shoulder → page 46.
3. Release the button of the seat belt height adjuster.
4. Pull sharply on the seat belt to check that the seat belt height adjuster is engaged securely.

### **! WARNING**

Never adjust the seat belt height when the vehicle is in motion.

## Belt retractor, belt tensioner, belt tension limiter

**!** Please refer to **!** at the start of the chapter on page 44.

The seat belts in the vehicle are part of the vehicle safety concept → page 50. The vehicle safety concept has the following important functions:

### **Belt retractor**

The seat belts on the driver seat and front passenger seat, as well as those on the outer rear seats (and on

the middle rear seat, depending on the level of vehicle equipment), are fitted with an automatic belt retractor at the shoulder part of the seat belt. Full freedom of movement is ensured when the shoulder belt is pulled slowly or when the vehicle is travelling at normal speeds. However, if the belt is pulled out quickly or during sudden braking, during travel in mountains or bends and during acceleration, the belt retractor blocks the seat belt.

Fastened seat belts on the front seats may be tensioned automatically by the proactive occupant protection system in critical situations, for example during an emergency stop or in the event of oversteering or understeering. Both seat belts are slackened again if the accident does not happen, or when the critical situation has passed. The proactive occupant protection system is ready to be triggered again → page 49.

### Belt tensioner

The seat belts for the front seat vehicle occupants, and, depending on the vehicle equipment, those on the outer rear seats, are equipped with belt tensioners.

The belt tensioners are activated by sensors and tighten the seat belts during severe frontal, side and rear collisions and also possibly vehicle rollovers. Any slack in the seat belt is tightened. This can reduce the forward movement of the vehicle occupants and their movement in the direction of the impact. The belt tensioner works together with the airbag system. If the vehicle rolls over, the belt tensioner will not be activated if the curtain airbags are not triggered.

A fine dust may be produced when the airbags are triggered. This is quite normal and does not mean that there is a fire in the vehicle.

### WARNING

The protective function of the belt tensioners permits only one activation of the belt tensioners. The system must be replaced if the belt tensioners have been triggered.

- Belt tensioners that have been triggered, and any affected system parts, must be replaced immediately with new parts that are approved by Volkswagen for the vehicle.
- Have repairs and modifications to your vehicle carried out only by a correspondingly qualified workshop. Correspondingly qualified workshops have the necessary tools, diagnostic equipment, repair information and qualified personnel. Volkswagen recommends using a Volkswagen dealership.

- Never install recycled belt tensioner components or components that have been taken from end-of-life vehicles in your vehicle.
- Never modify any components of the belt tensioners.

### Reversible belt tensioning (proactive occupant protection system)

Reversible belt tensioning may trigger in certain driving situations → page 49. Examples include:

- Strong braking.
- Oversteer or understeer.
- Minor collisions.



The reversible belt tensioners may remain continuously tensioned after certain driving situations. In this case, the seat belts must be manually unfastened when the vehicle is stationary and then fastened correctly again in order to release the belt tensioning.



### Belt tension limiter

The belt tension limiter reduces the pressure exerted by the seat belt on the body during an accident.



Observe all safety requirements when the vehicle or components of the system are scrapped. These requirements are known to the correspondingly qualified workshops → page 48. Volkswagen recommends using a Volkswagen dealership. ◀

## Service and disposal of belt tensioners

 Please refer to  at the start of the chapter on page 44.

Seat belts may become damaged during work on the belt tensioners or while removing or installing vehicle parts in conjunction with other repair work. This damage will not always be noticeable. The consequence may be that the belt tensioners could function incorrectly, or not function at all, in the event of an accident.

Regulations must be observed to ensure that the effectiveness of the belt tensioner is not reduced and that removed parts do not cause any injuries or environmental pollution. These requirements are known to the correspondingly qualified workshops. Volkswagen recommends using a Volkswagen dealership.

### WARNING

The risk of severe or fatal injuries may be increased if the seat belts, automatic belt retractors

and belt tensioners are not used correctly, or if they are repaired by a non-professional. As a result, the belt tensioners may not be triggered when they should, or they may be triggered unexpectedly.

- Never carry out any repairs, adjustments or removal and refitting of parts in the belt tensioners or seat belts by yourself, and have such work carried out only by a correspondingly qualified workshop → page 361. Volkswagen recommends using a Volkswagen dealership.
- Seat belts, belt tensioners and automatic belt retractors cannot be repaired. They must be replaced.

 The airbag modules and belt tensioners may contain perchlorate. Observe the legal requirements for disposal.

## Proactive occupant protection system

### Introduction to the topic

The proactive occupant protection system is an assistance system that initiates action to protect vehicle occupants in dangerous situations. However, the system cannot prevent a collision.

#### Speed range

The basic function of the proactive occupant protection system is available when driving forwards at speeds from approx. 30 km/h (19 mph).



### WARNING

The intelligent proactive occupant protection system cannot overcome the laws of physics, and functions only within the limits of the system. Never let the extra convenience afforded by the proactive occupant protection system tempt you into taking any risks when driving. The system cannot prevent a collision. The system is not a substitute for the full concentration of the driver.

- Adapt your speed and distance from the vehicles ahead to suit visibility, weather, road and traffic conditions.
- The system cannot detect objects in all situations.
- The proactive occupant protection system does not react to animals or poorly visible objects.

- Reflective objects such as safety barriers, tunnel entrances, heavy rain and ice can impair the performance of the proactive occupant protection system and thus prevent it from detecting a collision risk.
- The system may be falsely triggered.

## Functions of the proactive occupant protection system

 Please refer to  at the start of the chapter on page 49.

### Basic functions

The following functions may be triggered individually or together in critical driving situations, e.g. in the event of emergency braking, understeer and oversteer or minor collisions:

- Reversible belt tensioning of the fastened driver and front passenger seat belts.
- Automatic closing of the glass roof and side windows down to a gap, depending on the vehicle equipment.
- Activation of the hazard warning lights.

The belts may be tensioned individually or together depending on the respective critical driving situations.

### Additional functions for vehicles with Autonomous Emergency Braking (Front Assist)

For vehicles with Autonomous Emergency Braking (Front Assist), the system limits also include calculation of the probability of a rear-end collision with the vehicle in front. If the system detects that a rear-end collision is likely, or initiates severe braking, it can trigger the proactive occupant protection system.

### Additional functions for vehicles with lane change system (Side Assist)

In vehicles fitted with a lane change system (Side Assist), the probability of a collision with the vehicle following behind is also calculated within the system limits. The system can trigger the proactive occupant protection system if it detects a probable collision with the vehicle ahead. If the risk of a collision is detected, the hazard warning lights can also be activated with a rapid hazard warning flashing frequency in addition to the basic function of the proactive occupant protection system.

### Additional functions for vehicles with Emergency Assist

The proactive occupant protection system may be triggered in vehicles with Emergency Assist if no driver activity is detected.

Depending on the activation level, the following functions are triggered:

- Reversible belt tensioning of the driver's fastened seat belt for a brief or extended period of time.
- Automatic closing of the glass roof and side windows down to a gap, depending on the vehicle equipment.

### Setting in driving profile selection

In vehicles with driving profile selection, the proactive occupant protection system is adapted to the special vehicle setup of the respective driving profile.

### Settings in the Infotainment system

Depending on the vehicle equipment, settings for the proactive occupant protection system with the full range of functions can be made in the vehicle settings in the Infotainment system.

The proactive occupant protection system will be re-activated every time the ignition is switched on.

It may not be possible to operate the setting function if the proactive occupant protection system has already been adapted to the specific vehicle setup. <

## Limits of the proactive occupant protection system

📖 Please refer to ⚠️ at the start of the chapter on page 49.

The availability of the proactive occupant protection system depends on country-specific legal regulations and the vehicle equipment.

The proactive occupant protection system will not be available, or will only be available to a limited extent, in the following situations:

- Malfunction in the ESC, reversible belt tensioners → page 44 or airbag control unit → page 50.
- ASR is deactivated or ESC is restricted → page 207.
- *Offroad* driving profile set.
- Autonomous Emergency Braking (Front Assist) is restricted or has a system fault.
- System fault or restriction of the lane change system (Side Assist).

- Emergency Assist is restricted or has a system fault.
- Reverse gear is engaged. <

## Troubleshooting

📖 Please refer to ⚠️ at the start of the chapter on page 49.

**A message is shown for a short time on the instrument cluster display.**

- The proactive occupant protection system functions are restricted or the system is not available. Switch off and restart the engine.
- If the fault persists, go to a correspondingly qualified workshop and have the proactive occupant protection system checked. Volkswagen recommends using a Volkswagen dealership.

📘 Depending on the malfunction, additional information may be displayed in the vehicle status → page 37. <

## Airbag system

### 📖 Introduction to the topic

The vehicle is equipped with a front airbag for the driver and front passenger. The front airbags can provide front seat occupants with additional chest and head protection if the seat, seat belts, head restraints and, in the case of the driver, steering wheel are adjusted and used correctly. Airbags are meant only for additional protection. The airbags are not a substitute for seat belts. Seat belts must always be worn, even when the front seats are equipped with front airbags.

### ⚠️ WARNING

Never rely solely on the airbag system for your protection.

- Even if an airbag is triggered, it only offers auxiliary protection.
- The airbag system offers the best level of protection, and reduces the risk of injury, when seat belts are properly worn → page 44.
- Before every trip, each vehicle occupant must adopt the correct sitting position, correctly fasten the seat belt belonging to their seat and keep it fastened properly throughout the trip.

This applies to all vehicle occupants and also in urban traffic.

### WARNING

The risk of injury increases if there are any objects between the vehicle occupants and the deployment area of the airbag when it is triggered. This will alter the deployment zone of the airbag, or the objects will be flung against the body.

- Never hold any objects in your hand or on your lap while the vehicle is in motion.
- Never transport any objects on the front passenger seat. The objects could enter the deployment zone of the airbag during sudden braking or driving manoeuvres and then be flung dangerously through the vehicle interior if the airbag is activated.
- There must be no other persons, animals or objects between the vehicle occupants sitting on the front seats and rear outer seats and the deployment zones of the airbags. Ensure that children and adults travelling in the vehicle also keep to this rule.

### WARNING

The airbag system can only be triggered once. The system will have to be replaced if the airbags have been triggered.

- Airbags that have been triggered, and any affected system parts, must be replaced immediately with new parts that are approved by Volkswagen for the vehicle.
- Have repairs and modifications to your vehicle carried out only by a correspondingly qualified workshop. Correspondingly qualified workshops have the necessary tools, diagnostic equipment, repair information and qualified personnel. Volkswagen recommends using a Volkswagen dealership.
- Never install recycled airbag components or components that have been taken from end-of-life vehicles in your vehicle.
- Never alter any components of the airbag system.

### WARNING

Fine dust particles or steam may be released when the airbags are triggered. This is normal and does not mean that there is a fire in the vehicle.

- The fine dust can cause irritation to the skin and eye membranes and cause breathing difficulties, particularly for people suffering from asthma or people who have (had) other respiratory problems. To help reduce breathing difficulties,

get out of the vehicle or open the windows or doors for more fresh air.



- If you come into contact with the dust, you should wash your hands and face with a mild soap and water before eating.
- Do not let the dust get into your eyes or into open wounds.
- Rinse out your eyes with water if dust has got into them.

### WARNING

Cleaning agents that contain solvents cause the surface of the airbag units to become porous. In an accident that triggers the airbag, loose plastic parts can cause serious injury.

- Never clean the dash panel or the airbag covers with cleaning agents that contain solvents.

## Type of front passenger front airbag system

 Please refer to  at the start of the chapter on page 50.

Volkswagen offers two different front passenger front airbag systems.

Depending on the vehicle equipment, an **airbag system** or an **airbag system with front passenger front airbag deactivation** may be installed.

### Airbag system

The front passenger front airbag can be deactivated only by a correspondingly qualified workshop. Volkswagen recommends using a Volkswagen dealership.



Characteristics of the airbag system:

- Front passenger front airbag in the dash panel.
- Yellow indicator lamp  in the instrument cluster display.

### Airbag system with front passenger front airbag deactivation



The front passenger front airbag can be deactivated manually by means of a key-operated switch → page 55.

Characteristics of the airbag system with front passenger front airbag deactivation:

- Front passenger front airbag in the dash panel.
- Yellow indicator lamp  in the instrument cluster display.
- Yellow indicator lamp **PASSENGER AIR BAG OFF**  in the centre console.

- Yellow indicator lamp PASSENGER AIR BAG **ON**  in the centre console.
- Key-operated switch in the side of the dash panel on the passenger side, which is visible only when the front passenger door is open.

## Indicator lamp

 Please refer to  at the start of the chapter on page 50.

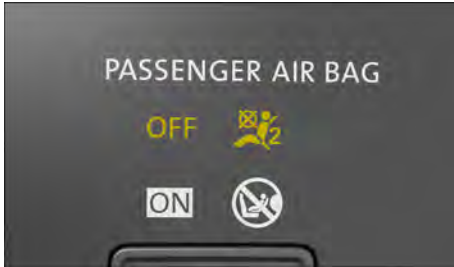

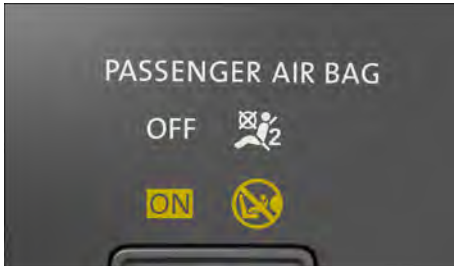

**Fig. 38** In the centre console: indicator lamp for disabled front passenger front airbag.





**Fig. 39** In the centre console: indicator lamp for activated front passenger front airbag.

 The yellow indicator lamp in the instrument cluster display lights up briefly as a functional check when the ignition is switched on and goes out after a few seconds.

**OFF**  Front passenger front airbag switched off. The yellow indicator lamp in the centre console lights up continuously → [Fig. 38](#).

**ON**  Front passenger front airbag switched on. The yellow indicator lamp in the centre console will go out automatically approximately 60 seconds after the ignition is switched on or after the front passen-

ger front airbag is switched on using the key-operated switch → [Fig. 39](#).



There may be a fault in the airbag system if the front passenger front airbag is **switched off** and the yellow PASSENGER AIR BAG indicator lamp **OFF**  in the centre console **does not light up continuously** or lights up together with the yellow  indicator lamp in the instrument cluster display → .

## WARNING

If there is a fault in the airbag system, the airbag may not trigger correctly, may not trigger at all or may trigger unexpectedly. This can cause severe or fatal injuries.

- Have the airbag system checked immediately by a correspondingly qualified workshop. Volkswagen recommends using a Volkswagen dealership.
- Never fit a child seat on the front passenger seat. Remove any child seat present! The front passenger front airbag may trigger during an accident in spite of the fault.

## Troubleshooting

 Please refer to  at the start of the chapter on page 50.

### Fault in airbag or belt tensioner system

The yellow indicator lamp lights up continuously. In addition, a message may be displayed in the instrument cluster.

A malfunction has been detected in at least one airbag or belt tensioner.

1. Go to a correspondingly qualified workshop and have the airbag and belt tensioner system checked. Volkswagen recommends using a Volkswagen dealership.

### Airbag system or belt tensioner system deactivated with diagnostic tool

The yellow indicator lamp lights up for around 4 seconds when the ignition is switched on and then flashes for around 12 seconds. In addition, a message may be displayed in the instrument cluster.

At least one airbag or belt tensioner was deactivated with a diagnostic tool.

1. Go to a correspondingly qualified workshop and have a check carried out to establish whether the airbag or belt tensioner system must remain switched off. Volkswagen recommends using a Volkswagen dealership.

## **OFF** Front passenger front airbag switched off

The yellow indicator lamp for the deactivated front passenger front airbag lights up continuously.

The front passenger front airbag has been switched off.

1. Check whether the front passenger front airbag must remain switched off, e.g. when using a child seat on the front passenger seat.



## **ON** Front passenger front airbag switched on

The yellow indicator lamp for the activated front passenger front airbag lights up for around 60 seconds after the ignition has been switched on or after switching on the front passenger front airbag with the key-operated switch.

The front passenger front airbag has been switched on.

1. Check whether the front passenger front airbag must remain switched on. 

## **Description and function of the airbags**

 Please refer to  at the start of the chapter on page 50.

The airbags can protect vehicle occupants during frontal and side collisions by reducing their movement in the direction of the collision.

When an airbag is triggered, it is inflated by a gas generator. This causes the airbag covers to break, and the airbags inflate forcefully to cover their deployment zones within milliseconds. Once a vehicle occupant wearing a seat belt starts to sink into the inflated airbag, the gas inside the airbag starts to escape to cushion the occupant and slow down their movement. This can reduce the risk of severe and fatal injuries. A triggered airbag will not always prevent other injuries from occurring, such as swelling, bruising, burning and grazing. The deployment of the airbag can also produce frictional heat.

Airbags provide no protection for the arms or lower body. Exception: in vehicles with a knee airbag, the knee area of the driver will be protected.

The most important factors for triggering the airbag are the type of accident, the angle of impact, the vehicle speed and the type of object with which the vehicle collides. Therefore, visible damage to the vehicle does not always mean that the airbag should have been triggered.



Whether or not the airbag triggers is determined by the vehicle deceleration rate caused by the collision and registered by the electronic control unit. If this rate is below the reference value programmed into the control unit, the airbags will not be triggered, even though the vehicle may be badly damaged as a result of the collision. Vehicle damage, repair costs or even the lack of vehicle damage in an accident do not necessarily give an indication of whether an airbag should inflate or not. It is not possible to define a range of vehicle speeds and reference values, since the circumstances will vary considerably between one collision and another. It is therefore impossible to cover every possible kind and angle of impact that would trigger the airbags. Important factors in the triggering of the airbag include the nature (hard or soft) of the object that the vehicle hits, the angle of impact, and the vehicle speed.



Airbags only serve as a supplement to the three-point automatic seat belt in some accident situations when the vehicle deceleration is sufficient to trigger the airbags. Airbags can only be triggered once and only in certain situations. The seat belts are always there to provide protection in situations where airbags are not normally triggered or where they have already been triggered, for example if the vehicle collides with another vehicle after the first collision or is hit by another vehicle.

The airbag system is part of the vehicle's overall passive safety concept. The airbag system can only work effectively when the occupants are wearing their seat belts correctly and have assumed a proper sitting position  → page 43, → page 44.

### **Components of the vehicle safety concept**

The following vehicle safety equipment makes up the vehicle's safety concept to reduce the risk of severe and fatal injuries. Some of this equipment may not be fitted in your particular vehicle. It may not be available at all in some countries.



- Optimised seat belts for all seats.
- Belt tension limiter for the driver, front passenger and, if applicable, for the rear outer seats.
- Belt tensioner for the driver, front passenger and, if applicable, for the rear outer seats.
- Belt height adjuster for the front seats.
- Red warning lamp  and, where applicable, belt status display.
- Front airbags for driver and front passenger.
- Side airbags for the driver, front passenger and, if applicable, for the rear outer seats.
- Curtain airbags on the left and right.
- If applicable, knee airbag for the driver.
- Yellow airbag indicator lamp .

- Yellow indicator lamp PASSENGER AIR BAG OFF  in the centre console.
- Yellow indicator lamp PASSENGER AIR BAG ON  in the centre console.
- Control units and sensors.
- Safety-optimised and height-adjustable head restraints.
- Adjustable steering column.
- If applicable, anchor points for child seats on the rear outer seats and on the front passenger seat.
- If fitted, mounting points for the top tether for child seats.

#### Situations when the front, knee, side and curtain airbags will not be triggered:

- When the ignition is switched off during a collision.
- If the level of deceleration measured by the control unit is too low during a collision at the front of the vehicle.
- During a slight side collision.
- During a rear-end collision.
- When the vehicle rolls over.
- If the impact speed in a collision is lower than the reference value specified in the control unit. 

## Front airbags

 Please refer to  at the start of the chapter on page 50.

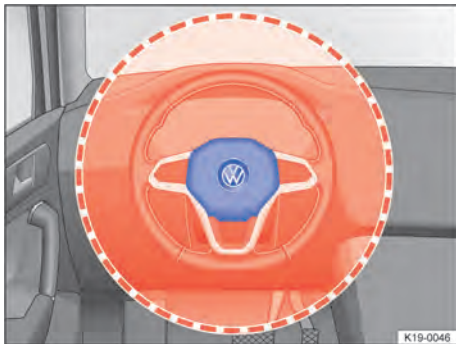

**Fig. 40** Location and deployment zone of the driver front airbag.

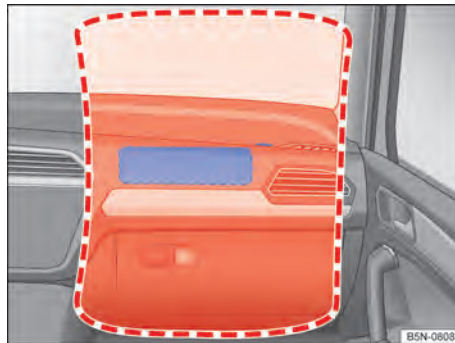

**Fig. 41** Location and deployment zone of the front passenger front airbag.

In conjunction with the seat belts, the front airbag system gives the front occupants additional protection for the head and chest in the event of a severe frontal collision. The curtain airbags on both sides are also triggered in the event of certain types of frontal collision.

Always keep as far away from the front airbag as possible → page 43. This allows the front airbags to inflate fully when triggered, thus providing maximum protection.

The front airbag for the driver is located in the steering wheel → Fig. 40 and the front airbag for the front passenger is located in the dash panel → Fig. 41. The airbag locations are identified by the text "AIRBAG".

The areas inside the red lines are covered by the front airbags when deployed (deployment zone). You must never leave or attach any objects in these areas → . Any factory-fitted accessories will not be struck if the driver and front passenger front airbags are deployed.

### DANGER

Once triggered, the airbag inflates in fractions of a second at very high speed.

- Always leave the deployment zones of the front airbags clear.
- Never attach any objects, such as drink or telephone holders, to the covers of the airbags or anywhere in the airbag deployment zone.
- There must be no other people, animals or objects between the occupants of the front seats and the airbag deployment zones. Ensure that children and other passengers in the vehicle also keep to this rule.



- Do not attach any objects, e.g. mobile navigation devices, to the windscreen above the front airbag on the front passenger side.
- Do not stick anything on or cover the steering wheel airbag unit and the surface of the dash panel in the deployment zone of the front passenger front airbag or modify these components in any way.

### **⚠ WARNING**

The front airbags are deployed in front of the steering wheel → Fig. 40 and dash panel → Fig. 41.

- Always hold the steering wheel with both hands at the sides on the rim in the nine o'clock and three o'clock positions while driving.
- Adjust the driver seat so that there is at least 25 cm (approximately 10 inches) between the driver's rib cage and the hub of the steering wheel. If your build makes it impossible to fulfil this requirement, then you must contact a correspondingly qualified workshop. Volkswagen recommends using a Volkswagen dealership.
- Adjust the front passenger seat so that the distance between the passenger and the dash panel is as large as possible.

## Switching the front passenger front airbag on and off

📖 Please refer to ⚠ at the start of the chapter on page 50.



**Fig. 42** In the dash panel on the front passenger side: key-operated switch for deactivating and activating the front airbag on the front passenger side

**The front passenger front airbag must be deactivated if you fit a rear-facing child seat on the front passenger seat.**

Observe the country-specific specifications for use of child seats on the front passenger seat → page 60.

The option to deactivate the front passenger front airbag is not available in all countries → page 51.

### Switch on the front passenger front airbag

1. Switch off the ignition.
2. Open the door on the front passenger side.
3. Fold the key bit of the vehicle key all the way out.  
**Or:** remove the manual key from the vehicle key.
4. Insert the key bit into the key-operated switch until you feel the second point of resistance → Fig. 42.

The key bit is not fully inserted when doing this → ⚠.

5. Turn the vehicle key or manual key without using force to the position **ON**.
6. Remove the vehicle key from the key-operated switch and fold away the key bit → ⚠.

**Or:** remove the manual key from the key-operated switch and insert it back into the vehicle key → ⚠.

The yellow PASSENGER AIR BAG indicator lamp **ON** lights up and goes out after approximately 60 seconds → page 52.

7. Close the door on the front passenger side.
8. Check that the yellow PASSENGER AIR BAG **OFF** indicator lamp does not light up when the ignition is switched on → page 52.

### Switch off the front passenger front airbag

1. Switch off the ignition.
2. Open the door on the front passenger side.
3. Fold the key bit of the vehicle key all the way out.  
**Or:** remove the manual key from the vehicle key.
4. Insert the key bit into the key-operated switch until you feel the second point of resistance → Fig. 42.

The key bit is not fully inserted when doing this → ⚠.

5. Turn the vehicle key or manual key without using force to the position **OFF**.
6. Remove the vehicle key from the key-operated switch and fold away the key bit → ⚠.



**Or:** remove the manual key from the key-operated switch and insert it back into the vehicle key → ⚠.

7. Close the door on the front passenger side.

The yellow PASSENGER AIR BAG OFF  indicator lamp lights up continuously when the ignition is switched on → page 52.

#### Confirmation that the front passenger front airbag has been deactivated

A deactivated front passenger front airbag is indicated only by the PASSENGER AIR BAG OFF  indicator lamp lighting up yellow continuously → page 52.

If the yellow PASSENGER AIR BAG OFF  indicator lamp does not light up continuously or lights up together with the yellow  indicator lamp in the instrument cluster display, no child restraint system must be fitted on the front passenger seat for safety reasons. The front passenger front airbag may trigger during an accident.

#### DANGER

Observe the important safety instructions for the front passenger front airbag → page 60.

#### DANGER

The front passenger front airbag should only be switched off in exceptional circumstances.

- To prevent damage to the airbag system, switch the front passenger front airbag on and off only when the ignition is switched off.
- It is the driver's responsibility to ensure that the key-operated switch is set to the correct position.
- Switch the front passenger front airbag off only if, in exceptional circumstances, a rear-facing child seat is secured on the front passenger seat.
- Switch the front passenger front airbag back on again as soon as the rear-facing child seat on the front passenger seat is no longer being used.

#### WARNING

Do not leave the vehicle key or manual key inserted in the key-operated switch while the vehicle is in motion.

- Vibrations in the vehicle could cause the vehicle key or manual key to turn in the key-operated switch, which could then activate the front passenger front airbag.
- The front passenger front airbag could then accidentally inflate, leading to serious or fatal injuries.



#### NOTICE

If the key bit is not inserted far enough, the key switch could be damaged when the key is turned.

#### NOTICE

Do not leave the vehicle key or manual key in the key-operated switch, as this could result in damage to the door trim, dash panel, key-operated switch and vehicle key or manual key when the front passenger door is closed. 

### Side airbags

 Please refer to  at the start of the chapter on page 50.

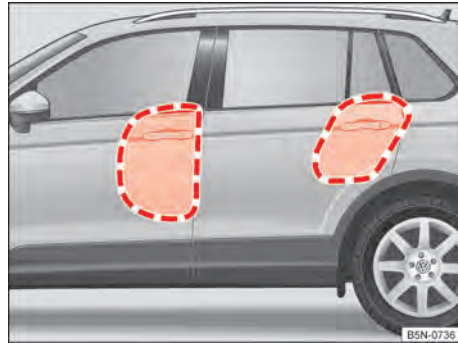

**Fig. 43** In the interior on the left-hand side of the vehicle: side airbag deployment zones.



**Fig. 44** On the side of the front seat: location and deployment zone of the side airbag.

Side airbags are fitted for the front seats and rear outer seats → Fig. 43.

The side airbags for the front seats are located in the outer backrest padding of the driver seat and front passenger seat → Fig. 44.

If fitted, the side airbags for the rear outer seats are each located between the door entry and the individual rear seat backrests.

The locations of the side airbags are indicated by the "AIRBAG" label.

The areas outlined in red are inside the deployment area of the side airbags → Fig. 43 and → Fig. 44. You must never leave or attach any objects in these areas → ⚠.

In the event of a side collision, the side airbags will be deployed on the side of the vehicle which is impacted, thus reducing the risk of injury to the areas of the occupants' bodies facing the impact. The curtain airbags on both sides are also triggered.

### ⚠ WARNING

Once triggered, the airbag inflates in fractions of a second at very high speed.

- Always leave the deployment zones of the side airbags clear.
- There must be no other people, animals or objects between the occupants of the front seats and the airbag deployment zones. Ensure that children and other passengers in the vehicle also keep to this rule.
- The coat hooks in the vehicle should be used only for lightweight clothing. Do not leave any heavy or sharp objects in the pockets.
- Do not fit any accessories to the doors.
- Do not fit seat covers or protective covers over the seats unless they have been expressly approved for use in the vehicle. Otherwise the side airbag may not be able to inflate once triggered.

### ⚠ WARNING

Incorrect use of the driver and front passenger seat could hinder the proper function of the side airbag and cause serious injury.

- Never remove the front seats from the vehicle or alter any components of these seats.
- If too much pressure is applied to the backrest side bolsters, the side airbags may not be triggered correctly, may not trigger at all, or may trigger accidentally.
- Have any damage to the seat covers or around the seams of the side airbag units repaired immediately by a correspondingly qualified workshop. Volkswagen recommends using a Volkswagen dealership.

## Curtain airbags

📖 Please refer to ⚠ at the start of the chapter on page 50.

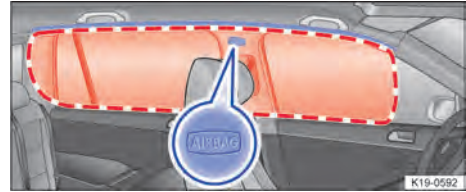

Fig. 45 On the left-hand side of the vehicle: location and deployment zone of the curtain airbag.

Curtain airbags are installed in the vehicle interior above the doors on the driver and front passenger sides → Fig. 45.

The locations of the curtain airbags are indicated by the "AIRBAG" label.

The area in the red frame is covered by the curtain airbag when triggered (deployment zone) → Fig. 45. For this reason, you must never leave or attach any items in this area → ⚠.

The curtain airbags are triggered on both sides in the event of a side collision and certain types of frontal collision.

In a side collision and certain types of frontal collision, the curtain airbags reduce the risk of injury for the vehicle occupants on the front seats and rear outer seats.

### ⚠ WARNING

Once triggered, the airbag inflates in fractions of a second at very high speed.

- Always leave the deployment zones of the curtain airbags clear.
- Never secure any items to the cover or in the deployment zone of the curtain airbag.
- There must be no other persons, animals or objects between the vehicle occupants sitting on the front seats and rear outer seats and the deployment zones of the airbags. Ensure that children and other passengers in the vehicle also keep to this rule.
- The coat hooks in the vehicle should be used only for lightweight clothing. Do not leave any heavy or sharp objects in the pockets.
- Do not fit any accessories to the doors.
- Do not install any sun blinds onto the side windows unless they have been expressly approved for use in your vehicle.

- Only push the sun visors over to the side windows if no items are attached to the visors (e.g. pens or a garage door opener).

## Knee airbag

📖 Please refer to ⚠️ at the start of the chapter on page 50.



Fig. 46 On the driver side: location of the knee airbag.

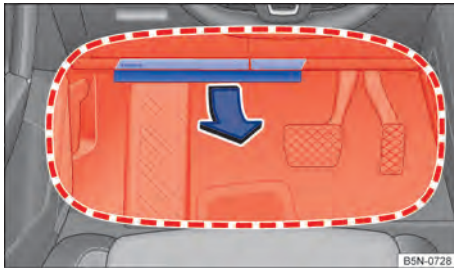

Fig. 47 On the driver side: deployment zone of the knee airbag.

Depending on the vehicle equipment, a knee airbag may be installed on the driver side in the lower part of the dash panel.

The location of the knee airbag is indicated by the "AIRBAG" label → Fig. 46.

The area in the red frame is covered by the knee airbag when triggered (deployment zone) → Fig. 47. For this reason, you must never leave or attach any items in this area → ⚠️.

### ⚠️ WARNING

Once triggered, the airbag inflates in fractions of a second at very high speed.

- Do not use any objects, e.g. key rings, that could interfere with the deployment zone of the knee airbag.

- Never secure any items to the cover or in the deployment zone of the knee airbag.
- The knee airbag is deployed in the area in front of the driver's and front passenger's knees. Move the driver and front passenger seat as far back as possible so there is a distance of at least 10 cm (about 4 inches) between the knees and the location of the knee airbag. If your build makes it impossible to fulfil this requirement, then you must contact a correspondingly qualified workshop. Volkswagen recommends using a Volkswagen dealership.

## Safe transport of children

### 📖 Introduction to the topic

Using child seats can reduce the risk of injury to the child if there is an accident. Always use child seats when driving with children.

Note the following:

- Child seats are classified into groups depending on the size, age and weight of the child for which they are designed.
- Various securing systems are used to secure child seats in the vehicle.

For safety reasons, child seats must always be fitted to the rear seats → page 60.

Volkswagen recommends child seats from the Volkswagen range of accessories. These child seats have been developed and approved for use in Volkswagen vehicles.

For further information on the child seats from the range of accessories, contact a Volkswagen dealership or visit the Volkswagen website.

### ⚠️ WARNING

If children are not secured or are inadequately secured, they are at greater risk of serious or even fatal injury. Please note the following:

- Children who are either under 12 years of age or less than 150 cm (approximately 59 inches) tall must not be carried in the vehicle unless they are secured in a suitable child seat while the vehicle is in motion. Regulations in some countries may differ and must be complied with.
- Always secure children in the vehicle in a suitable child seat. The seat used must be appropriate to the child's height, weight and age.
- Observe the specifications of the child seat manufacturer when installing the child seat in

the vehicle and securing the child in the child seat.

- Never fasten more than one child into one child seat.
- Under no circumstances should children or babies be held in a passenger's or driver's lap while driving.
- Never leave a child unsupervised in a child seat.
- Never allow a child to be carried in a vehicle without being properly secured, and never allow a child to stand up or to kneel on a seat, or to sit incorrectly while the car is in motion. This is particularly important for children carried on the front passenger seat. In an accident, children may sustain serious injuries to themselves and others.
- The child seat can only provide maximum protection if the seat belt is routed correctly around it. Always ensure that the seat belt is routed as specified in the instructions provided by the child seat manufacturer. If the seat belts are not worn correctly this can cause injuries even in a minor accident.
- After an accident, it is vital to replace any child seats that were in use during the accident, as they could have sustained non-visible damage.

### NOTICE

Please observe the notes and information for vehicles with N1 approval → page 372, *Information about vehicles with N1 approval (light commercial vehicle)*.

## Types of child seat

📖 Please refer to ⚠️ and ⓘ at the start of the chapter on page 58.

Only use child seats that have been officially approved and are suitable for the child.

### Standards for child seats

The regulations ECE-R 44 or ECE R 129 apply to child seats in the user countries. Both regulations apply simultaneously. Child seats which have been tested in accordance with these standards carry an orange ECE approval label. This ECE approval label may include the following information on the child seat:

- Weight class.
- Size class.

- Approval category (universal, semi-universal, vehicle-specific or i-Size).
- Approval number.

On child seats that are approved under regulation ECE R 44, the eight-digit approval number on the ECE approval label must begin with 03 or 04. This shows that the seat is admissible for use. Older child seats with an approval number beginning with 01 or 02 are not admissible.

### Child seat weight classes



Fig. 48 Example illustrations of child seats.

Class	Child's weight
Group 0	up to 10 kg
Group 0+	up to 13 kg
Group 1	9 to 18 kg
Group 2	15 to 25 kg
Group 3	22 to 36 kg

- **Weight class 0/0+:** group 0/0+ or 0/1 rear-facing infant carriers → Fig. 48 are the best option for the period from birth to about 18 months.
- **Weight class 1:** group 1 (up to about 4 years old) and group 1/2 (up to about 7 years old) with an integral belt system are the best for children over the relevant weight limit.
- **Weight classes 2/3:** groups 2 and 3 include child seats with a backrest, and booster seats with no backrest. Child seats with a backrest have integrated seat routing and side padding, and so provide better protection than booster seats with no backrest. Volkswagen therefore recommends the use of child seats with a backrest. Group 2 child seats are for children up to the age of about 7, group 3 child seats for children more than around 7 years old.

When using a Group 2 child seat, use the fourth anchorage point of the child seat, if available, for the seat belt. Please observe the instructions for use of the child seat.

Not every child will fit in the child seat specified for their weight group. Likewise, not every seat will fit

in every vehicle. Therefore it is vital to check that the child fits properly in their child seat and that the child seat can be securely fastened in the vehicle.

### Child seat approval categories

Child seats can be classified as "universal", "semi-universal" "or vehicle-specific" (all in accordance with regulation ECE R 44) or "i-Size" (in accordance with regulation ECE R 129).

- **Universal:** child seats with "universal" approval are approved for use in all vehicles. No type list is required. ISOFIX child seats with universal approval must be additionally secured using a strap over the top of the vehicle seat (top tether).
- **Semi-universal:** "semi-universal" approval requires other safety devices for attaching the seat (that require additional testing) in addition to the standard requirements for universal approval. Child seats with "semi-universal" approval come with a type list. The seats should only be used in vehicles that are included on this list.
- **Vehicle-specific:** child seats with vehicle specific approval must have undergone dynamic testing in each model of vehicle for which it is approved. Child seats with "vehicle-specific" approval also come with a type list.
- **i-Size:** child seats classified as "i-Size" must conform to the installation and safety requirements prescribed in regulation ECE R 129. Contact the child seat manufacturer to find out whether child seats are approved for this vehicle, and if so which ones, in accordance with i-Size.

- Whenever possible, fit the child seat on the rear bench seat behind the front passenger seat so that children can exit the vehicle on the kerb side.
- Set the seat belt height so that the seat belt routing follows a natural line and is adjusted to the child seat without turning back on itself. For rear-facing child seats, use the lowest position of the belt height adjuster.
- Deactivate the front passenger front airbag if fitting a rear-facing child seat on the front passenger seat.
- When fitting on the front passenger seat, push the front passenger seat back fully and adjust the seat to the highest position. Adjust the backrest to an upright position → page 91.
- Always ensure that there is enough space around the child seat. If necessary, adjust the position of the seat in front. When doing so, ensure that the driver or front passenger can still maintain a correct sitting position → page 43.
- The backrest of the child seat must lay as flat as possible against the vehicle seat backrest. If required, adjust the seat backrest angle so that the child seat lies flush against the backrest. Once it has been installed, if the child seat is touching the head restraint and therefore cannot be positioned flush against the backrest, push the head restraint all the way up, or remove and stow safely in the vehicle → page 90.

## Installing and using child seats

📖 Please refer to ⚠️ and ⓘ at the start of the chapter on page 58.

### Country-specific regulations

The standards and regulations governing the use of child seats and child seat securing mechanisms differ from country to country. Not all countries allow you to transport children on the front passenger seat. Regulations and legal requirements take precedence over the information given in this owner's manual.

### Information on fitting a child seat

Observe the following general information when fitting a child seat. This information is relevant whatever child seat securing system is being used.

- Read and follow the instructions provided by the child seat manufacturer → ⚠️.

### Airbag sticker



Fig. 49 Illustration: airbag label on the sun visor.



**Fig. 50** Illustration: airbag label on the B-pillar.

The vehicle may be provided with stickers giving important information about the front passenger front airbag. The information on these stickers may vary from country to country. The stickers may be found:

- On the driver sun visor and in some cases on the front passenger sun visor → Fig. 49.
- On the B-pillar on the front passenger side → Fig. 50.

It is essential to observe the warning information shown on these stickers before installing a rear-facing child seat → ⚠.

#### Risks involved in carrying children on the front passenger seat

If you are using a **rear-facing child seat**, the front passenger front airbag can cause critical or potentially fatal injuries when it inflates → ⚠.

Rear-facing child seats may be used on the front passenger seat only if the front passenger front airbag has been deactivated → page 50. A deactivated front passenger front airbag is indicated by means of the continuously lit PASSENGER AIR BAG indicator lamp **OFF** in the driver's field of vision → page 52.

It is not possible to deactivate the front passenger front airbag in all countries → page 51.

If using a **front-facing child seat**, do not deactivate the front passenger front airbag. When fitting the child seat, ensure that it is as far away as possible from the front passenger front airbag. The front passenger front airbag can cause severe injuries when it inflates → ⚠.

Some child seats are not suitable for use on the front passenger seat. The child seat must be specially authorised by the manufacturer for use on the front passenger seat in vehicles with front and side airbags. Volkswagen dealerships keep an up-to-date list of authorised child seats.

#### **⚠ DANGER**

Observe the important safety instructions for the front passenger front airbag → page 55.

#### **⚠ DANGER**

If you use a rear-facing child seat on the front passenger seat, the child in it is at increased risk of sustaining serious or life-threatening injuries or being killed in the event of an accident.

- Never secure a rear-facing child seat on the front passenger seat if the front passenger front airbag is activated.
- Deactivate the front passenger front airbag. If the front passenger front airbag cannot be deactivated, you must not use rear-facing child seats.
- Move the front passenger seat as far back and as high as it can be adjusted to create the largest possible distance between the child seat and the front passenger front airbag.
- Move the backrest to the upright position.
- Set the seat belt height so that the seat belt routing follows a natural path adapted to the child seat without excessive deviations. For rear-facing child seats, use the lowest position of the seat belt height adjuster.
- Only use child seats that have been approved by the child seat manufacturer for use on a front passenger seat with front and side airbags.

#### **⚠ WARNING**

Child seats present a risk of injury if incorrectly installed.

- Always read and follow the installation instructions and warning information provided by the child seat manufacturer.

#### **⚠ WARNING**

Using a front-facing child seat on the front passenger seat presents a risk of injury.

- Move the front passenger seat as far back and as high as it can be adjusted to create the largest possible distance between the child seat and the front passenger front airbag.
- Move the backrest to the upright position.
- Set the seat belt height so that the seat belt routing follows a natural path adapted to the child seat without excessive deviations. For rear-facing child seats, use the lowest position of the seat belt height adjuster.

- Only use child seats that have been approved by the child seat manufacturer for use on a front passenger seat with front and side airbags.

### ⚠ WARNING

To avoid injuries caused by inflation of a head airbag or side airbag:

- Ensure that no children are seated within the airbag deployment zones → page 50.
- Do not place any objects in the side airbag deployment zones.

## Securing systems

📖 Please refer to ⚠ and ⓘ at the start of the chapter on page 58.

Different countries use different securing systems for safely fitting child seats in the vehicle.

### Overview of securing systems

- **ISOFIX:** ISOFIX is a standardised securing system for fitting child seats in the vehicle quickly and safely. The ISOFIX attachment system creates a rigid connection between the child seat and the car body.

The seat has two rigid attachment arms. The attachment arms click into ISOFIX attachment points at the bottom of the backrest on the outer rear seats → page 62. Top tether or a support bracket may sometimes be used in addition to the ISOFIX anchor points described above.

- **Three-point automatic seat belt.** It is better to secure child seats using the ISOFIX system, if availa-

ble, rather than with a three-point automatic seat belt → page 65.

Additional securing points:

- **Top tether:** the strap at the top of the child seat is routed over the rear seat backrest and hooked to an anchor point on the back of the rear seats → page 64. Top tether anchor points are marked with an anchor symbol.
- **Support foot:** some child seats are supported by a support foot resting on the floor of the vehicle. This support foot helps prevent the child seat tipping forward in a crash. Child seats with a support foot can only be used on the front passenger seat and on the outer seats in the second row → ⚠.

### Recommended child seat securing systems

Volkswagen recommends that child seats are secured as follows:

- **Infant carrier or rear-facing child seat:** ISOFIX and support foot.
- **Front-facing child seat:** ISOFIX and top tether and possibly also support foot.

### ⚠ WARNING

Incorrect use of the support foot can cause severe or fatal injuries.

- Ensure that the support foot is always correctly and safely installed.

### ⚠ WARNING

Child restraint anchorages are designed to withstand only those loads imposed by correctly fitted child restraints. Under no circumstances are they to be used for adult seatbelts, harnesses, or for attaching other items or equipment to the vehicle.

## Securing a child seat with ISOFIX/i-Size

📖 Please refer to ⚠ and ⓘ at the start of the chapter on page 58.

### Quick guide to ISOFIX and i-Size installation

The identification marking of the ISOFIX or i-Size anchorage points is equipment and country dependent.

The following table shows the installation options for ISOFIX or i-Size child seats at the ISOFIX or i-Size anchorage points of the individual vehicle locations.

Group	Ori-entation of the child seat	Size class / ISOFIX class	Front passen-ger seat	Outer seats on the rear bench seat	Centre seat on the rear bench seat
Group 0: up to 10 kg	Rear fac- ing	E/R1	X	IL-SU	X



Group	Orientation of the child seat	Size class / ISOFIX class	Front passenger seat	Outer seats on the rear bench seat	Centre seat on the rear bench seat
Group 0+: up to 13 kg	Rear facing	E/R1	X	IL-SU	X
		D/R2	X		X
		C/R3	X		X
Group 1: 9 to 18 kg	Rear facing	D/R2	X	IL-SU, IUF	X
		C/R3	X		X
	Forward facing	B/F2	X		X
		B1/F2X	X		X
Group 2: 15 to 25 kg	Forward facing	A/F3	X	IL-SU	X
		-	X		X
Group 3: 22 to 36 kg	Forward facing	-	X	IL-SU	X
		-	X		X
i-Size child restraint system	Rear facing	-/R2	X	i-U	X
	Forward facing	-/B2, F2X	X		X
Booster seat	Forward facing	-/B2, B3	X	i-B	X

- **Size class:** the size class shown corresponds to the permissible weight range of the child using the seat. The size class is indicated on the ECE approval label for child seats with “universal” or “semi-universal” approval. A size class indication is affixed to the child seat.
- **X:** seat not suitable for securing an ISOFIX or i-Size child seat in this group.
- **IL-SU:** seat suitable for installing an ISOFIX child seat with “semi-universal” approval. Refer to the vehicle list supplied by the child seat manufacturer.
- **IUF:** seat suitable for installing an ISOFIX child seat with “universal” approval.
- **i-U:** seat suitable for installing a front-facing or rear-facing i-Size child seat with “universal” approval.
- **i-UF:** seat suitable for installing a front-facing i-Size child seat with “universal” approval.
- **i-B:** seat suitable for installing a forward-facing ISOFIX booster seat of Group 2/3 as well as a forward-facing i-Size child seat for children with a height of 100 – 150 cm (approximately 39 – 59 inches).

#### Installing child seats with ISOFIX/i-Size

The location of the bottom anchor points is indicated by either an ISOFIX or i-Size symbol.



Markings identifying the ISOFIX anchorage points for child seats on the seats of the rear bench seat.



Markings identifying the i-Size anchorage points for child seats on the seats of the rear bench seat.



**Fig. 51** Illustration: fitting a child seat with the attachment arms.

1. Observe the instructions → page 60, *Installing and using child seats*.
2. When using child seats of groups 0 to 1 and i-Size child seats for children up to a height of 105 cm (around 41 inches) on the rear bench seat, push the rear bench seat back as far as possible → page 94.
3. When using child seats of group 2/3 and i-Size child seats for children as from a height of 100 cm (around 39 inches) on the rear bench

seat, push the rear bench seat to a middle position → page 94.

4. Fold down any protective caps that may be fitted on the ISOFIX or i-Size anchor points.
5. Push the attachment arms of the child seat in the direction of the arrow onto the ISOFIX or i-Size anchorages → Fig. 51. The child seat must click and audibly securely into place.

## Securing child seats with the top tether

📖 Please refer to ⚠ and ⓘ at the start of the chapter on page 58.



Fig. 52 On the back of the rear bench seat: anchor rings for the top tether.

ISOFIX child seats with “universal” approval must be secured with an upper strap (top tether) in addition to the ISOFIX anchor points.

Secure the top tether only at the top tether anchor points provided for this purpose. The anchor points for use with the top tether are marked by a symbol and sometimes also with “TOP TETHER”.

### Securing the top tether

1. Observe the instructions → page 60, *Installing and using child seats*.

6. Perform a pull test on both sides of the child seat to make sure that the child seat is properly engaged.

If the child seat is fitted with a support foot, the foot must stand firmly on the floor of the vehicle. ◀

2. Remove the net partition if necessary.
3. Push the head restraint on the vehicle seat all the way up or remove it.
4. Position the child seat in the centre of the seat cushion.
5. Push the attachment arms on the child seat into the ISOFIX anchor points as shown by the arrows → page 62. The child seat must click and audibly securely into place.
6. Adjust the rear seat backrest to fit the backrest on the child seat.
7. Remove the luggage compartment cover if necessary.
8. Guide the top tether strap of the child seat to the rear over the seat and hook it into the corresponding anchor point labelled “Top Tether” → Fig. 52.
9. Stretch the top tether strap so that the child seat is positioned high on the rear seat backrest.

### ⚠ WARNING

Secure the top tether only at the top tether anchor points provided for this purpose. Failure to do this could lead to severe injuries.

- Always secure only one top tether of a child seat to one top tether anchor point.
- Never secure the top tether of a child seat to a fastening ring.

ⓘ Depending on the country and equipment, there may be two or three top tether anchor points in the luggage compartment behind the rear seat backrest. ◀

## Securing a child seat using the seat belt

📖 Please refer to ⚠️ and ⓘ at the start of the chapter on page 58.

If you want to fit a child seat from the “universal” (u) approval category in your vehicle, you must first ensure that it is approved for the seat position in ques-

tion. Relevant information is given on the orange ECE approval label of the child seat. Installation options are shown in the table below.

Group		Child's weight	Front passenger seat		Seats on the rear bench seat
			Front passenger front airbag activated	Front passenger front airbag deactivated	
Group 0		up to 10 kg	x	u	u
Group 0+		up to 13 kg	x	u	u
Group 1	Rear facing	9 to 18 kg	x	u	u
	Forward facing	9 to 18 kg	u	x	u
Group 2		15 to 25 kg	u	x	u
Group 3		22 to 36 kg	u	x	u

u: universal; x: seat not suitable for securing a child seat of this group.

### Securing a child seat using the seat belt

1. Observe the instructions → page 60.
2. When using child seats of groups 0, 0+ or 1 and i-Size child seats for children up to a height of 105 cm (around 41 inches) on the rear bench seat, push the rear bench seat back as far as possible → page 94.
3. When using child seats of group 2/3 and i-Size child seats for children from a height of 100 cm (around 39 inches) on the rear bench seat, push the rear bench seat to a middle position → page 94.
4. Set the seat belt height so that the seat belt routing follows a natural line and is adjusted to

the child seat without turning back on itself. For rear-facing child seats, use the lowest position of the belt height adjuster.

5. Fasten the seat belt and guide it through the child seat as described in the child seat manufacturer's instructions.
6. Ensure that the seat belt is not twisted.
7. Insert the latch plate into the buckle for the appropriate seat and push it down until it audibly engages.

Child seats with the “semi-universal” approval category, which are fitted by means of a seat belt and support foot, must not be installed on the centre seat of the rear bench seat. <

## In an emergency

### Making you and your vehicle safe

Observe any legislation concerning the safety of a broken-down vehicle. For example, many countries stipulate that you have to switch on the hazard warning lights and wear a high-visibility waistcoat → page 66.

#### Checklist

To ensure your own safety and that of your passengers, observe the following points in the specified order → ⚠️:

1. Stop the vehicle at a safe distance away from moving traffic and on a suitable surface. Ob-

serve all the important information on parking → ⚠️, → page 190.

2. Switch on the hazard warning lights → page 14.
3. Ensure that all occupants exit the vehicle and go to a safe place away from moving traffic, e.g. behind the safety barrier. Observe country-specific regulations on high-visibility waistcoats.
4. Place the warning triangle in position to draw the attention of other road users to your vehicle.
5. Observe the safety instructions for working in the engine compartment → page 310.
6. Seek expert assistance if necessary. Volkswagen recommends using the Volkswagen emergency service.

When the hazard warning lights are switched on, for example if you are being towed, you can still indicate a change in direction or lane change by operating the turn signal. The hazard warning lights will be interrupted temporarily.

Comply with the important information on towing → page 305.

**Switch on the hazard warning lights, e.g. in the following situations:**

- When traffic ahead suddenly slows down or you reach the tail end of a traffic jam to warn vehicles behind you.
- When there is an emergency.
- If the vehicle breaks down.
- When tow-starting or towing.

Always follow local regulations for the use of the hazard warning lights.

If the hazard warning lights are not working, you must use an alternative method of drawing attention to the broken-down vehicle. This method must comply with traffic legislation.

**⚠ WARNING**

Any broken-down vehicle poses a high accident risk for the vehicle occupants and other road users.

- Stop the vehicle as soon as possible and when safe to do so.
- Park the car at a safe distance from moving traffic.
- Switch on the hazard warning lights.
- Never leave other persons alone in the vehicle, particularly children or people requiring assistance. This applies in particular when the doors are locked. People locked in the vehicle may be subjected to very high or very low temperatures.

**⚠ WARNING**

Ignoring any of the items on this important safety checklist can lead to accidents and severe injuries.

- Always follow the actions in the checklist and observe the generally valid safety precautions.

**⚠ WARNING**

The components of the exhaust system become very hot. This can cause fires and serious injuries.

- Park the vehicle so that no part of the exhaust system can come into contact with any inflammable material underneath the vehicle, e.g. dry grass or fuel.

**ⓘ NOTICE**

When pushing the vehicle by hand, do not press on the tail light clusters, the rear spoiler or large panels. This could damage the vehicle and the rear spoiler may become detached.

**ⓘ** The 12-volt vehicle battery will discharge if the hazard warning lights are left on over a long period of time – even when the ignition is switched off.

**ⓘ** Depending on the vehicle equipment, the brake lights flash in quick succession if you brake sharply or initiate full braking at a speed of more than 80 km/h (about 50 mph). This provides an especially conspicuous warning for the following traffic. If you then continue to brake, the hazard warning lights will be switched on automatically at speeds under approximately 10 km/h (6 mph). Once the vehicle starts to accelerate, the hazard warning lights will switch off again. <

**Emergency equipment**

**First-aid kit**

Depending on the equipment in the vehicle, the first aid kit may be located in various locations in the luggage compartment:

- In a bag in one of the side stowage compartments on the left or right of the luggage compartment .
- In a foam rubber holder under the luggage compartment floor.

The first-aid kit must comply with legal requirements.

- Observe the expiry dates of the contents.
- After use, renew contents if necessary and stow the first-aid kit safely again.

### Warning triangle



Fig. 53 In the boot lid: holder for the warning triangle.

Depending on the equipment, the warning triangle may be located in the boot lid.

1. With the boot lid open, turn the lock on the holder 90° anticlockwise → Fig. 53.
2. Open the holder and remove the warning triangle.
3. Return the warning triangle to its holder after use and lock it into place.

The warning triangle must comply with legal requirements.

### High-visibility waistcoat

Depending on the vehicle equipment, the high-visibility waistcoat may be located in a stowage compartment in the front door trim or in the glove box → page 10, → page 15.

The high-visibility waistcoat must comply with legal requirements.

### Fire extinguisher

Depending on the vehicle equipment, a fire extinguisher may be located in a holder in the footwell under the front passenger seat.

The fire extinguisher must comply with legal regulations, must always be ready for use and must be checked regularly, see inspection seal on the fire extinguisher.

### WARNING

In the event of a sudden driving or braking manoeuvre or accident, loose objects could be flung through the vehicle and cause severe injuries.



- Always secure the first aid kit, warning triangle and fire extinguisher safely in the holders provided in the vehicle.

- Stow the high-visibility waistcoat in a stowage compartment where it can be easily reached. <

### Information call, breakdown call and Emergency Call Service



Fig. 54 In the roof console: control unit for voice services.





-  Information Call.
-  Breakdown Call.
-  Emergency Call Service.

Depending on the vehicle equipment and country, voice services can be performed by means of the control in the roof console → Fig. 54. If the Emergency Call Service is available in the vehicle's service portfolio, the Emergency Call Service is activated as standard for a limited period of time. The required connection is established by a factory-fitted control unit.

 Observe the other information on We Connect → page 217.

### Indicator lamp for the Emergency Call Service

The control is equipped with an indicator lamp → Fig. 54 (arrow). Depending on the operational status of the Emergency Call Service in the vehicle, the indicator lamp lights up in different colours and light sequences:

-  Indicator lamp does not light up: Emergency Call Service is deactivated or not available.
-  Indicator lamp flashes red after the ignition is switched on: system error. Emergency Call Service is deactivated.
-  Indicator lamp lights up red continuously: system error. Emergency Call Service is restricted or not available.
-  Indicator lamp lights up green: Emergency Call Service is available, system is ready for operation in the vehicle.

 Indicator lamp flashes green: active connection to a voice service.

### Information Call

- The Information Call enables you to call the Volkswagen AG hotline.
- The Information Call function is available only in some sales regions.
- The advisor who takes your call will talk to you in the language with which the vehicle was registered in Car-Net or We Connect.

### Breakdown Call

- The Breakdown Call function allows you to seek professional assistance should your vehicle break down.
- Some vehicle data, e.g. the current location, is transmitted parallel to the voice call.
- The advisor who takes your call will talk to you in the language with which the vehicle was registered in Car-Net or We Connect.

### Emergency Call Service

- The Emergency Call Service enables help to be organised as quickly as possible in dangerous situations.
- When the Emergency Call Service is triggered, a connection to the Volkswagen emergency call centre is established.
- If an emergency call is placed manually, or automatically after an accident where an airbag or the belt tensioners were triggered, data relevant for the emergency call, e.g. the current vehicle location, will be transmitted automatically → page 365.
- The advisor who takes your call will talk to you in the language set up in the vehicle's Infotainment system. English is used if this language is not available at the location of the emergency.
- Additional factory-fitted components are installed in order to ensure that the function is still possible even after a serious accident, e.g. emergency call microphone, emergency loudspeaker and an integrated battery that is independent of the vehicle electrical system.
- The Emergency Call Service can be permanently deactivated by a correspondingly qualified workshop. Volkswagen recommends using a Volkswagen dealership.
- If the legally required eCall Emergency System is present in the vehicle, the Emergency Call Service can be deactivated in the Infotainment system. If present in the vehicle, the legally required eCall

Emergency System cannot be switched off and cannot be deactivated → page 220, → page 220.

### WARNING

The following conditions may limit or prevent the execution of a manual or automatic emergency call:

- Your current emergency call location is in an area with no or insufficient mobile communications and satellite signal reception.
- The mobile communications network of telecommunication providers is not available in areas with sufficient mobile communications and satellite reception.
- No 2G/3G mobile communications network of telecommunication providers is available in areas with sufficient mobile communications and satellite signal reception. In this case, the emergency call reverts to the legally required eCall Emergency System, if present in the vehicle. If the legally required eCall Emergency System is not present in the vehicle, calls will be forwarded to the emergency call number 112.
- The Emergency Call Service is prohibited by law in some countries.
- There is no valid licence for the use of the Emergency Call Service.
- The components in the vehicle required for the manual or automatic emergency call are damaged or do not have sufficient electrical power.
- The emergency call service function has been deactivated. In this case, the emergency call reverts to the legally required eCall Emergency System, if present in the vehicle. No emergency call will be made if the legally required eCall Emergency System is not present in the vehicle. Also forwarding to the emergency number 112 does not take place.
- The vehicle ignition is not switched on.

### Initiating an emergency call manually

1. Press the button cover, if present, and fold down the button cover.
2. Press the button for the legally required eCall Emergency System → Fig. 54 until the indicator lamp flashes green.

The emergency call is now initiated and a voice connection is established to the Volkswagen emergency call centre.

If you have accidentally pressed the emergency call button, cancel the emergency call immediately.

1. Press the emergency call button again until the indicator lamp lights up green continuously.

 Press the button for the legally required eCall Emergency System → Fig. 54 only in an emergency.

### Automatic emergency call

An automatic emergency call is initiated only when the ignition is switched on.

A connection to the Volkswagen emergency call centre is automatically established immediately after the airbags or belt tensioners have been triggered. The automatic emergency call cannot be cancelled by pressing the button for the legally required eCall Emergency System → Fig. 54.

If queries from the Volkswagen emergency call centre remain unanswered, rescue measures are automatically initiated.

### Integrated battery

The integrated battery ensures that the emergency call service remains available for some time if the 12-volt vehicle battery is disconnected or faulty.

A corresponding message will be displayed in the instrument cluster display if the integrated battery is discharged or faulty. If this message is displayed, immediately go to a correspondingly qualified workshop and have the integrated battery replaced. Volkswagen recommends using a Volkswagen dealership.

 Have the integrated battery checked by a correspondingly qualified workshop after about 3 years and replaced if necessary. Volkswagen recommends using a Volkswagen dealership.

### Data transmission

In the event of an emergency call, the available data is transmitted to the Volkswagen emergency call centre to determine the necessary rescue measures.

The data on the vehicle location is continuously overwritten so that only the last ten stored locations required for correct functioning of the Emergency Call Service are available. The vehicle is therefore not permanently tracked.

The data relating to the emergency call is processed exclusively in order to ensure correct functioning of the Emergency Call Service. The data related to the emergency call is automatically deleted from the system 13 hours after the emergency call was triggered.

The following data is transmitted:

- Current position of the vehicle when the emergency call was triggered.
- Nine other positions shortly before the emergency call was triggered (route driven, a few km (around 2 mi)).

- Vehicle identification number (VIN).
- Type of vehicle drive.
- Vehicle type.
- Type of trigger (automatic or manual)
- Type of call.
- Direction in which the vehicle was moving when the emergency call was triggered.
- Accident severity.
- Accident direction.
- Time of collision.
- Reliability of positioning data.
- Data record version.
- Counter of data strings transferred per call.
- Determined number of passengers.
- Language selected in the Infotainment system.
- Optional data ID.

You can apply to view and delete the transmitted data by contacting the Volkswagen emergency call centre.

 Depending on the vehicle equipment and country, data transmission can be influenced by the privacy settings → page 221. The Emergency Call Service function can be guaranteed only if data transmission is fully possible.

 The function of the Emergency Call Service may be restricted if Infotainment systems have been retrofitted.

### Reverting to the legally required eCall Emergency System

In some situations, the Emergency Call Service may be restricted or unavailable. If the legally required eCall Emergency System is present in the vehicle, a voice connection will be established to a public emergency call centre if possible. In this case, the available data is transmitted to the public emergency call centre in order to determine the necessary rescue measures.

 It is possible to see whether the legally required eCall Emergency System is present in the vehicle in the Manage services area on the Infotainment system → page 220.



### Back-up to 112 emergency number

In some situations, the Emergency Call Service may be restricted or unavailable. If the legally required eCall Emergency System is not present in the vehicle, emergency calls will be made to the general emergency call number 112 if possible. In this case, only a voice-based connection is established. No da-

ta will be transmitted, e.g. regarding the vehicle or its location. <

## Troubleshooting



### Emergency Call Service is faulty

The indicator lamp in the emergency call button lights up red continuously . In addition, the message  Error: Emergency call function. Please visit workshop. may be displayed in the instrument cluster display.

There is a system fault in the Emergency Call Service. It may not be possible to make an emergency call.

1. Go to a correspondingly qualified workshop immediately and have the fault rectified. Volkswagen recommends using a Volkswagen dealership.

### Emergency Call Service is restricted

The indicator lamp in the emergency call button lights up red continuously . In addition, the message  Emergency call function restricted. Please visit workshop. may be displayed in the instrument cluster display.

The availability of the Emergency Call Service function is restricted. It is not possible to establish a voice connection to the Volkswagen emergency call centre, for example.

1. Go to a correspondingly qualified workshop immediately and have the fault rectified. Volkswagen recommends using a Volkswagen dealership. <



# Opening and closing

## Vehicle key

### Functions of the vehicle key



Fig. 55 Vehicle key.

- 1 Unlock the vehicle. All turn signals flash *twice*.
- 2 Unlock only the boot lid. All turn signals flash *twice*.
- 3 Lock the vehicle. All turn signals flash *once*.
- 4 Fold the key bit in and out.
- 5 Indicator lamp: flashes when button is pressed.

### **⚠ WARNING**

Careless or unsupervised use of the vehicle key can lead to accidents or injuries.

- Take all vehicle keys with you every time you leave the vehicle. Children or unauthorised persons could otherwise lock the doors and the boot lid, start the engine or switch on the ignition and thus operate electrical equipment, such as the electric windows.
- Never leave children or people requiring assistance alone in the vehicle. They could become trapped in the vehicle in an emergency and may not be able to get themselves to safety. For example, locked vehicles may be subjected to very high or very low temperatures depending on the season. This can cause serious injuries and illness or fatalities, especially among small children.

### **! NOTICE**

Protect the key from moisture and excessive vibration.

## Changing the button cell

Volkswagen recommends having the button cell replaced by a correspondingly qualified workshop → **!** Volkswagen recommends using a Volkswagen dealership.

### Vehicle key with key bit

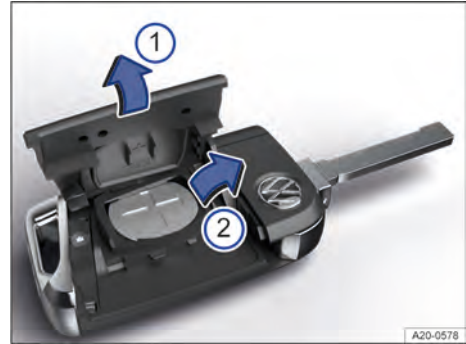

Fig. 56 Vehicle key: replacing the button cell (illustration).

- 1 Cover.
- 2 Button cell.

1. Fold out the key bit.
2. Lever off the cover → Fig. 56 **1** → **!**.
3. Lever the button cell out of the battery compartment → Fig. 56 **2**.
4. Press the new button cell into the battery compartment → **!**.
5. Press the cover onto the housing → Fig. 56 **1**.
6. Dispose of discharged batteries in an environmentally responsible way.

### **⚠ DANGER**

If button cell batteries are swallowed or get into the wind pipe, this can lead to serious or even fatal injuries due to suffocation or internal burns within a very short space of time.

- Call for medical help immediately if you suspect that someone has swallowed a button cell battery.
- If the battery cover cannot be closed, do not use the remote control.
- Always keep the remote control and key fob with button cells out of the reach of children.

## NOTICE

The vehicle key can be damaged if the button cell is not changed properly or if an unsuitable battery is used.

- Replace discharged batteries only with new batteries of the same voltage rating, size and specification.
- Pay attention to the correct polarity when inserting the battery.

 The type of batteries used in the remote control of your vehicle key may contain perchlorate. This may require special handling. Please observe all the legal requirements regarding the handling and disposal of these batteries → page 370. Volkswagen recommends having this service carried out by a correspondingly qualified workshop. Volkswagen recommends using a Volkswagen dealership. <

## Synchronising the vehicle key

If you cannot lock or unlock the vehicle with the vehicle key, synchronise the vehicle key or replace the button cell → page 71.

### Synchronising the vehicle key

1. Unfold key bit or remove spare key.
2. If necessary, remove the cover of the driver door handle → page 76.
3. Press the  button on the vehicle key.
4. Unlock the vehicle using the key bit.
5. Open the driver door.

If the vehicle has an anti-theft alarm, this will be triggered immediately → page 78.

6. Switch on the ignition.

The synchronisation process is complete.

## Troubleshooting

### Vehicle cannot be locked or unlocked

The remote control is subject to interference caused by obstacles, adverse weather conditions or other transmitters operating in the same frequency range in the vicinity of the vehicle, e.g. mobile telephones, or due to a weak or flat button cell.

**Or:** the central locking system has switched itself off temporarily to protect itself against overloading.

1. Close the driver door.

**Or:** synchronise the vehicle key → page 72.

**Or:** change the button cell in the vehicle key → page 71.

### Indicator lamp does not flash

If the indicator lamp in the vehicle key does not flash when pressing the button, the button cell in the vehicle key has to be replaced → page 71.

 Additional or replacement vehicle keys can be obtained from a Volkswagen dealership. <

## Keyless locking and starting system "Keyless Access"

### Introduction to the topic

The Keyless Access function allows the vehicle to be unlocked and locked without actively using the vehicle key. For this purpose, a valid vehicle key must be within close range of the vehicle. <

### Unlocking or locking the vehicle with Keyless Access

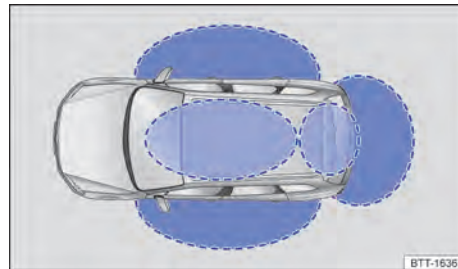

< Fig. 57 Keyless Access: operating ranges.

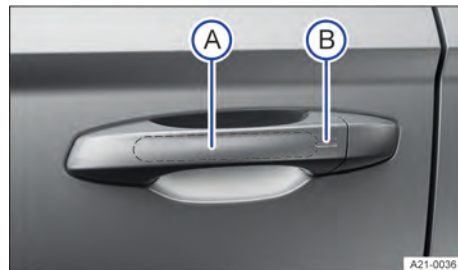

Fig. 58 In the door handle: sensors.

- (A)** Sensor surface on the inside of the driver or passenger door handle.
- (B)** Sensor surface on the outside of the driver or passenger door handle.

### Unlocking the vehicle

1. Tap sensor → Fig. 58 **(A)** on the inside of the driver or front passenger door handle.

### Locking the vehicle

1. Switch off the ignition.
2. Close driver or front passenger door.
3. Tap sensor → Fig. 58 **(B)** on the outside of the driver or front passenger door handle.

The vehicle unlocking procedure is confirmed by all the turn signals flashing *twice* and the locking procedure by the turn signals flashing *once*.

### Locking and unlocking the boot lid

When the vehicle is locked, the boot lid will be unlocked automatically if you open it when a vehicle key is located within the operating range of the boot lid → Fig. 57.

The boot lid is locked automatically after it is closed.

If the vehicle is completely unlocked, the boot lid will not lock automatically when closed.

### Temporarily deactivating Keyless Access

Keyless Access can be deactivated temporarily as described below so that the vehicle cannot be unlocked and started due to misuse by unauthorised third parties.

1. Lock the vehicle with the  button on the vehicle key.
2. Then touch the sensor on the outside of the door handle → Fig. 58 **(B)** once within 5 seconds. Do not put your hand around the door handle when doing this.  
Keyless Access is now temporarily deactivated.
3. To check deactivation, wait for at least 10 seconds and then pull the door handle again.

It should not be possible to open the door.

When the vehicle is next unlocked, it can be unlocked only using the vehicle key. The keyless locking and starting system Keyless Access is reactivated the next time the vehicle is unlocked.

### Operating the convenience functions

The electric windows can be closed automatically.

The glass roof is also closed in vehicles with a glass roof.

1. Place a finger on the sensor of the driver's or front passenger door handle → Fig. 58 **(B)** for a few seconds.

The sensor functions can be set in the **Vehicle settings** menu in the Infotainment system.

 The unlocking function is deactivated for a few seconds so that you can check that the vehicle has been locked successfully.

 A vehicle with dual clutch gearbox DSG® can only be locked when the parking lock **P** is engaged.

 The entire vehicle will be unlocked if the sensor is touched twice, even if a single door has already been unlocked. <

## Troubleshooting

### Keyless Access does not work

The function of the door handle sensors may be restricted if they become very dirty.

1. Clean the sensors.

### All turn signals flash four times

The vehicle key used last is still in the vehicle.

1. Remove the key and lock the vehicle.

### Automatic deactivation of the sensors

The sensors will be deactivated in the following circumstances:

- The vehicle is not unlocked or locked for an extended period.
- A sensor has been triggered an excessive number of times.

Activating sensors again:

1. Unlock the vehicle with the  button in the vehicle key.

### NOTICE

Please note that the sensors in the handles could be activated by a powerful jet of water or steam if a valid remote control key is within the operating range. If at least one window is open and the sensors in a door handle are continuously activated, all windows will close. All windows could open if the jet of water or steam is moved away from the door handle sensor surfaces briefly and then moved back again → page 72.

 If the message **Keyless system faulty** appears on the instrument cluster display, malfunctions may

occur in the Keyless Access system. Go to a correspondingly qualified workshop. Volkswagen recommends using a Volkswagen dealership.

## Doors and central locking button

### Introduction to the topic

The doors can be locked manually and, in some cases, also unlocked manually, if the vehicle key or central locking fails, for example.

The central locking system enables you to centrally lock and unlock all the doors, the boot lid and the tank flap of the vehicle.

The vehicle can be locked if the ignition has been switched off or the driver has switched off the engine before leaving the vehicle.

A symbol in the instrument cluster display indicates if one or more doors are not closed properly → page 17. **Do not drive on!** Open the door in question and then close it again.

This symbol is also visible when the ignition is switched off and will go out a few seconds after the vehicle has been locked when all doors are closed.

### WARNING

Any door that is not properly closed could open suddenly while the vehicle is in motion. This could lead to severe injuries.

- Stop immediately and close the door.
- Make sure that the door is closed properly and that the lock has engaged. The closed door must be flush with the surrounding body panels.
- Open or close the doors only when there is no-one in the movement path of the doors.

### WARNING

Any door being held open by the door arrester could close unexpectedly in strong winds or if the vehicle is on a slope. This could lead to injuries.

- Always hold the door handle firmly when opening and closing doors.

### WARNING

The opening and closing paths of the doors and boot lid are potential danger areas where injury can occur.

- Open or close the doors and boot lid only when there is no-one in their movement path.

### WARNING

Careless locking of the doors can cause serious injuries.

- If the vehicle is locked from the outside, the doors and electric windows cannot be opened from the inside.
- The central locking system locks all doors. Locking the vehicle from the inside can prevent accidental opening of the doors and unauthorised persons from entering the vehicle. However, locked doors can delay assistance to passengers inside the vehicle in the event of an accident or emergency.
- Never leave children or people requiring assistance alone in the vehicle. All doors can be locked from the inside using the central locking button. This may mean that people lock themselves in the vehicle. People locked in the vehicle may be subjected to very high or very low temperatures.
- Temperatures inside a locked vehicle may be extremely hot or cold depending on the season. This can cause serious injuries and illness or fatalities, especially among small children.
- Never leave anyone inside a locked vehicle. People in the vehicle could become trapped in an emergency and may not be able to get themselves to safety.

### NOTICE

When carrying out manual opening or closing, remove parts carefully and install them again correctly in order to avoid damage to the vehicle.

You can save some settings in the user account in personalisation.

### Indicator lamp in the driver door

Please refer to **WARNING** and **NOTICE** at the start of the chapter on page 74.

The central locking indicator lamp is located in the driver door → page 10.

*The vehicle is locked:* A red LED flashes for approximately two seconds, firstly at short intervals and then more slowly. The indicator lamp does *not* flash if the vehicle was locked with the central locking button in the driver door → page 75.

## Automatic locking and unlocking

📖 Please refer to ⚠️ and ⌚ at the start of the chapter on page 74.

Depending on the vehicle equipment, the settings for central locking can be made in the Vehicle settings menu in the Infotainment system.

### Automatic locking (Auto Lock)

The vehicle locks itself automatically at speeds above approximately 15 km/h (9 mph). The indicator lamp  in the central locking button will light up yellow when the vehicle is locked.

### Automatic unlocking (Auto Unlock)

All vehicle doors and the boot lid are automatically unlocked if one of the following conditions applies:

- The vehicle is at a standstill and the vehicle key has been removed.
- *On vehicles with automatic gearbox:* the parking lock **P** is engaged and the ignition is switched off.
- **Or:** the door release lever has been operated. This applies at speeds up to 15 km/h (9 mph).
- **Or:** in an accident where the airbags have been triggered → page 78.

 Automatic unlocking gives emergency responders access to the vehicle.

## Central locking button

📖 Please refer to ⚠️ and ⌚ at the start of the chapter on page 74.



**Fig. 59** In the driver door: central locking button (illustration).

① Central locking button.



**Fig. 60** In the driver door: button for opening the boot lid electrically (illustration).

① Button for electrically opening the boot lid.

 - unlock the vehicle.

 - lock the vehicle.

 - open the boot lid.

If the  button in the driver door is pressed, only the boot lid opens. All doors remain locked.

The central locking button functions with the ignition switched on or off only when all doors are closed.



If the vehicle has been locked from outside with the vehicle key, the central locking buttons do not work.

◀ Please note the following when using the central locking button to lock the vehicle from inside:

- The indicator lamp  in the button lights up yellow when all doors are closed and locked.
- The anti-theft alarm will **not** be activated → page 78.

The doors can be opened from the inside by pulling the door release handle. The indicator lamp  in the button goes out. The unopened doors and boot lid remain locked and cannot be opened from the outside. ▶

## Opening and closing the driver door manually

Please refer to  and  at the start of the chapter on page 74.



**Fig. 61** Handle on the driver door: levering off the cover.

When manual locking takes place, all doors are locked. With manual unlocking, only the driver door is unlocked.



Observe the information about the anti-theft alarm → page 78.

1. Place the key bit or spare key on the notch of the driver's door handle from below.
2. Hold your index finger under the key bit.
3. Lever the cap off with the vehicle key in the direction of the arrow → Fig. 61.
4. Insert the key bit into the lock cylinder and lock or unlock the vehicle.
5. Pull the door handle and fit the cap again.

### Things to note when unlocking manually

- The alarm is triggered when the driver door is opened → page 78.
- The vehicle must be started manually once unlocked → page 138.
- Switch on the ignition to switch off the alarm.

The electronic immobiliser recognises a valid vehicle key.

 The anti-theft alarm is not activated when the vehicle is locked manually using the key bit → page 78. 

## Manually closing the front passenger door and rear doors

Please refer to  and  at the start of the chapter on page 74.





**Fig. 62** In the front edge of the rear right-hand door: manually locking the vehicle with the vehicle key (illustration).

The front passenger door and the rear doors can be locked manually.

The anti-theft alarm is **not** activated in this case → page 78.

1. Open the door.
2. Remove the rubber seal  from the end face of the door.
3. Insert the key bit or manual key into the slot and turn → Fig. 62.
4. Secure the rubber seal again.
5. Check that the door is locked.
6. The vehicle should be checked by a correspondingly qualified workshop as soon as possible. Volkswagen recommends using a Volkswagen dealership.

A door that has been locked manually will be unlocked again if the vehicle is unlocked or the door in question is opened from the inside.

 The doors can be unlocked and opened from the inside by pulling the door release handle. 

## Childproof lock

📖 Please refer to ⚠️ and ⓘ at the start of the chapter on page 74.

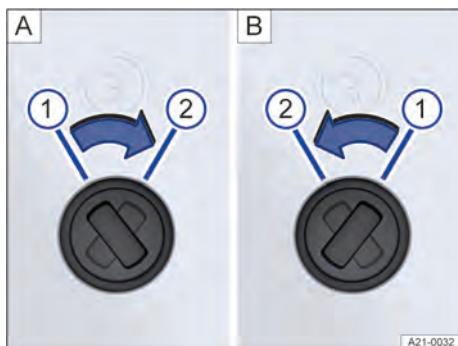

Fig. 63 Childproof lock: **A** rear left door, **B** rear right door.

- ① Childproof lock is switched off.
- ② Childproof lock is switched on.

The childproof lock is located in the inner door panel of the rear doors.

The childproof lock prevents the rear doors being opened from the inside.

When the childproof lock is activated, the door can only be opened from the outside.

### Switching the childproof lock on and off

1. Unlock the vehicle and open the appropriate rear door.
2. Move the slot to the corresponding position.

### ⚠️ WARNING

The door cannot be opened from the inside when the childproof lock is activated.

- Never leave children or people requiring assistance alone in the vehicle when the doors are locked. This may mean that these people lock themselves in the vehicle. They could become trapped in the vehicle in an emergency and may not be able to get themselves to safety. People locked in the vehicle may be subjected to very high or very low temperatures.
- Temperatures inside a locked vehicle may be extremely hot or cold depending on the season. This can cause serious injuries and illness or fatalities, especially among small children.

## SAFELOCK

📖 Please refer to ⚠️ and ⓘ at the start of the chapter on page 74.

Depending on the vehicle equipment level, the vehicle may have a SAFELOCK mechanism.

The SAFELOCK deactivates the door release levers if the vehicle has been locked. This makes it more difficult to break into the vehicle. The doors can no longer be opened from the inside → ⚠️.

### Deactivating SAFELOCK

The SAFELOCK can be deactivated in one of the following ways:

- Press the button on the vehicle key again **within 2 seconds**.
- *On vehicles with the keyless locking and starting system Keyless Access:* Touch the sensor on the outside of the door handle again **within 2 seconds** → page 72.
- Switch on the ignition.
- **Or:** deactivate the interior monitoring system and the anti-tow alarm → page 79.

Depending on the equipment level, temporarily deactivate the interior monitoring and the anti-tow alarm in the **Vehicle Settings** menu in the Infotainment system before locking the vehicle → page 79.

There may be an indication of the activated SAFELOCK in the display of the instrument cluster.

The following applies when SAFELOCK is deactivated:

- The vehicle can be unlocked and opened from the inside using the door release lever.
- The anti-theft alarm is active → page 78.
- The interior monitoring and anti-tow alarm are deactivated → page 79.

### ⚠️ WARNING

Always take care when using the SAFELOCK as you could cause serious injuries.

- Never leave anybody in the vehicle if the vehicle has been locked using the vehicle key. The doors can no longer be opened from the inside once the SAFELOCK is activated.

ⓘ If you unlock the driver door mechanically using the vehicle key, only the driver door is unlocked, and not the whole vehicle. The doors are released (but not unlocked) and the central locking button is activated only when you switch on the ignition.

## Troubleshooting

📖 Please refer to ▲ and ⌚ at the start of the chapter on page 74.

### Indicator lamp lights up continuously

The red LED in the vehicle door flashes at short intervals and then lights up continuously.

There is a fault in the locking system.

1. Go to a correspondingly qualified workshop. Volkswagen recommends using a Volkswagen dealership.

### Turn signals do not flash

The turn signals do *not* flash to confirm that the vehicle has been locked.

1. Check whether at least one of the doors, the boot lid or the bonnet is not closed.

### Vehicle locks itself automatically

The vehicle locks again automatically after approximately 45 seconds if one of the following conditions applies:

- The vehicle was unlocked but not opened.
- The ignition was not switched on.
- The boot lid was not opened.

### Response when locking the vehicle with a second vehicle key

*On vehicles with the keyless locking and starting system Keyless Access:* the vehicle key inside the vehicle is disabled for starting the engine as soon as the vehicle is locked from outside with a second vehicle key. However, an emergency start is possible → page 142.

1. To enable the vehicle key inside the vehicle for a normal engine start, press the ⏏ button on the vehicle key inside the vehicle → page 140.

### Locking the vehicle after airbags have been triggered

The entire vehicle is unlocked if the airbags are activated during an accident. Depending on the extent of the damage, the vehicle can be locked as follows after an accident.

1. Switch off the ignition.
2. Open the driver's door and close it again.
3. Lock the vehicle.

### Automatic deactivation of the sensors

The sensors will be deactivated in the following circumstances:

- The vehicle is not unlocked or locked for an extended period.
- A sensor has been triggered an excessive number of times.

Activating sensors again:

1. Unlock the vehicle with the ⏏ button in the vehicle key.

### ⚠ NOTICE

Please note that the sensors in the handles could be activated by a powerful jet of water or steam if a valid remote control key is within the operating range. If at least one window is open and the sensors in a door handle are continuously activated, all windows will close → page 72.

ⓘ It may not be possible to lock or unlock the vehicle using the Keyless Access if the 12-volt vehicle battery or button cell in the vehicle key is weak or discharged. The vehicle can be locked or unlocked manually → page 74.

ⓘ If there is no valid vehicle key in the vehicle or if it is not detected, a corresponding display will be shown on the instrument cluster display. This may occur if the vehicle key is disrupted by another radio signal or is covered by another item such as an aluminium suitcase → page 138. ◀

## Anti-theft alarm

Depending on the vehicle equipment level, the vehicle may have an anti-theft alarm.

The anti-theft alarm monitors the doors, bonnet and the boot lid.

The anti-theft alarm is automatically activated when the vehicle is locked.

If the vehicle is not opened with a valid vehicle key, the anti-theft alarm is triggered and emits acoustic and visual warning signals for up to 5 minutes.

### When does the system trigger an alarm?

- When a door that was unlocked mechanically with the vehicle key is opened.
- When the bonnet is opened.
- When the boot lid is opened.
- If the ignition is switched on using an invalid key.
- If the 12-volt vehicle battery is disconnected.





- If there is movement inside the vehicle (in vehicles with interior monitoring) → page 79.
- If the vehicle is lifted or towed (vehicles with anti-tow alarm) → page 79.
- If the vehicle is transported on a car ferry or by rail (vehicles with anti-tow alarm or interior monitoring) → page 79.

#### Switching off the alarm

1. Unlock the vehicle using the unlocking button  on the vehicle key.  
**Or:** switch on the ignition using a valid vehicle key.  
A short alarm lasting around 1 second may sound.
2. *On vehicles with locking and starting system Keyless Access:* grip the door handle → page 72.

 The anti-theft alarm will not function correctly if the 12-volt vehicle battery is weak or discharged.

 When the 12-volt vehicle battery is disconnected, the anti-theft alarm system can be triggered.

 If the connection to a trailer connected to the anti-theft alarm system is interrupted, the anti-theft alarm system may be triggered → page 273. <

## Interior monitoring system and anti-tow alarm

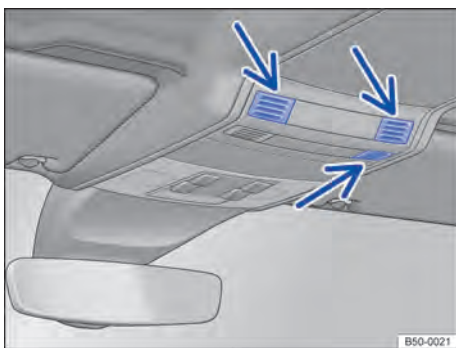

**Fig. 64** In the roof console: sensors for the interior monitoring system (arrows).

In some markets, the vehicle is equipped with interior monitoring and an anti-tow alarm, depending on the vehicle specification.

The interior monitoring system triggers an alarm if movement is detected in the interior of a locked vehicle → Fig. 64.

The anti-tow alarm will be triggered if the vehicle is lifted.

#### Switching on the interior monitoring system and anti-tow alarm

Close the stowage compartments in the roof console so that the sensors can function.

1. Close the windows, tilting and sliding panoramic sunroof, doors and boot lid.
2. Press the locking button once.

The interior monitoring system and anti-tow alarm are activated.

Depending on the equipment, the function of interior monitoring may be impaired if a load guard is used.

#### Temporarily switching off the interior monitoring system and anti-tow alarm

With some equipment levels, the interior monitoring system and the tow-away protection can be switched off temporarily in the **Vehicle settings** menu in the Infotainment system.

1. Switch on the ignition.
2. Deactivate the interior monitoring and the anti-tow alarm in the **Vehicle settings** menu in the Infotainment system.
3. Close all doors and the boot lid.
4. Lock the vehicle using the vehicle key.

The interior monitoring and anti-towing alarm are deactivated until the next time the vehicle is locked.

#### We recommend deactivating the interior monitoring system and tow-away protection in the following situations:

- If any people or animals are to remain in the vehicle interior for a short period.
- If the vehicle is to be loaded onto another vehicle.
- If the vehicle is being transported.
- If the vehicle is going to be towed with one axle off the ground.
- If the vehicle is to be parked in a two-storey garage.
- If the vehicle is to be parked in a car wash.

#### Risk of false alarms for the interior monitoring system

Interior monitoring can only work properly if the vehicle is completely closed. Observe the legal require-

ments. A false alarm can be triggered in the following situations:

- If one or more windows or the glass roof are fully or partially open.
- If lightweight items such as loose pieces of paper or items hung from the interior mirror are left in the vehicle.
- If the vibration alarm of a mobile telephone is switched on.

 Permanent deactivation of interior monitoring and the anti-tow alarm is not possible.

 If doors or the boot lid are still open when the anti-theft alarm is activated, only the anti-theft alarm is activated. The anti-tow alarm is not activated until all doors and the boot lid are closed.

 SAFELock is also deactivated when the interior monitoring system and anti-tow alarm are switched off, depending on equipment → page 77. <

## Boot lid

### Introduction to the topic

The boot lid is unlocked and locked together with the doors.

In vehicles with Keyless Access, the boot lid is automatically unlocked upon opening → page 72.

If single door or vehicle side opening is activated in the opening and closing settings in the Infotainment system, the  button on the vehicle key must be pressed **twice** to release the boot lid.

On vehicles with Keyless Access, it is necessary to operate the sensor on the inside of the driver or front passenger door handle **twice** for this.

### WARNING

Incorrect and unsupervised unlocking, opening or closing of the boot lid can cause accidents and serious injuries.

- Open or close the boot lid only when there is no-one in the movement path of the boot lid.
- After closing the boot lid, always check that the boot lid is properly closed. The closed boot lid must be flush with the surrounding body panels.
- Always keep the boot lid closed while the vehicle is in motion.
- Never open the boot lid when loads, e.g. bicycles, are secured to it. The boot lid may close under its own weight due to the additional load.

Support the boot lid if necessary or remove the load beforehand.

- Close and lock the boot lid and all doors when the vehicle is not in use. Ensure that no one remains in the vehicle.
- Never leave children playing unattended in or around the vehicle, especially when the boot lid is open. Children could climb into the luggage compartment and shut the boot lid, thereby trapping themselves inside. Temperatures inside a locked vehicle may be extremely hot or cold depending on the season. This can cause serious injuries and illness or fatalities, especially among small children.

### WARNING

Serious injuries can occur if the boot lid is unlocked or opened incorrectly or without due care and attention.

- It may not always be apparent that the boot lid is unlocked, for example when a loaded luggage carrier is attached to it. If unlocked, the boot lid may open suddenly while the vehicle is in motion.

### WARNING

If there is a large amount of snow or a heavy load on the boot lid, the boot lid may lower by itself and cause serious injuries due to the additional weight.

- Never open the boot lid if it is covered by a large amount of snow or a load is attached to it, e.g. a luggage carrier.
- Remove the snow or load before opening the boot lid.

### WARNING

Do not close the boot lid by pushing it down with your hand on the window. The rear window may shatter and cause injuries.

### NOTICE

Never use the opening mechanism to fix or hold a load. This could lead to damage that makes it impossible to close the boot lid.



### NOTICE

Never use the rear window wiper to fix a load or hold on to it. This may result in damage where the rear window wiper is torn off.

## NOTICE

Never use the rear spoiler to fix or hold a load. This may result in damage where the rear spoiler is torn off.

## Opening and closing the boot lid

Please refer to  and  at the start of the chapter on page 80.





**Fig. 65** In the boot lid: button for opening the boot lid (illustration).



**Fig. 66** In the open boot lid: handle for closing the boot lid.

### Opening the boot lid

1. To unlock the boot lid, press the  or  button on the vehicle key.
2. Lift the boot lid with the button → Fig. 65.

### Closing the boot lid

1. Pull the boot lid down by the handle in the interior trim with sufficient momentum so that it engages in the lock → Fig. 66, → .

A symbol in the instrument cluster display indicates that the boot lid is opened or not properly closed.

The boot lid is locked automatically when the vehicle is moving.

## WARNING



Serious injuries can occur if the boot lid is closed incorrectly or without due care and attention.

- When opening the boot lid, make sure the boot lid is moved fully up.
- When closing the boot lid, make sure that no-one has their hands in the direct path of the boot lid as it moves.



If the boot lid is not opened within a few minutes after unlocking, it automatically locks again.

## Electrically opening and closing the boot lid

Please refer to  and  at the start of the chapter on page 80.



**Fig. 67** In the driver door: release button for the boot lid.

- ① Release button.

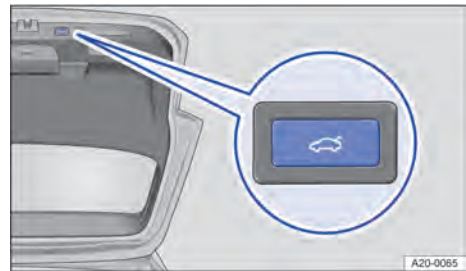

**Fig. 68** In the open boot lid: button for closing boot lid electrically.

### Electrically opening the boot lid

1. *5-seater*: To unlock the boot lid, briefly press the  button on the vehicle key.

**Or:** pull the  button in the driver door upwards → Fig. 67.

The parking lock **P** must be inserted.

**Or:** press the button on the boot lid.

The boot lid will then open.

### Electrically closing the boot lid

1. Press the button in the open boot lid → Fig. 68.

*5-seater:* **Or:** with the ignition on, pull the  button in the driver door up until the boot lid is closed.

*5-seater:* **Or:** in vehicles with keyless locking and starting system Keyless Access: briefly press and hold the  button on the vehicle key. The vehicle key must be in the operating range of the boot lid.

**Or:** close the boot lid by moving it manually until the boot lid closes by itself.

The boot lid is closed.

### Interrupting the opening or closing procedure

1. Press one of the  buttons during the opening or closing procedure.

**Or:** press the button on the boot lid during the opening or closing process → Fig. 68.

The boot lid can not be moved by hand. You will need to use more force than usual.

Pressing the  button again will move the boot lid back to its starting position.

### Acoustic signals

If the boot lid is opened or closed from the vehicle interior or with the vehicle key, acoustic signals will sound.

### Changing and storing the opening angle

If the area behind or above the vehicle is smaller than the path of the boot lid, the opening angle of the boot lid can be changed.

1. Stop the opening procedure at the desired open position.  
The boot lid must be at least half open.
2. In the boot lid, press and hold the  button until the hazard warning lights flash → Fig. 68.

The changed opening angle will be stored.

The hazard warning lights flash and an acoustic signal sounds to confirm that the changed opening angle has been stored.

### Resetting and storing the opening angle

The opening angle will have to be reset and stored again in order to fully open the boot lid again.

1. Press the open boot lid up by hand to the stop. You will need to use more force than usual.
2. In the boot lid, press and hold the  → Fig. 68 button until the hazard warning lights flash.



The opening angle will be reset.

The hazard warning lights flash and an acoustic signal sounds to confirm that the opening angle has been reset.

### NOTICE

Before opening or closing the boot lid, check whether there is enough clearance to open or close the boot lid, e.g. in garages. <

### Boot lid with Easy Open motion sensor

 Please refer to  and  at the start of the chapter on page 80.



**Fig. 69** Illustration of the boot lid with sensor-controlled opening (Easy Open).

The boot lid can be unlocked and opened with a foot movement if there is a valid vehicle key within the operating range of the boot lid.

1. Stand centrally behind the bumper.
2. Move your foot and shin quickly towards the bumper → Fig. 69.
3. Then quickly move your foot and shin away from the bumper again.

Visual feedback is provided via the turn signals. The boot lid opens.

## Activating or deactivating Easy Open

Easy Open can be activated and deactivated in the Infotainment system:

1. Select the **Vehicle** menu.
2. Select the **Exterior** submenu.
3. Swipe sideways and activate or deactivate **Easy Open**.

Or:

1. Swipe sideways and select the **Central locking** menu option.
2. Scroll down the list and activate or deactivate **Easy Open**.

If Easy Open is activated, Easy Close is also active, depending on the vehicle equipment → page 83.

The Easy Open function is available only when Keyless Access is activated → page 72.

### CAUTION

If a valid vehicle key is located close to the boot lid, the Easy Open function can sometimes be operated accidentally, causing the boot lid to open, e.g. when sweeping underneath the rear bumper, if a powerful jet of water or steam is directed at the bumper, or if maintenance and repair work is carried out in the area around the rear bumper. If the boot lid is opened by mistake it can cause damage to anyone in the path of the boot lid and material damage.

- Always make sure that there are no valid vehicle keys left unattended in the operating range of the boot lid.
- Always switch off the Easy Open function via the Infotainment system before any maintenance or repair work is carried out.
- Always switch off the Easy Open function via the Infotainment system before washing the vehicle.
- Always switch off the Easy Open/Easy Close function via the Infotainment system before fitting a bicycle carrier or attaching a trailer → page 273.

## Closing the boot lid automatically with Easy Close

 Please refer to  and  at the start of the chapter on page 80.



**Fig. 70** Illustration of the boot lid with sensor-controlled closing (Easy Close).

The Easy Close function can be activated only if there is a valid vehicle key in the operating range of the boot lid.

1. Stand centrally behind the bumper.
2. Move your foot and shin quickly towards the bumper → Fig. 70.
3. Then quickly move your foot and shin away from the bumper again.

Easy Close is activated for around 20 seconds. An acoustic signal confirms activation.

The boot lid will be closed as soon as all valid vehicle keys have been removed from the operating range of the boot lid.

The boot lid will lock again automatically, provided that the vehicle had been locked beforehand and as long as there is no valid vehicle key inside the vehicle.

Easy Close allows a maximum of one vehicle key to be locked into the boot.

The closing operation will be interrupted as soon as a vehicle key comes within the operating range again. The boot lid will then open again.

### Activating or deactivating Easy Close

The Easy Close function can be activated and deactivated together with the Easy Open function in the **Vehicle** menu in the Infotainment system → page 82.

The Easy Close function is available only when Keyless Access is activated → page 72.

## ⚠ CAUTION

If a valid vehicle key is located close to the boot lid, the Easy Close function can sometimes be operated accidentally, causing the boot lid to close, for example when sweeping underneath the rear bumper or if maintenance and repair work is carried out in the area around the rear bumper. If the boot lid is closed by mistake, this can cause injuries to persons in the path of the boot lid and material damage.

- Always make sure that there are no valid vehicle keys left unattended in the operating range of the boot lid.
- Always switch off the Easy Open function via the Infotainment system before any maintenance or repair work is carried out.
- Always switch off the Easy Open function via the Infotainment system before washing the vehicle.
- Always switch off the Easy Open/Easy Close function via the Infotainment system before fitting a bicycle carrier or attaching a trailer → page 273.

**i** The closing operation will be automatically interrupted if another boot lid function is activated during closing or if objects are detected in the area of the boot lid.

**i** The boot lid locks automatically after closing if the vehicle is locked and the Easy Close function is active. If the vehicle is completely unlocked and the Easy Close function is operated, the boot lid will not lock automatically after closing. ◀

## Unlocking the boot lid manually

📖 Please refer to ⚠ and ⌚ at the start of the chapter on page 80.



**Fig. 71** In the tailgate: opening the warning triangle holder.



**Fig. 72** In the boot lid: manual release mechanism for the boot lid.

### Unlocking the boot lid manually

1. Turn the lock of the warning triangle holder 90° anticlockwise → Fig. 71.
2. Open the warning triangle holder and remove the warning triangle.
3. To unlock the boot lid, insert a suitable object in the opening in the release lever and press in the direction of the arrow → Fig. 72. ◀

## Troubleshooting

📖 Please refer to ⚠️ and Ⓜ️ at the start of the chapter on page 80.

### Boot lid cannot be opened or closed

- Check whether the boot lid is blocked by an obstacle. The boot lid can be moved by hand. You will need to use more force than usual.
- The drive switches off automatically in order to prevent overheating if the boot lid is operated too frequently within a short space of time. Until the drive has cooled off, increased effort may be required to open and closed the boot lid by hand.
- When towing a trailer, the electric rear lid can only be opened and closed at the boot lid → page 273.
- The boot lid must be closed by hand if the 12-volt vehicle battery or fuse is disconnected or faulty.

### All turn signals flash four times

The vehicle key used last is still in the vehicle.

1. Remove the key and lock the vehicle.

### Boot lid is stiff

At outside temperatures around freezing point, the opening mechanism cannot always lift the partially opened boot lid automatically.

1. Guide the boot lid further upwards by hand.

### The Easy Open sensor-controlled luggage compartment opener is not working

- Easy Open works only when the ignition is switched off.
- Clean the sensors in the rear bumper.
- The towing bracket is swivelled out → page 273.
- A towing bracket has been retrofitted to the vehicle → page 273.
- In order to prevent incorrect triggering, Easy Open may be deactivated in conditions with heavy precipitation.

### Automatic closing Easy Close is not working

- Switch off the ignition and close the driver door.
- The boot lid must be at least half open.
- Unhitch the trailer → page 273.
- There is more than one vehicle key in the luggage compartment.
- Press the Easy Close button again.

## Windows

### Opening and closing windows

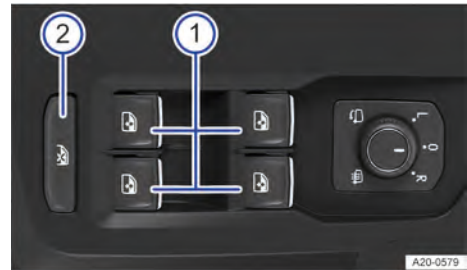

Fig. 73 In the driver door: electric window buttons.

- ① Open windows: press the button.  
Close windows: pull the button.
- ② Press to disable the electric window buttons in the rear doors.  
The button is located only in the driver door.

The windows can still be operated using the buttons several minutes after the ignition has been switched off, provided that the driver door and front passenger door are not opened.

### One-touch opening and closing

One-touch opening and closing makes it possible to fully open and close the windows. The individual buttons do not have to be held down to do this.

### One-touch closing

1. Briefly pull the button for the corresponding window up to the second position.

### One-touch opening

1. Briefly press the button for the corresponding window down to the second position.

### Stopping the one-touch function

1. Press or pull the button for the appropriate window again.

### Convenience opening and closing

The windows can be opened and closed from outside the vehicle using the vehicle key when the ignition is switched off:

1. Press and hold the locking or unlocking button on the vehicle key.

*Or: in vehicles with the keyless locking and starting system Keyless Access: place your fin-*

ger on the locking sensor in the door handle for a few seconds until the windows are closed → page 72. The vehicle key must also be within the operating range.

2. To interrupt this function, let go of the locking or unlocking button.

**Or:** to interrupt the function, take your finger off the sensor.

A valid vehicle key must be located within close range. Once all windows and the glass roof have been closed, all turn signals will flash *once* as confirmation.

Set the convenience opening settings in the **Vehicle settings** menu in the Infotainment system.

### WARNING

Careless or unsupervised use of the electric windows can cause serious injuries.

- Open or close electric windows only when there is no-one in the operating path of the windows.
- Never leave children or people requiring assistance alone in the vehicle when the vehicle is locked. The windows can no longer be opened in an emergency.
- Always take all vehicle keys with you every time you leave the vehicle. The windows can still be operated using the buttons several minutes after the ignition has been switched off, provided that the driver door and front passenger door are not opened.
- When transporting children on the rear bench seat, always deactivate the rear electric windows using the safety button so that they cannot be opened or closed.

### NOTICE

During sudden rain showers, water can enter the vehicle interior via open windows and cause damage to the vehicle.

 One-touch opening and closing and the roll-back function will not work if there is a fault in the electric windows. Go to a correspondingly qualified workshop. Volkswagen recommends using a Volkswagen dealership.

 Convenience opening and closing works only when one-touch opening and closing is activated for all electric windows.

 Some settings can be saved in the user accounts of the personalisation function and therefore change automatically when the user account is changed → page 41.

## Electric window roll-back function

The roll-back function for the electric windows can reduce the risk of injuries when the windows are closing.

If the window is not able to close because it is stiff or because of an obstruction, the window will immediately open again → .

1. Check to see why the window has not closed.
2. Try to close the window again.

If the window closing process is interrupted again, the roll-back function will be disabled for a few seconds.

If the window still cannot be closed, the window stops where it is. To close the window without the roll-back function, press the button again within a few seconds → .

### Closing windows without roll-back function

1. Attempt to close the window again within a few seconds by holding the button. The roll-back function is deactivated in the process!



If the closing procedure takes longer than several seconds, the roll-back function will be reactivated. If it is still stiff or obstructed, the window will stop and open again automatically.

2. Go to a correspondingly qualified workshop if the window still cannot be closed. Volkswagen recommends using a Volkswagen dealership.

### WARNING

Closing the electric windows without the roll-back function can lead to severe injuries.

- Always take care when closing the windows.
- Ensure that nobody obstructs the path of the window, especially if a window is being closed when the roll-back function is not active.
- The roll-back function does not prevent fingers or other body parts from being pressed against the window frame and sustaining injury.

 The roll-back function is also activated if the convenience closing function on the vehicle key is used to close the windows. 

## Troubleshooting

### One-touch opening and closing does not work

 One-touch opening and closing is deactivated if the 12-volt vehicle battery has been disconnected or



discharged while the windows were not fully closed. The function will have to be reset.

1. Switch on the ignition.
2. Close all windows and doors.
3. Pull up the button for the window and hold it in this position for a few seconds.
4. Let go of the button, then pull it up again and hold it in this position.

One-touch opening and closing is now ready for operation.

The one-touch function can be restored for individual windows or for several windows at the same time.

#### Touch panels react differently than expected

Moisture, dirt and grease can impede the functioning of the touch panels.

1. Always keep touch panels clean and dry.

## Glass roof

### Opening and closing the glass roof

The term glass roof is used as a standard term for the tilting and sliding panoramic sunroof.

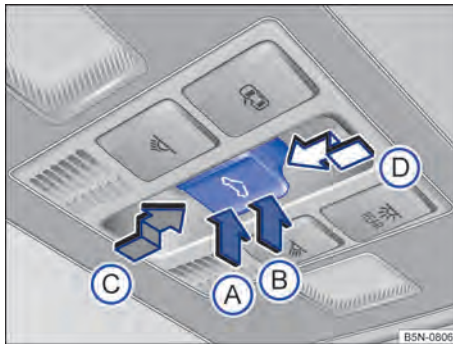



Fig. 74 In the roof: button for the glass roof.

- (A) Closing the tilted glass roof.
- (B) Tilting the glass roof.
- (C) Opening the glass roof or stopping the one-touch function.
- (D) Closing the glass roof or stopping the one-touch function.

The glass roof is a roof opening system featuring two glass elements. The rear glass element is fixed in place and cannot be opened.

The  button has two positions.

**First stage:** fully or partially tilt, open or close the roof.

**Second stage:** automatically move the roof to the respective limit position. Press the button again to stop the one-touch function.

#### Tilting the glass roof

- Manual operation: push button → Fig. 74 (B) to the first position.
- One-touch function: push button (B) to the second position.

#### Closing the tilted glass roof

- Manual operation: push button (A) to the first position.
- One-touch function: push button (A) to the second position.

#### Opening the glass roof

- Manual operation: push button (C) to the first position.
- One-touch function up to convenience position: push button (C) to the second position.

#### Closing the glass roof

- Manual operation: push button (D) to the first position.
- One-touch function: push button (D) to the second position.

#### Stopping the one-touch function for the opening or closing procedure

1. Press button (C) or (D) again.

#### WARNING

Careless or unsupervised use of the glass roof can cause serious injuries.

- Open or close the glass roof only when there is no-one in the operating path of the roof.
- Always take all vehicle keys with you every time you leave the vehicle.
- Never leave children or people requiring assistance alone in the car, particularly if they have access to the vehicle key. Unsupervised use of the vehicle key can lock the vehicle, start the engine, switch on the ignition and operate the glass roof.
- The glass roof can still be operated for a short time after the ignition has been switched off,

provided the driver door or front passenger door are not opened.

## NOTICE

- At winter temperatures, always remove ice and snow from the vehicle roof before opening or tilting the glass roof in order to avoid damage.
- Always close the glass roof before leaving the vehicle or when it starts to rain. Any rain entering the vehicle when the glass roof is open or tilted could cause considerable damage to the electrical system. This can result in subsequent damage to the vehicle.
- When using the roof carrier, the glass roof must be kept closed.

 Remove leaves and other loose items from the glass roof guide rails at regular intervals using a vacuum cleaner or by hand.

 The roll-back function will not work properly if there is a fault with the glass roof. Go to a correspondingly qualified workshop. Volkswagen recommends using a Volkswagen dealership.

 You can save some settings in the user accounts of the personalisation function → page 41.

## Convenience opening or closing of the glass roof

### Convenience opening and closing

The glass roof can be opened and closed from outside the vehicle using the vehicle key:

- *Not applicable for USA or Canada:* Press and hold the locking or unlocking button on the vehicle key. The glass roof is tilted or closed.
- *On vehicles with the keyless locking and starting system Keyless Access:* Place your finger on the locking sensor in the door handle for a few seconds until the glass roof is closed → page 72.
- Release the locking or unlocking button to interrupt this function.

Convenience closing closes all windows in the doors and the glass roof. Once all windows and the glass roof have been closed, all turn signals will flash *once* as confirmation.

Glass roof settings can be made in the vehicle settings in the Infotainment system → page 17.

 Some settings can be stored in the user accounts of the personalisation function and therefore change when the user account changes. <

## Glass roof roll-back function

The roll-back function reduces the risk of crush injuries → . If the glass roof is impeded during the closing process, it will open again immediately.

1. Check to see why the glass roof has not closed.
2. Try to close the glass roof again.
3. If the glass roof still cannot be closed, close it without the roll-back function.

### Closing the glass roof without the roll-back function

1. Press the  button to the second position until the glass roof has fully closed → page 87.

The glass roof will now close without the roll-back function.

2. Go to a correspondingly qualified workshop if the glass roof still cannot be closed. Volkswagen recommends using a Volkswagen dealership.

If you let go of the switch during the closing procedure, the glass roof will open automatically. <

## WARNING

Closing the glass roof without the roll-back function can cause serious injuries.

- Always take care when closing the glass roof.
- Ensure that nobody obstructs the path of the glass roof, especially if the roll-back function is not active.
- The roll-back function does not prevent fingers or other body parts from being pressed against the roof frame and sustaining injury.

 The roll-back function is also activated if you use the convenience closing function on the vehicle key to close the windows and the glass roof. <

## Troubleshooting

### The glass roof will not close

- The glass roof only works when the ignition is switched on. The glass roof can still be operated for a short time after the ignition has been switched off, provided the driver door or front passenger door are not opened.
- If it is not possible to close the glass roof electrically, it must be closed manually. The glass roof

cannot be closed manually without removing vehicle components. Go to a correspondingly qualified workshop. Volkswagen recommends using a Volkswagen dealership.

#### Touch panels react differently than expected

Moisture, dirt and grease can impede the functioning of the touch panels.

1. Always keep touch panels clean and dry.

## Steering wheel

### Adjusting the steering wheel position



**Fig. 75** Below the steering wheel in the steering column trim: lever for mechanical adjustment of the steering wheel position (illustration).



**Fig. 76** On the steering wheel: 9 o'clock and 3 o'clock position.

Adjust the steering wheel position **before** setting off and only when the vehicle is stationary → ⚠.

1. Push down the lever → Fig. 75 ①.
2. Adjust the steering wheel so that you can hold it with both hands at its outer edge at the 9 o'clock and 3 o'clock positions with your arms slightly bent → Fig. 76.
3. Push the lever up firmly until it is flush with the steering column trim → ⚠.

## WARNING

Incorrect use of the steering wheel position adjustment and incorrect adjustment of the steering wheel can cause serious or fatal injuries.

- After adjusting the steering wheel, always move the lever → Fig. 75 ① up firmly. This prevents the steering wheel from moving accidentally while the vehicle is in motion.
- Never adjust the steering wheel when the vehicle is in motion. If you determine that adjustment is necessary when driving, stop the vehicle safely and adjust the steering wheel to the correct position.
- The steering wheel must always point towards the chest and not towards the face. This ensures that the driver front airbag provides maximum protection in the event of an accident.
- While driving, always keep both hands on the outside of the steering wheel at the 9 o'clock and 3 o'clock positions → Fig. 76. This reduces the risk of injury if the driver front airbag is triggered.
- Never hold the steering wheel at the 12 o'clock position, or in any other manner, e.g. at the hub of the steering wheel. If the driver front airbag is triggered, you could receive severe injuries to the arms, hands and head.

# Seats and head restraints

## Front seats

### Introduction to the topic

The following section describes the options for adjusting the front seats. Always ensure that your sitting position is correct → page 43.

## WARNING

Always adjust the front seats to their correct position before any journey and ensure that all passengers have fastened their seat belts correctly.

- Push the front passenger seat as far back as possible.
- Adjust the driver seat so that there is at least 25 cm (approximately 10 inches) between the driver's rib cage and the hub of the steering wheel. Adjust the driver seat by moving it forwards or backwards so that you are able to press the pedals to the floor with your knees still slightly angled and the distance to the dash panel in the knee area is at least 10 cm (approximately 4 inches). If your build makes it impossible to fulfil this requirement then you must contact a correspondingly qualified workshop so they can make any necessary modifications. Volkswagen recommends using a Volkswagen dealership.
- Never travel with the backrest tilted far back. The further back the backrest is tilted, the greater the risk of injury caused by incorrect seat belt routing or an incorrect sitting position.
- Never travel with the backrest tilted far forwards. When a front airbag is triggered it could force the seat backrest backwards and injure vehicle occupants on the back seats.
- You should always sit upright with your back against the seat backrest with the front seats properly adjusted. Do not position any body part directly against or too close to where the airbags are fitted.

## WARNING

Incorrect adjustment of the seats can cause accidents and serious injuries.

- Adjust the seats only when the vehicle is stationary. The seats could change position unexpectedly if you attempt to reposition them while the vehicle is in motion so that you lose of control of the vehicle as a result. Furthermore, an incorrect sitting position is adopted while adjusting the seat.

- Adjust the height and angle of the front seats or move them forwards and backwards only when there is no-one in the adjustment range of the seats.
- The adjustment range of the seats must not be restricted by any items.
- Adjust the angle of the rear seats or move the seats forwards and backwards only when there is no-one in the adjustment range of the seats.
- The areas for adjusting and locking the seats must not be soiled.

### **⚠ WARNING**

Improper use of seat covers or protective covers may lead to the electrical seat controls being operated accidentally and the front seats moving unexpectedly while the vehicle is moving. You could lose control over the vehicle. This could result in serious injury and accidents. Furthermore, this may result in damage to the electrical components in the front seats.

- Never fit seat or protective covers on the electric controls.
- Do not fit seat covers or protective covers over the seats unless they have been expressly approved for use in the vehicle.

### **⚠ WARNING**

Any lighters in the vehicle could be damaged or accidentally lit. This could lead to serious burns and other injuries.

- Before adjusting the seats, always make sure that there is no cigarette lighter on or near the movable parts of the seat.

### **⚠ NOTICE**

Sharp edges can damage the seats.

- Do not touch the seats with sharp-edged objects. Sharp objects, such as zips, rivets on clothing or belts, may damage surfaces. Open Velcro fasteners may also cause damage.

## Mechanically adjusting the front seat

☞ Please refer to **⚠** and **⚠** at the start of the chapter on page 90.

The following section contains a description of all possible controls. The number of controls may vary depending on the version of the seat.

The controls are mirrored for the front passenger seat.

The seat may have a combination of mechanical and electrical controls.



Fig. 77 On the driver seat: controls (variant 1).

- ① Operate the lever to adjust the lumbar support.
- ② Take your weight off the backrest and turn the handwheel to adjust it.
- ③ Move the lever up or down, several times if necessary, to adjust the seat height.
- ④ Pull the lever to push the front seat forwards or backwards. The front seat must engage after you release the lever!



Fig. 78 On the driver seat: controls (variant 2).

- ① Take your weight off the backrest and turn the handwheel to adjust it.
- ② Move the lever up or down, several times if necessary, to adjust the seat height.
- ③ Push or pull the lever as often as necessary to adjust the angle of the seat cushion.
- ④ Raise the handle to slide the seat cushion forwards or backwards.
- ⑤ Pull the lever to push the front seat forwards or backwards. The front seat must engage after you release the lever!

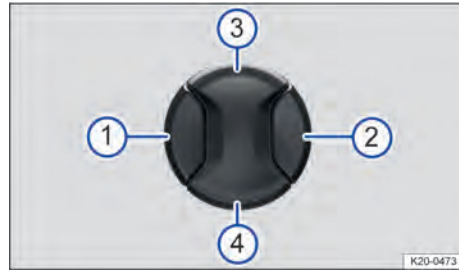

**Fig. 80** Switch on the driver seat: adjusting the lumbar support.

## Electrically adjusting the front seat

☞ Please refer to ▲ and ❶ at the start of the chapter on page 90.

The controls are mirrored for the front passenger seat.

The seat may have a combination of mechanical and electrical controls.

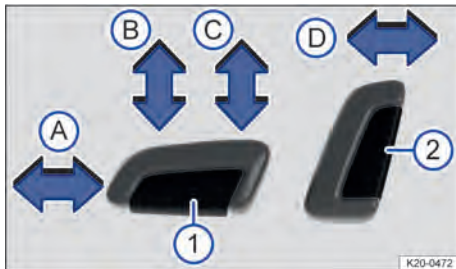

**Fig. 79** Switches on the driver seat: adjusting the front seat forwards or backwards, adjusting the backrest and the seat cushion height and tilt.

Pressing the switch in the direction of the arrow:

- ① A Slides the seat forwards or backwards.
- B Adjusts the angle of the seat cushion.
- C Raises or lowers the seat.
- ② D Adjusts the angle of the backrest.

Pressing the switch in the direction of the arrow:

- ① Adjust the curve of the lumbar support forwards.
- ② Adjust the curve of the lumbar support backwards.
- ③ Adjust the curve of the lumbar support upwards.
- ④ Moves the curve of the lumbar support down.

### ⚠ WARNING

Careless or unsupervised use of the electric front seats can result in severe injuries.

- The electrical front seat adjustment also works when the ignition is switched off. Never leave children or people requiring assistance alone in the vehicle.
- In the event of an emergency, stop electrical adjustment by pressing another switch.

### ❗ NOTICE

In order to avoid damage to the electrical components in the front seats, never kneel on the front seats or the seat cushion. Do not apply point loads to the backrest in any way.

❗ It may not be possible to adjust the seat electrically if the charge level of the 12-volt vehicle battery is too low.

❗ Starting the engine will interrupt the seat adjustment procedure.

## Folding the front passenger seat backrest forwards

📖 Please refer to ⚠️ and ❶ at the start of the chapter on page 90.

The front passenger seat backrest can be folded forwards to a horizontal position.

The front passenger front airbag must be switched off if any items are to be transported on the front passenger seat when folded forwards → page 55.

### Folding the front passenger seat backrest forwards



**Fig. 81** Front passenger seat: folding backrest forwards.

1. Remove any items from the front passenger seat cushion → ⚠️.
2. Lower the front passenger seat as far as possible.
3. Push the front passenger seat as far back as possible.
4. Push the head restraint all the way down.
5. Release the front passenger seat backrest in the direction of the arrow → Fig. 81 ❶.
6. Fold the front passenger seat backrest forwards in the direction of the arrow → Fig. 81 ❷ until it is horizontal.

When it is folded down, the front passenger seat backrest must engage securely into place.

### Folding back the front passenger seat backrest

When folding back, make sure that there are no items or body parts in the area of the hinges.

1. To fold back, release the front passenger seat backrest again → Fig. 81 ❶.
2. Fold back the front passenger seat backrest so that it is upright.

The front passenger seat backrest must engage securely into place in the vertical position.

### ⚠️ WARNING

Serious injuries could be caused if the front passenger seat backrest is folded forwards and backwards in an uncontrolled way and without taking due care.

- Fold the front passenger seat backrest forwards and backwards only when the vehicle is stationary.
- While folding the front passenger seat backrest forwards, always make sure that no people or animals are in its path.
- The front airbag must be switched off and the PASSENGER AIR BAG OFF indicator lamp must light up for as long as the front passenger seat backrest is folded forwards.
- When folding forwards and backwards, keep all hands, fingers, feet and other body parts away from the seat hinges and seat locking mechanism.
- Floor mats or other objects could get caught in the hinges on the front passenger seat backrest. This could cause the front passenger seat backrest to fail to engage securely when you return it to the upright position.
- When being folded back, the front passenger seat backrest must be securely locked in the upright position. If the front passenger seat backrest is not locked properly, it could move suddenly and cause serious injuries.

### ⚠️ WARNING

The open seat anchorages and hinges of the folded front passenger seat backrest can cause serious injuries in the event of a sudden braking manoeuvre or accident.

- Never transport persons or children on the front passenger seat when the front passenger seat backrest is folded forwards.
- If the front passenger seat backrest is folded forwards, you must use only the rear seat behind the driver seat. This also applies to children in child seats.

### ⚠️ WARNING

Items that are not secured, or are secured incorrectly, can cause serious injuries in the event of a sudden driving or braking manoeuvre or accident. This applies particularly if objects are struck when the airbag is triggered and then flung through the vehicle interior. To reduce the risk of accidents, please observe the following guidelines:

- Always stow all objects in the vehicle securely. Observe legal requirements when doing this.
- The front airbag must be switched off and the PASSENGER AIR BAG OFF  indicator lamp must light up for as long as the front passenger seat backrest is folded forwards.

## Rear seats

### Introduction to the topic

The following section describes the options for adjusting the rear seats. Always ensure that your sitting position is correct → page 43.

#### WARNING

Always adjust the rear seats to their correct position before starting any journey and make sure that all passengers have fastened their seat belts.

- The rear seat should be adjusted only when the vehicle is stationary as the rear seat could otherwise move unexpectedly while the vehicle is in motion. Furthermore, an incorrect sitting position is adopted while adjusting the seat.
- The risk of serious injury is increased for passengers on the rear seats if they are not sitting upright because the seat belts are incorrectly positioned.
- The rear seat should be adjusted only when there is no one in the adjustment area of the rear seats.

#### WARNING

Any lighters in the vehicle could be damaged or accidentally lit. This could lead to serious burns and other injuries.

- Before adjusting the seats, always make sure that there is no cigarette lighter on or near the movable parts of the seat.

#### WARNING

The centre armrest must always be folded up while the vehicle is in motion in order to reduce the risk of injury.

- The centre seat on the rear bench seat must never be used when the centre armrest is folded down – neither by adults nor children. An incorrect sitting position can cause severe injuries.
- Never transport an adult or child on the centre armrest.

#### NOTICE



- Items in the luggage compartment could cause damage when pushing the rear seat forwards or backwards.
- When the rear seat is moved forwards, objects could move into the space between the seat and luggage compartment floor. Remove any items or objects from this space before pushing the rear seat back.

#### NOTICE

Sharp edges can damage the seats.

- Do not touch the seats with sharp-edged objects. Sharp objects, such as zips, rivets on clothing or belts, may damage surfaces. Open Velcro fasteners may also cause damage.

### Adjusting the rear bench seat

 Please refer to  and  at the start of the chapter on page 94.

The rear bench seat is split asymmetrically. Each section can be adjusted separately.

#### Moving the rear bench seat in longitudinal direction



**Fig. 82** Under the seat cushion of the rear bench seat: adjusting lever.

1. Pull up the right-hand or left-hand lever in the direction of the arrow → Fig. 82 and move the corresponding element of the rear bench seat either forwards or backwards.
2. Release the lever and engage the rear bench seat element in position by pushing forwards and backwards gently.



### Adjusting the rear seat backrest

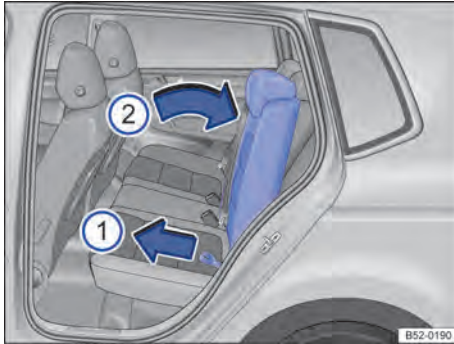

Fig. 83 Adjusting the rear seat backrest.

1. Push down on the right or left backrest with one hand and simultaneously pull on the corresponding loop with the other hand → Fig. 83 ①.
2. Adjust the rear seat backrest to the required position with your hand against the spring pressure → Fig. 83 ②.
3. Release the loop and engage the rear seat backrest in position by pushing forwards and backwards gently.

### Folding the backrest of the rear bench seat forwards and backwards

ⓘ Please refer to ⚠ and ① at the start of the chapter on page 94.

#### Folding the rear seat backrest forwards



Fig. 84 Rear bench seat: folding the rear seat backrest forwards and backwards.

1. Push the head restraint all the way down.
2. Slide the rear bench seat back as far as it will go.
3. Pull the loop → Fig. 84 forwards in the direction of the arrow while simultaneously supporting and folding the rear seat backrest forwards → ⚠.
4. Fold the rear seat backrest completely forward by hand until it locks in place.

#### Folding rear seat backrest forwards with the remote release button

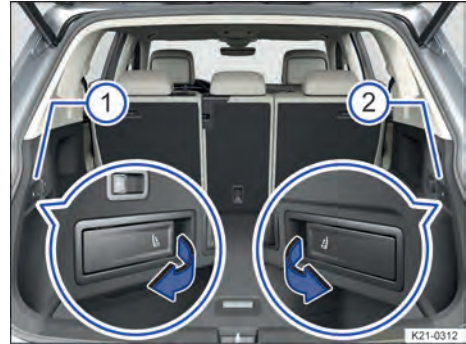

Fig. 85 In the luggage compartment: remote release lever for the left ① and the right ② parts of the rear seat backrest.

1. Push the head restraint all the way down.
2. Open the boot lid.
3. Pull the remote release lever → Fig. 85 for the section of the backrest that is to be folded forwards.  
The corresponding backrest section of the rear seat backrest is unlocked and can be folded forwards.
4. Close the boot lid if necessary.

#### Folding back the rear seat backrest

1. Use the loop to release the rear seat backrest.  
The rear seat backrest pops out of the catch.
2. Keep pulling on the loop while folding back the rear seat rest.
3. Make sure that the seat belt is not caught anywhere.
4. Fold back the rear seat backrest until it is securely engaged → ⚠.  
The rear seat backrest must always be securely engaged.
5. Adjust the rear seat backrest if necessary.
6. Adjust the head restraint if necessary.

## WARNING

Injuries can be caused if the rear seat backrest is folded forwards and backwards without due care and attention.

- While folding the rear seat backrest forward, always make sure that no people or animals are in its path.
- Never fold the rear seat backrest forwards or backwards while the vehicle is in motion.
- Ensure that the seat belt is not trapped or damaged when folding back the rear seat backrest.
- Always keep hands, fingers, feet or other body parts away from the swivel area when folding the rear seat backrest forwards and backwards.
- Ensure that each rear seat backrest engages securely, otherwise the seat belts for the rear seats will not offer maximum protection. This applies to the centre seat of the rear bench seat in particular. If a seat is occupied and the corresponding rear seat backrest has not clicked securely into place, the seat occupant and rear seat backrest may move forwards in the event of a sudden braking or driving manoeuvre or during accidents.
- If the rear seat backrest is folded forwards or is not engaged securely into place, passengers must not use these seats.

## NOTICE

Damage to the vehicle or to other objects could be caused if the rear seat backrest is folded forwards and backwards in an uncontrolled way or without due care.

- Before folding the rear seat backrests forwards, always adjust the front seats so that the rear head restraints or rear seat cushions do not collide with the front seats.
- Before folding down the rear seat backrest, always make sure that there are no objects located in its path.

## Head restraints

### Introduction to the topic

The following section describes the options for adjusting and removing the head restraints. Always ensure that your sitting position is correct → page 43.

Every seat is fitted with a head restraint. The head restraints are approved specifically for the respec-

tive seat and must not be installed at any other seat in the vehicle.

The rear centre head restraint (depending on vehicle equipment) is designed solely for use with the centre seat on the rear bench seat. Therefore you should not install this head restraint in any of the other positions.

There are notches in the rods of the head restraints which enable them to engage in different positions. Only correctly mounted head restraints can engage in the notches in the adjustment area. To prevent accidental removal of the head restraints after installation, stops are fitted at the top and bottom of the adjustment area.

### Correct head restraint adjustment

Adjust the head restraint so that its upper edge is at the same height as the top of the head, but not lower than eye level. Position the back of your head as close to the head restraint as possible.

In vehicles with head restraints that can be adjusted forwards and backwards, position the head restraints on the front seats as close as possible to the back of your head.

### Head restraint adjustment for shorter people

Push the head restraint all the way down, even if the head is then underneath the top edge of the head restraint. There may be a small gap between the head restraint and backrest in the lowest position.

### Head restraint adjustment for taller people

Push the head restraint up as far as it will go.

## WARNING



Driving without head restraints or with incorrectly adjusted head restraints increases the risk of severe or fatal injuries in the event of an accident or sudden driving or braking manoeuvre.

- If a seat is occupied, the head restraint for that seat must always be fitted and adjusted correctly.
- If a seat is occupied, adjust the head restraint corresponding to the size of the person sitting on the seat.
- Never adjust the head restraint when the vehicle is in motion.

## NOTICE

When removing or fitting head restraints, make sure that they do not hit the roof, the front seat backrest or other parts of the vehicle. This will prevent damage from occurring.

## Adjusting the head restraints

Please refer to  and  at the start of the chapter on page 96.





### Adjusting the height of the head restraint



**Fig. 86** Illustration: adjusting the front head restraint without longitudinal adjustment.

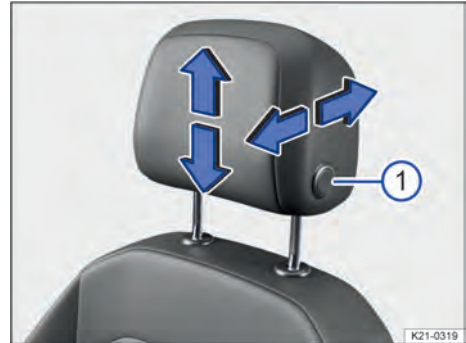

**Fig. 87** Illustration: adjusting the rear head restraint.

1. While pressing the   or   button if necessary, push the head restraint up or down in the direction of the arrows.

The head restraint must engage securely into position.

### Adjusting front head restraint in longitudinal direction





**Fig. 88** Illustration: adjusting front head restraint with longitudinal adjustment.

1. Push the head restraint forwards in the direction of the arrow or press and hold button  and push it backwards.

The head restraint must engage securely into position. 

## Removing and installing the head restraints

Please refer to  and  at the start of the chapter on page 96.

### Removing the front head restraints



**Fig. 89** Illustration: removing front head restraint.

1. If necessary, lower the head restraint.
2. To release the head restraint, feel for the recess in the marked area on the rear side and press it in the direction of the arrow .

3. Pull the head restraint out in the direction of the arrow → Fig. 89 ②.

#### Fitting the front head restraints

1. Position the head restraint correctly over the head restraint guides and then insert into the guides of the corresponding seat backrest.
2. Push the head restraint down until the guide pins click into place.
3. Adjust the head restraint so a correct sitting position can be assumed.

#### Removing the rear head restraints



Fig. 90 Illustration: removing rear head restraint.

1. If necessary, adjust the backrest so that the head restraint can be removed.
2. Push the head restraint all the way up.
3. Pull the head restraint out fully while pressing the button → Fig. 90 ①.

#### Fitting the rear head restraints

1. Release the rear seat backrest and fold the backrest forwards slightly.
2. Position the head restraint correctly over the head restraint guides and then insert into the guides of the corresponding seat backrest.
3. Press and hold the button → Fig. 90 ① and push down the head restraint.
4. Fold back the rear seat backrest and allow it to engage securely.
5. Adjust the head restraint so a correct sitting position can be assumed. <

## Seat functions

### Centre armrest

#### Front centre armrest



Fig. 91 Front centre armrest (illustration).

- To lift: pull the centre armrest up gradually in the direction of the arrow → Fig. 91.
- To lower: pull the centre armrest all the way up. Then lower the centre armrest.
- To move it backwards and forwards: push the centre armrest in the direction of the arrow → Fig. 91 all the way forwards or all the way backwards.

#### **⚠ WARNING**

When fully open or not completely closed, the front centre armrest can restrict the freedom of movement of the driver's arms and therefore cause accidents and serious injuries.

- Always keep stowage compartments closed while the vehicle is in motion.
- Never transport an adult or child on the centre armrest. An incorrect sitting position can cause serious injury.

## Rear centre armrest



Fig. 92 Rear fold-out centre armrest.

There may be a fold-out centre armrest in the backrest of the middle seat of the rear bench seat.

- To *fold it down*: pull the loop on the centre armrest in the direction of the arrow → Fig. 92.
- To *fold it back*: fold the centre armrest upwards in the opposite direction of the arrow → Fig. 92 and push it into the backrest as far as it will go.

Do not use the middle seat on the rear bench seat to transport passengers when the centre armrest is folded down.

### WARNING

The rear centre armrest must always be folded up while the vehicle is in motion in order to reduce the risk of injury.

- The centre seat on the rear bench seat must never be used when the centre armrest is folded down – neither by adults nor children. An incorrect sitting position can cause severe injuries.

## Memory function

### Memory buttons



Fig. 93 On the outside of the driver seat: memory buttons.

The memory buttons can be used to store and recall settings for the driver seat and the exterior mirrors.

### Storing driver seat and exterior mirror settings for driving forwards

1. Switch on the electronic parking brake.
2. Put the gearbox into neutral.
3. Switch on the ignition.
4. Adjust the driver seat and exterior mirrors.
5. Press the **SET** → Fig. 93 button for longer than 10 seconds.
6. Within approximately 10 seconds, press the memory button you wish to use.

An acoustic signal confirms that the settings have been stored.

### Storing the front passenger exterior mirror settings for reversing

1. Switch on the electronic parking brake.
2. Put the gearbox into neutral.
3. Switch on the ignition.
4. Press the desired memory button → Fig. 93.
5. Select reverse gear.
6. Adjust the exterior mirror on the front passenger side so that you have a good view of the kerb area, for example.

The settings for the mirror position will be saved automatically and assigned to the vehicle key that was used to unlock the vehicle.

### Accessing driver seat and exterior mirror settings

1. When the vehicle is stationary, the ignition is switched off and one vehicle door is open, briefly press the corresponding memory button.

After around 10 minutes, the stored positions can *no longer* be adjusted automatically. The adjustment process is cancelled if one of the memory buttons is pressed again.

**Or:** with the ignition switched on or the vehicle door closed, press and hold the corresponding memory button until the stored position has been reached.

The front passenger exterior mirror will leave the position saved for reversing automatically if the vehicle drives forwards at a speed of at least around 15 km/h (around 10 mph) or if you turn the rotary knob for the exterior mirror out of the **R** position and into another position.

-  If you open the driver door later than approximately 10 minutes after unlocking the vehicle,

the driver seat and exterior mirrors are not automatically adjusted.

### Convenient entry function

When the driver door is opened, the driver seat automatically moves to a position which makes it easy to enter and exit the vehicle.

The driver seat moves back to its original position automatically as soon as the driver door is closed and the ignition is switched on.

You can switch the convenient entry function on and off in the Infotainment system.

### Personalisation

You can save and access your individual seat setting in a user account via the personalisation function → page 41.

After switching off the ignition and locking the vehicle, the driver seat and exterior mirror settings are stored in the user account.

The driver seat and exterior mirror settings are restored after the vehicle is unlocked and the driver door is opened.

The seat responds to selecting or changing a user account as follows:

- *Vehicle stationary or moving no faster than around 5 km/h (3 mph):* seat is moved. You can cancel the movement at any time by tapping the appropriate function button in the Infotainment system or by pressing a button on the driver seat.
- *Vehicle moving faster than around 5 km/h (around 3 mph):* seat is not moved. All other settings are made.

 Some settings can be stored in the user accounts of the personalisation function and therefore change automatically when the user account changes → page 41.

### WARNING

Incorrect use of the seat functions can cause serious injuries.

- Always assume the correct sitting position before the start of the journey and maintain this position during the journey. This also applies to all passengers.
- Adjust the memory function only when the vehicle is stationary.
- Keep hands, fingers, feet and other body parts away from seat's moving parts and adjustment range.

## Memory function with the vehicle key

### Memory buttons

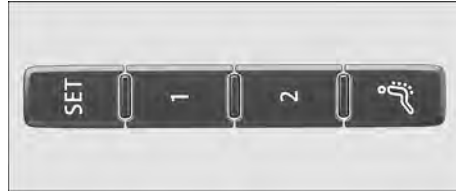

**Fig. 94** On the outside of the driver seat: memory buttons.

The memory buttons can be used to store and recall settings for the driver seat and the exterior mirrors.

### Storing driver seat and exterior mirror settings for driving forwards

1. Switch on the electronic parking brake.
2. Put the gearbox into neutral.
3. Switch on the ignition.
4. Adjust the driver seat and exterior mirrors.
5. Press the **SET** → Fig. 94 button for longer than 1 second.
6. Within approximately 10 seconds, press the memory button you wish to use.

An acoustic signal confirms that the settings have been stored.

### Storing the front passenger exterior mirror settings for reversing

1. Switch on the electronic parking brake.
2. Put the gearbox into neutral.
3. Switch on the ignition.
4. Press the desired memory button.
5. Select reverse gear.
6. Adjust the exterior mirror on the front passenger side so that you have a good view of the kerb area, for example.

The settings for the mirror position will be saved automatically and assigned to the vehicle key that was used to unlock the vehicle.

### Accessing driver seat and exterior mirror settings

1. When the vehicle is stationary, the ignition is switched off and one vehicle door is open, briefly press the corresponding memory button.

After around 10 minutes, the stored positions can *no longer* be adjusted automatically. The

adjustment process is cancelled if one of the memory buttons is pressed again.

**Or:** with the ignition switched on or the vehicle door closed, press and hold the corresponding memory button until the stored position has been reached.

The front passenger exterior mirror will leave the position saved for reversing automatically if the vehicle drives forwards at a speed of at least around 15 km/h (around 10 mph) or if you turn the rotary knob for the exterior mirror out of the **R** position and into another position.

### Activating the memory function in the vehicle key

The memory function of the vehicle keys is deactivated when the keys are supplied from the factory, and must first be activated.

1. Switch off the ignition.
2. Open the driver door.
3. Depending on version, press the **(MENU)** button or function button of the Infotainment system → page 37.
4. Depending on version, tap the **(Vehicle)** function button.
5. Tap the **(Settings)** function button.
6. Tap the **(Seats)** function button.
7. Tap the **(Vehicle key activated)** function button.  
An activated checkbox is displayed .
8. Press any memory button → Fig. 94 on the seat and keep it pressed until the end of the activation process.
9. Keeping the memory button pressed down, press the unlocking button **(🔓)** in the vehicle key within 3 seconds.

An acoustic signal confirms activation.

 In order to activate the memory function of the vehicle key, it is first necessary to assign a stored seat position to both memory buttons.

 If you use two vehicle keys, each key can be assigned to only one of the two memory buttons. It is not possible to assign both vehicle keys to one memory button.

### Deactivating the memory function in the vehicle key

Prerequisite: a memory position is stored.

1. Open the driver door.
2. Press the **(SET)** → Fig. 94 button and then keep it pressed till the end of the deactivation process.
3. Keeping the memory button pressed down, press the unlocking button **(🔓)** in the vehicle key within 10 seconds.

An acoustic signal confirms deactivation.

### Assigning driver seat and exterior mirror settings to a vehicle key

1. Activate the memory function in the vehicle key.
2. Unlock the vehicle using the same vehicle key.
3. Adjust exterior mirror and driver seat.
4. To save the settings, lock the vehicle with the locking button **(🔒)** on the vehicle key.

After the settings are saved, the driver seat and exterior mirrors always assume the saved position automatically when the **(🔓)** button in the vehicle key or the keyless locking and starting system Keyless Access is used to unlock the vehicle and open the driver door.

If two or more people use a vehicle, we recommend that each person always uses their "own" vehicle key.

In order for settings to be saved automatically to the personal vehicle key, the vehicle key used to lock the vehicle must be the same vehicle key that was used to unlock the vehicle.

### Initialising the memory function

The memory system has to be initialised if, for example, the driver seat is changed.

The initialisation process deletes all of the saved settings and assignments in the memory function. The memory buttons can then be reprogrammed and resynchronised with a vehicle key.

1. Open the driver door but do not get into the vehicle.
2. Adjust the seat from the outside.
3. Adjust the angle of the backrest to as far forwards as possible.
4. Release the switch for adjusting the backrest angle and press it again until an acoustic signal sounds.

### WARNING

Incorrect use of the seat functions can cause serious injuries.

- Always assume the correct sitting position before the start of the journey and maintain this position during the journey. This also applies to all passengers.
- Adjust the memory function only when the vehicle is stationary.
- Keep hands, fingers, feet and other body parts away from seat's moving parts and adjustment range.

**i** If you open the driver door later than approximately 10 minutes after unlocking the vehicle, the driver seat and exterior mirrors are not automatically adjusted.

## Message function

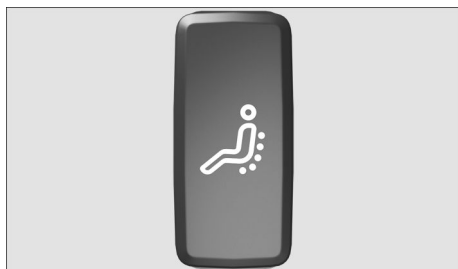

**Fig. 95** In the lower area of the driver seat: button for massage function.

When the massage function is switched on, the lumbar support moves and massages the lumbar region.

The curvature of the lumbar support can be individually adjusted during operation by repeatedly pressing the corresponding switch → page 92.

### Switching the massage function on or off

To switch on, press the  button in the seat control panel. To switch off, press the  button again.

The massage function switches itself off automatically after approximately 10 minutes.

## **WARNING**

Incorrect use of the seat functions can cause serious injuries.

- Always assume the correct sitting position before the start of the journey and maintain this position during the journey. This also applies to all passengers.
- Switch the massage function on and off only when the vehicle is stationary.
- Keep hands, fingers, feet and other body parts away from seat's moving parts and adjustment range.

# Lights

## Vehicle lighting

### Switching turn signals on and off



**Fig. 96** On the left-hand side of the steering column: turn signal and main beam lever.

- A** Right turn signal ➔
- B** Left turn signal ➜

### Switching turn signals on and off

1. Switch on the ignition.
2. Move the turn signal and main beam lever from the centre position to the desired position → Fig. 96:
3. To switch off the turn signal, move the turn signal and main beam lever to the basic position.

Go to a suitably qualified workshop and have the vehicle checked if the acoustic signal does not sound when a turn signal is switched on. Volkswagen recommends using a Volkswagen dealership.

### Convenience turn signal

To operate the convenience turn signal, push the turn signal and main beam lever up or down to the point where you meet resistance and then release the lever. The turn signal flashes three times.

To cancel the convenience turn signal, immediately move the lever in the opposite direction up to the pressure point and then release it.

◁ The convenience turn signal can be activated and deactivated in the vehicle settings in the Infotainment system → page 37.

## **WARNING**

Incorrect use of turn signals, a failure to use turn signals, or forgetting to switch off a turn signal can confuse other road users. This can lead to accidents and serious injuries.



- Always activate the turn signal in good time when changing lanes and performing overtaking or turning manoeuvres.
- Always switch off the turn signal once the lane change or overtaking or turning manoeuvre has been completed.

 The hazard warning lights also work when the ignition is switched off → page 65.

 Some settings can be stored in the user accounts of the personalisation function and therefore change when the user account changes → page 41.

## Switching lights on and off





**Fig. 97** Next to the steering wheel: light switch (one variant).

### Switching lights on

1. Switch on the ignition.
2. Turn the light switch to the corresponding position → Fig. 97:

**0** The daytime running lights are switched on.

**AUTO** Automatic lighting control: dipped beam is switched on or off depending on the brightness level and the weather conditions →  → page 109.

 The side lights and daytime running lights are switched on. The symbol in the light switch lights up green.

 Dipped beam is switched on.

### Switching off the lights

1. Switch off the ignition.
2. Turn the light switch to the corresponding position:

**0** The lights are switched off.

**AUTO** The orientation lighting can be switched on → page 108.

 The side lights or continuous parking light on both sides of the vehicle are switched on → page 107. The symbol in the light switch lights up green.

 Dipped beam is switched off.

*Vehicles with ignition lock:* the side lights will stay on while the vehicle key is in the ignition lock.

*Vehicles with starter button:* the side lights will stay on while the driver door is closed.

### Daytime running lights

The daytime running lights (dependent on equipment level) can increase the visibility of your vehicle in traffic during the day.

The daytime running lights are switched on every time the ignition is switched on when the light switch is in position **0**,  or **AUTO** (if brightness is detected).

The daytime running lights cannot be switched on or off manually.

### WARNING

Accidents and serious injuries can occur if roads are not sufficiently illuminated and other road users have difficulty seeing the vehicle, or cannot see it at all.

- The light assistance systems only provide support; the driver is responsible for making sure the vehicle lights are switched on correctly.
- Always switch on dipped beam when it is dark or raining and in poor visibility.
- Regularly check that all lights and turn signals are working properly.

### WARNING

The side lights or daytime running lights are not bright enough to illuminate the road ahead and to ensure that other road users are able to see you.

- Always switch on dipped beam when it is dark or raining and in poor visibility.
- The tail lights will not be switched on with the daytime running lights. If the tail lights are not switched on, the vehicle may not be visible to other road users if it is dark, raining, or if visibility is poor.

### WARNING

The automatic lighting control function **AUTO** switches the dipped beam headlights on and off only when there is a change in the level of brightness.



- Switch the dipped beam on manually if required by the weather conditions, e.g. in the event of fog.

 When reverse gear is engaged, the cornering light on both sides of the vehicle switches on to provide better illumination of the surrounding area when manoeuvring.

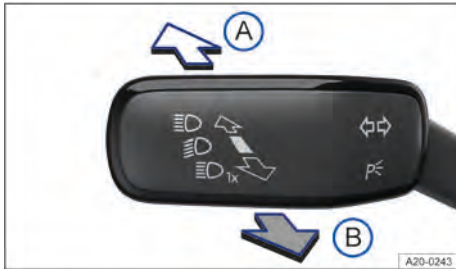
## Switching main beam on and off



**Fig. 98** On the left-hand side of the steering column: turn signal and main beam lever.

- (A)  Switch on the main beam.
- (B)  Operate the headlight flasher or switch off the main beam.

The blue indicator lamp  lights up in the instrument cluster when the main beam or headlight flasher are switched on.

### Switching on the main beam

1. Switch on the ignition and dipped beam.
2. Push the turn signal and main beam lever forwards from the centre position → [Fig. 98](#).

### Switching off the main beam

1. Pull the turn signal and main beam lever to the rear from the centre position → [Fig. 98](#).

### Switching the headlight flasher on and off

1. Pull the turn signal and main beam lever to the rear from the centre position and hold it → [Fig. 98](#).  
To switch it off, release the turn signal and main beam lever.

### Main-beam control

Depending on the vehicle equipment level, advanced main-beam control may also be available → page 104 , → page 105.

## WARNING

Incorrect use of the main beam headlights can lead to accidents and serious injuries as the main beam headlights can distract and dazzle other road users.



## Main-beam control

Main-beam control automatically dips the headlights when oncoming vehicles and vehicles driving in front are detected. Main-beam control normally also recognises illuminated areas such as towns and deactivates main beam while driving through them.

Within the limits of the system, main-beam control automatically switches the main beam on or off depending on the environmental and traffic conditions and on the driving speed → .

### (A) Switching on main-beam control

1. Switch on the ignition and automatic lighting control **AUTO**.
2. Push the turn signal and main beam lever forwards from its basic position.

When the main-beam control is switched on, the  indicator lamp in the instrument cluster display lights up. When main-beam control is active, the blue indicator lamp  lights up in the instrument cluster.

### Switching off main-beam control

1. Switch off automatic lighting control **AUTO**.

**Or:** main-beam control switched on and active: pull back the turn signal and main beam lever.

**Or:** main-beam control switched on and not active: tap the turn signal and main beam lever forwards to switch on the manual main beam. Pull back the turn signal and main beam lever to switch off the manual main beam if necessary.

**Or:** switch off the ignition.

### System limits

The main beam must be manually switched off under the following conditions, as it is not switched off by the main beam control in time or at all:

- In badly lit towns that the system cannot recognise as towns.
- In poorly lit streets where there are highly reflective signs.
- Other road users with insufficient lighting facilities, such as pedestrians, cyclists.

- In tight bends, on steep hill crests or in dips in the road or when oncoming traffic is half-hidden.
- With oncoming traffic on streets with a central barrier where the driver can see clearly over the central barrier e.g. truck drivers.
- In fog, snow or heavy rain.
- In conditions where dust or sand has been blown up.
- Damage to the windscreen in the camera's field of vision.
- If the field of view of the camera is covered by condensation, dirt, a sticker, snow or ice.
- If the camera is faulty or the power supply is interrupted.

### WARNING

Do not let the extra convenience afforded by main-beam control tempt you into taking any risks when driving. The system is not a substitute for the full concentration of the driver.

- Always check the lighting yourself and adjust it to suit the light, visibility and traffic conditions.
- The main-beam control may not be able to recognise all driving situations correctly and may not work properly in certain situations.
- If the camera's field of view is dirty, covered or damaged, the function of the main-beam control may be impaired. This also applies if changes are made to the vehicle's lighting system, for example if additional headlights are fitted.

### NOTICE

Please observe the following points in order to avoid impairing the proper function of the system:

- Clean the camera's field of view at regular intervals, and keep it free from snow and ice.
- Do not cover the camera's field of view.
- Check the area of the windscreen which is in the camera's field of view for damage at regular intervals.

## Advanced main-beam control

Advanced main-beam control provides maximum illumination for the road and the edges of the road. At the same time, it prevents vehicles in front or oncoming vehicles from being dazzled. The system uses a camera to detect other self-illuminated road users and their distance from your vehicle and deactivates areas within the light distribution in a target-



ted manner. If the system can no longer prevent other road users from being dazzled, main beam is switched off completely. Advanced main-beam control normally also recognises illuminated areas such as towns and deactivates main beam while driving through them.

Within the limits of the system, main-beam control automatically switches the main beam on or off depending on the surroundings and traffic conditions and on the driving speed → .

Advanced main-beam control can be activated and deactivated in the vehicle settings in the Infotainment system → page 37.

### Switching on advanced main-beam control

1. Switch on the ignition and automatic lighting control **AUTO**.
2. Push the turn signal and main beam lever forwards from its basic position.

When the main-beam control is switched on, the  indicator lamp in the instrument cluster display lights up. When main-beam control is active, the blue indicator lamp  lights up in the instrument cluster.

### Switching off advanced main-beam control

1. Switch off automatic lighting control **AUTO**.

**Or:** main-beam control switched on and active: pull back the turn signal and main beam lever.

**Or:** main-beam control switched on and not active: tap the turn signal and main beam lever forwards to switch on the manual main beam. Pull back the turn signal and main beam lever to switch off the manual main beam if necessary.

**Or:** switch off the ignition.

### System limits

The main beam must be manually switched off under the following conditions, as it is not switched off by the main beam control in time or at all:

- In badly lit towns that the system cannot recognise as towns.
- In poorly lit streets where there are highly reflective signs.
- Other road users with insufficient lighting facilities, such as pedestrians, cyclists.
- In tight bends, on steep hill crests or in dips in the road or when oncoming traffic is half-hidden.
- With oncoming traffic on streets with a central barrier where the driver can see clearly over the central barrier e.g. truck drivers.
- In fog, snow or heavy rain.

- In conditions where dust or sand has been blown up.
- Damage to the windscreen in the camera's field of vision.
- If the field of view of the camera is covered by condensation, dirt, a sticker, snow or ice.
- If the camera is faulty or the power supply is interrupted.

### WARNING

Do not let the extra convenience afforded by main-beam control tempt you into taking any risks when driving. The system is not a substitute for the full concentration of the driver.

- Always check the lighting yourself and adjust it to suit the light, visibility and traffic conditions.
- The main-beam control may not be able to recognise all driving situations correctly and may not work properly in certain situations.
- If the camera's field of view is dirty, covered or damaged, the function of the main-beam control may be impaired. This also applies if changes are made to the vehicle's lighting system, for example if additional headlights are fitted.

### NOTICE

Please observe the following points in order to avoid impairing the proper function of the system:

- Clean the camera's field of view at regular intervals, and keep it free from snow and ice.
- Do not cover the camera's field of view.
- Check the area of the windscreen which is in the camera's field of view for damage at regular intervals.

## Dynamic cornering light

The dynamic cornering light permits optimum illumination of the road.



The dynamic cornering light only works when the automatic lighting control **AUTO** is switched on and at speeds above approximately 10 km/h (6 mph).



 Some settings can be stored in the user accounts of the personalisation function and therefore change when the user account changes → page 41.

## Switching poor weather light on and off

The poor weather light allows the driver to improve illumination of the road in poor visibility conditions.

The poor weather light can be switched on when the ignition is switched on and the light switch is in the positions **AUTO** and dipped beam  → page 103:

- To switch on the **poor weather light** : pull the light switch out to the first notch. The indicator lamp  in the light switch lights up green.
- To switch the poor weather light off, press the light switch or move it to position **0**.

 If the poor weather light is switched on with **AUTO** the automatic headlight control turned on, the dipped beam headlight will also be switched on irrespective of the current ambient conditions. 

## Troubleshooting

### Turn signal indicator lamp

The indicator lamp flashes green.

If a turn signal on the vehicle has failed, the indicator lamp will start flashing twice as fast.

1. Check the lighting and change the appropriate bulb as required → page 294.
2. If the fault persists, go to a correspondingly qualified workshop. Volkswagen recommends using a Volkswagen dealership.

### Trailer turn signal indicator lamp

The indicator lamp flashes green.

The indicator lamp goes out if a trailer turn signal or all trailer lights stop working.

1. Check the lighting and change the appropriate bulb as required → page 294.
2. If the fault persists, go to a correspondingly qualified workshop. Volkswagen recommends using a Volkswagen dealership.

### Exterior drive lighting not working

The indicator lamp lights up yellow.

Vehicle lighting not working partially or completely.

1. Check the lighting and change the appropriate bulb as required → page 294.

- If the fault persists, go to a correspondingly qualified workshop. Volkswagen recommends using a Volkswagen dealership.

### Fault in rain and light sensor

The indicator lamp lights up yellow.

In the light switch position **AUTO**, the vehicle lighting is not switched on or off automatically.

- Switch the ignition off and on.
- If the fault persists, go to a correspondingly qualified workshop. Volkswagen recommends using a Volkswagen dealership.

### Dynamic cornering light

The dynamic cornering light does not work when travel mode is activated.

The swivel behaviour of the lights can be affected by the selected driving profile.

A corresponding display appears in the instrument cluster if there is a dynamic cornering light fault. Go to a correspondingly qualified workshop. Volkswagen recommends using a Volkswagen dealership.

### Advanced main-beam control

Advanced main-beam control will respond in the same way as the *normal* main-beam control and switch main beam on or off automatically in the following situations:

- Dynamic cornering light is deactivated.
- Travel mode is activated → page 110.

## Fog lights

### Switching the rear fog light on and off

The rear fog light can be switched on when the ignition is switched on and when the light switch is in the **AUTO** and dipped beam  positions → page 103:

#### Switching on the rear fog light

- Pull out the light switch.

The indicator lamp  lights up yellow in the instrument cluster.

#### Switching off the rear fog light

- Press in the light switch or turn to **0** position.

 If the rear fog light is switched on while the automatic headlight control is switched on **AUTO**, the dipped beam headlights will also be

switched on irrespective of the prevailing light conditions outside.

 In vehicles with a factory-fitted towing bracket: the vehicle's rear fog light is not switched on if a trailer with rear fog light is electrically connected to the vehicle.

## Side lights

### Side lights

When the side lights  are switched on, both headlights light up with side lights together with parts of the tail light clusters, the number plate light and the buttons in the centre console and dash panel. The daytime running lights also switch on when the ignition is switched on.

If the vehicle is not locked from outside when the ignition is switched off, the continuous parking light on both sides of the vehicle switches on automatically after around 10 minutes to reduce 12-volt vehicle battery discharge → page 107.

### Switching parking lights on and off



**Fig. 99** On the left-hand side of the steering column: turn signal and main beam lever.

- Right-hand parking light **P** is switched on.
- Left-hand parking light **P** is switched on.

#### Switching on parking light on one side of the vehicle

When the parking lights are switched on, the headlight with side light and parts of the tail light cluster on the corresponding side of the vehicle light up.

- Switch off the ignition.
- Move the turn signal and main beam lever from the centre position to the desired position → Fig. 99.

### Continuous parking light on both sides of the vehicle

Both headlights light up with side lights as well as parts of the tail light clusters if continuous parking light on both sides of the vehicle is switched on:

1. Switch on the side lights ☞.
2. Switch off the ignition.
3. Lock the vehicle from outside.

### Automatic switch-off of side lights and parking lights

The vehicle will detect a weak 12-volt vehicle battery and switch off the side lights or parking lights in good time so that the engine can still be started – however, this will occur after 2 hours at the earliest.

If the battery capacity is not sufficient for the side lights or parking light to remain switched on for 2 hours, the 12-volt vehicle battery can be discharged to such an extent that it is no longer possible to start the engine → ⚠.

#### ⚠ WARNING

Accidents and serious injuries can occur if the vehicle is parked without sufficient illumination, as other road users might have difficulty seeing the vehicle, or may not see it at all.

- Always park the vehicle safely and with sufficient lighting.
- Observe any applicable country-specific legal requirements.
- If the vehicle lighting is required for several hours, switch on the right or left parking light if possible. The activation duration of the one-sided parking light is generally double that of the continuous parking light on both sides.

### Coming Home and Leaving Home function (orientation lighting)

The Coming Home and Leaving Home function lights up the area immediately surrounding the vehicle when you get in or out of the vehicle in darkness.

Depending on equipment, the vehicle can have an automatic or manual Coming Home function:

- **Automatic Coming Home function:** the Coming Home and Leaving Home functions are controlled automatically by a rain and light sensor.
- **Manual Coming Home function:** the Coming Home function is switched on manually.

The Leaving Home function is controlled automatically by a rain and light sensor.

The switch-off delay can be set and the function activated or deactivated in the vehicle settings in the Infotainment system → page 37.

### Switching on the automatic Coming Home function

1. Switch off the ignition.

The Coming Home lights are switched on when the light switch is in the **AUTO** position and the rain and light sensor detects *darkness*.

The *switch-off delay* starts when the last vehicle door or the boot lid is closed.

### Switching on the manual Coming Home function

1. Switch off the ignition.
2. Operate headlight flasher.

The Coming Home lighting is switched on when the driver door is opened. The *switch-off delay* starts when the last vehicle door or the boot lid has been closed.

### Switching off the Coming Home function

1. Automatically after the set switch-off delay has elapsed.

**Or:** automatically if a vehicle door or the boot lid is opened approximately 30 seconds after switch-on.

**Or:** switch off the lights.

**Or:** switch on the ignition.

### Switching on the Leaving Home function

1. Unlock the vehicle when the automatic headlights function **AUTO** is switched on and the rain/light sensor detects that it is *dark*.

### Switching off the Leaving Home function

1. Automatically after the switch-off delay.

**Or:** lock the vehicle.

**Or:** switch off the lights.

**Or:** switch on the ignition.

 Some settings can be stored in the user accounts of the personalisation function and therefore change when the user account changes → page 41.

## Light functions

### Cornering light

When dipped beam is switched on, a cornering light is switched on when turning slowly or driving around very tight bends.

 When reverse gear is engaged, the cornering light on both sides of the vehicle switches on to provide better illumination of the surrounding area when manoeuvring.

### Automatic lighting control

When the automatic lighting control **AUTO** is switched on, the vehicle lighting and the instrument and switch lighting will switch on under the following conditions:

- The light sensor has detected darkness.
- The windscreen wipers have been switched on for an extended period.

**AUTO** When the lights are switched on, the indicator lamp lights up yellow → page 103.

The automatic lighting control is merely an aid and will not always be able to detect all driving situations.

In vehicles with a corresponding equipment level, the switch-on time of the automatic headlights can be set in the vehicle settings in the Infotainment system → page 37.

### Headlight range control



**Fig. 100** In the Infotainment system: touch slider for manual headlight range control.

-  Touch slider for headlight range control.

Headlight range control can be used to adjust the light cone of the dipped beam headlights to the vehicle load level. This gives the driver the best visibility

possible and means that oncoming traffic will not be dazzled → .

With some equipment levels, the headlight range can be adjusted using the touch slider in the Infotainment system.

#### Manual headlight range control

Adjustment using the touch slider in the Infotainment system:

1. Press the **(MENU)** button or function button.
2. Tap the **(Vehicle)** and **(Settings)** function buttons to open the **Vehicle settings** menu.
3. Tap the **(Lights)** function button to open the **Light settings** menu.
4. Tap the **(Headlight range control)** → **Fig. 100** function button **1**.
5. Move the touch slider to the required position (typical vehicle load level).

#### Adjustment value in Infotainment system when standard running gear is installed:

- 0** Front seats occupied and luggage compartment empty.
- 2** All seats occupied and luggage compartment empty.
- 5** All seats occupied and luggage compartment fully loaded.
- 6** Only the driver seat occupied and luggage compartment fully loaded.

#### Adjustment value in Infotainment system when sports running gear is installed:

- 0** Front seats occupied and luggage compartment empty.
- 2** All seats occupied and luggage compartment empty.
- 3** All seats occupied and luggage compartment fully loaded.
- 4** Only the driver seat occupied and luggage compartment fully loaded.

#### Dynamic headlight range control

The headlight range cannot be adjusted manually if the vehicle has dynamic headlight range control. The headlight range is automatically adapted to suit the vehicle load level as soon as the headlights are switched on → .

#### WARNING

Heavy objects in the vehicle can cause the headlights to dazzle and distract other road users. This can lead to accidents and serious injuries.

- Always adapt the light cone to the load level of the vehicle to avoid dazzling other road users.

## WARNING

Failure or malfunction in the dynamic headlight range control can cause the headlights to dazzle or distract other road users. This can lead to accidents and serious injuries.

- Have the headlight range control checked by a suitably qualified workshop as soon as possible. Volkswagen recommends using a Volkswagen dealership.

## Switching over headlights for driving abroad (travel mode)

If you have to drive a right-hand drive vehicle in a left-hand drive country, or vice versa, the asymmetric dipped beam headlights may dazzle oncoming traffic. Some headlight versions must therefore be switched over when you travel to these countries.



In vehicles with advanced main-beam control, the alignment of the headlights can be adjusted in the Infotainment system in the **(Vehicle settings)** menu → page 37.

The function of the dynamic cornering light and advanced main-beam control is deactivated once travel mode is activated. The main beam is then only switched on and off automatically.

 Travel mode may only be used for a short period. Please contact a suitably qualified workshop if permanent alteration is required. Volkswagen recommends using a Volkswagen dealership.

## Acoustic warnings if lights are not switched off

When the ignition has been switched off and the driver door is opened, acoustic warnings will sound under the following conditions:

- If the parking light is switched on.
- If the side lights  are switched on.
- If the rear fog light  is switched on.

When the orientation lighting is switched on, no acoustic warning will be given as a reminder that a light is still switched on when leaving the vehicle → page 108.

## Interior lighting

### Instrument and switch lighting

The brightness of the instrument and switch lighting and the basic brightness level of the Head-up Display can be adjusted in the vehicle settings in the Infotainment system → page 37.

The brightness setting is automatically adjusted to the changing ambient light conditions in the vehicle.

When the automatic lighting control **AUTO** is switched on, a sensor will switch the dipped beam and the lighting in the instruments and switches on and off automatically depending on the ambient brightness level.

 When the lights are switched off and the ignition switched on, the instrument and switch lighting (needles and scales) is switched on. As the ambient light becomes lower, the lighting of the scales is automatically reduced and may be switched off entirely. This function is intended to remind the driver to switch on the dipped beam in good time, i.e. when driving through tunnels.

### Interior and reading lights, background lighting

Press the corresponding button:



Switches the rear interior lights on and off.



The interior lights are switched on automatically when the vehicle is unlocked, a door is opened or the vehicle key is removed from the ignition.



Switch the reading light on or off.

### Glove box and luggage compartment lights

A light will be switched on or off when the glove box or boot lid is opened or closed.

### Background lighting

Depending on the equipment level, the background lighting provides indirect light in the various areas of the vehicle interior.

Other areas can also be illuminated, e.g. the footwell.

Some background lighting functions, e.g. the brightness, can be adjusted in the vehicle settings in the Infotainment system → page 37.



**i** The lights go out when the vehicle is locked or after a delay of a few minutes when the vehicle key is removed from the ignition lock. This prevents the 12-volt battery from discharging.

**i** Some settings can be stored in the user accounts of the personalisation function and therefore change when the user account changes → page 41.

## Vision

## Wipers

### Operating the wiper lever

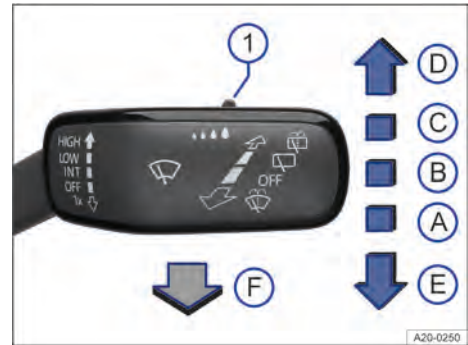

**Fig. 101** On the right-hand side of the steering column: operating the windscreen wipers.

Move the wiper lever to the desired position → **i**:

- A** **OFF** Wipers switched off.
- B** **INT** Interval wipe for the windscreen or rain sensor mode. The interval wipe for the windscreen depends on the speed of the vehicle. The wipers will wipe more frequently as the vehicle moves faster.
- C** **LOW** Slow wiping.
- D** **HIGH** Fast wiping.
- E** **M** Flick wipe – short wiping. Push and hold the lever down for longer to wipe more quickly.
- F** **M** Automatic wipe/wash for cleaning the windscreen with the lever pulled. The Climatronic will switch to air recirculation mode for approximately 30 seconds to prevent the smell of the windscreen washer fluid from entering the vehicle interior.
- 1** **M** Switch for interval stages (vehicles without rain and light sensor) or adjusting the sensitivity of the rain and light sensor.



**Fig. 102** On the right-hand side of the steering column: operating the rear window wiper.

Move the wiper lever to the desired position → ⓘ:

- ⓘ Intermittent wiping for the rear window. The wiper will wipe the window approximately every six seconds.
- ⓘ Automatic wipe/wash for cleaning the rear window with the lever pushed.

The wipers function only when the ignition is switched on and the bonnet or boot lid are closed.

### WARNING

Without adequate anti-freeze, the washer fluid may freeze onto the windscreen and obscure your view.

- At winter temperatures, use the window washer system only when adequate anti-freeze has been added.
- Never use the windscreen washer system at winter temperatures before the windscreen has been heated by the ventilation system, for example. This could lead to the anti-freeze mixture freezing on the windscreen and restrict the driver's vision.

### WARNING

Worn or dirty windscreen wiper blades reduce visibility and increase the risk of accidents and severe injuries.

- Always change wiper blades if they are damaged or worn and no longer clean the windscreen properly → page 293.

### NOTICE

Before setting off and before switching on the ignition, always check the following to avoid damage to the windows, wiper blades and wiper motor:

- The wiper lever is located in the basic position.
- Snow and ice have been removed from the wiper blades and windows.

- Wiper blades that have become frozen onto the glass have been carefully loosened. Volkswagen recommends using a de-icer spray for this.

### NOTICE

Do not switch on the wipers when the window is dry. Using the wipers when the window is dry can damage the glass.

When switched on, the wipers will temporarily be switched to the next setting down when the vehicle is stationary.

Some settings can be stored in the user accounts of the personalisation function and therefore change automatically when the user account changes → page 41.

If the vehicle is parked during cold weather, the service position of the windscreen wiper may be helpful in order to be able to release the wiper blades better from the windscreen → page 292.

## Wiper function

### Automatic activation of the rear window wiper

The rear window wiper is switched on automatically if the front windscreen wipers are switched on and reverse gear is engaged. Automatic activation when reverse gear is engaged can be activated and deactivated in the vehicle settings in the Infotainment system → page 37.

### Heated washer jets

The heating defrosts frozen washer jets. The heating output is automatically regulated when the ignition is switched on, depending on the ambient temperature. Only the washer jets are heated and not the hoses carrying washer fluid.

## Rain and light sensor



**Fig. 103** On the right of the steering column: wiper lever.

- ① Switch for setting the sensitivity of the rain and light sensor.
- A The rain and light sensor is deactivated.
- B The rain and light sensor is activated, automatic wipe when necessary.

When the rain and light sensor is activated, it automatically controls the frequency of the wiper intervals, depending on the intensity of the rain.

### Activating and deactivating the rain and light sensor

1. Push the lever into the required position → Fig. 103.

The automatic wipe function can be activated and deactivated in the vehicle settings in the Infotainment system → page 37.

If the automatic wipe function is deactivated in the Infotainment system, the intervals are set at fixed levels.

### Adjusting the sensitivity of the rain and light sensor

The sensitivity of the rain and light sensor can be adjusted manually using the switch in the wiper lever → Fig. 103 ①, → ⚠.

- Switch to the right – high sensitivity.
- Switch to the left – low sensitivity.

### ⚠ WARNING

The rain and light sensor cannot always detect all precipitation sufficiently and activate the wipers.

- If necessary, switch on the wipers manually if the water on the windscreen restricts the field of vision.

**Info** Some settings can be stored in the user accounts of the personalisation function and

therefore change automatically when the user account changes → page 41. <

## Troubleshooting

### 🔧 Washer fluid level too low

The indicator lamp lights up yellow.

1. Fill up the washer fluid reservoir as soon as possible → page 313.

### 🔧 Fault in wipers

The indicator lamp lights up yellow.

The wipers do not wipe.

1. Switch the ignition off and on.
2. If the fault persists, go to a correspondingly qualified workshop. Volkswagen recommends using a Volkswagen dealership.

### 🔧 Fault in rain and light sensor

The indicator lamp lights up yellow.

The wipers are not switched on automatically if it rains during rain and light sensor operation.

1. Switch the ignition off and on.
2. If the fault persists, go to a correspondingly qualified workshop. Volkswagen recommends using a Volkswagen dealership.

### Changes in the response of the rain and light sensor

Possible causes for faults and misinterpretations relating to the sensitive surface of the rain and light sensor → page 8 include:

- **Damaged wiper blades:** a film of water or smears caused by damaged wiper blades can increase the time the wipers are switched on, can shorten the length of the intervals between wipes or cause the wipers to run quickly and continuously.
- **Insects:** insects hitting the windscreen surface can cause the wipers to be activated.
- **Salt deposits:** in winter, salt deposits can cause the wipers to continue to wipe the windscreen when it is almost dry.
- **Soiling:** dry dust, wax, windscreen coatings (lotus effect), or detergent deposits (from an automatic car wash) can cause the rain and light sensor to become less sensitive and react too slowly, or prevent it from reacting at all. Clean the sensitive surface of the rain and light sensor at regular intervals and inspect the wiper blades for damage → page 357.

– **Crack in the windscreen:** a wipe cycle will be triggered if the rain and light sensor is switched on when the windscreen is impacted by a stone. The rain and light sensor will then register the reduction in sensitivity of the surfaces and adjust accordingly. The size of the crack can affect the way in which the rain and light sensor activates the wipers.

 The wipers will try to wipe away any obstacles that are on the window. The wipers will stop moving if the obstacle blocks their path. Remove the obstacle and switch the wipers back on again. <

## Mirrors

### General safety notes

The driver can use the exterior mirrors and interior mirror to observe the traffic behind and adjust the driving style accordingly.

For safety reasons, it is important that the driver positions the exterior and interior mirrors correctly before starting a journey.

Looking in the exterior mirrors and the interior mirror does not allow the driver to see the entire area around the side and rear of the vehicle. The area that cannot be seen is known as the blind spot. There may be objects and other road users in the blind spot.

#### WARNING

Adjusting the exterior and interior mirrors while driving may cause the driver to become distracted. This can lead to accidents and serious injuries.

- Adjust the exterior mirrors and interior mirror only when the vehicle is stationary.
- When parking, changing lane, or performing an overtaking or turning manoeuvre, always pay careful attention to the area around the vehicle as objects and other road users may be located in the blind spot.
- Always ensure that the mirrors are positioned correctly and that the rear view is not restricted by ice, snow, condensation or any other objects.

#### WARNING

If you estimate the distance from traffic behind you incorrectly, you can cause accidents and serious injuries.

- Curved mirrors (convex or aspheric) enlarge the field of vision and can make objects in the mir-

ror seem smaller and further away than they actually are.

- Using curved mirrors to estimate the distance from other vehicles behind you when changing lanes can provide inaccurate results and can lead to accidents and severe injuries.
- Whenever possible, use the interior mirror to check the exact distance between your vehicle and following traffic or other objects.
- Ensure that you have a good view to the rear of the vehicle.

#### WARNING

Automatic anti-dazzle mirrors contain an electrolyte fluid which could leak if the mirror is broken.

- The leaking electrolyte fluid can cause irritation to the skin, eyes and respiratory organs, especially in people who suffer from asthma or similar illnesses. Immediately ensure that there is a sufficient supply of fresh air and get out of the vehicle. If this is not possible, open all of the windows and doors.
- If your eyes or skin come into contact with the electrolyte fluid, wash the affected location immediately with plenty of water for at least 15 minutes and consult a doctor.
- If your shoes or clothing come into contact with the electrolyte fluid, wash them immediately with plenty of water for at least 15 minutes. Clean shoes and clothes thoroughly before wearing them again.
- If you have swallowed electrolyte fluid, rinse your mouth immediately with plenty of water for at least 15 minutes. Do not induce vomiting unless instructed to do so by a doctor. Seek medical assistance immediately.

#### NOTICE

If the glass of an automatic anti-dazzle mirror is broken, electrolyte fluid can leak from the mirror. This fluid attacks plastic surfaces.

- Remove any fluid that has leaked out as soon as possible, e.g. with a wet sponge. <

## Interior mirror



**Fig. 104** On the windscreen: automatic anti-dazzle interior mirror.

- ① Front sensor.
- ② Rear sensor.



**Fig. 105** On the windscreen: manual anti-dazzle interior mirror.

### Automatic anti-dazzle interior mirror

When the ignition is switched on, the sensors measure the incident light from the rear → Fig. 104 ① and from the front ②.

The interior mirror dims *automatically* depending on the values measured.

If the incident light on the sensors is hindered or interrupted, e.g. by a sun blind or other hanging objects, the automatic anti-dazzle interior mirror will not function or will not function correctly. Mobile navigation devices attached to the windscreen or near the interior automatic anti-dazzle interior mirror can also influence the sensors → ⚠.

The automatic anti-dazzle function will be deactivated in some situations, e.g. when reverse gear is engaged.

### Manual anti-dazzle interior mirror

- Basic position: the lever on the lower part of the mirror is pointing forwards towards the windscreen.
- Pull the lever back to select the anti-dazzle function → Fig. 105.

### ⚠ WARNING

The illuminated display from a portable navigation device can lead to functional impairment of the interior automatic anti-dazzle mirror and cause accidents or serious injuries.

- You may not be able to precisely determine the distance from vehicles travelling behind you or from other objects if the automatic anti-dazzle function is impaired.

## Exterior mirrors

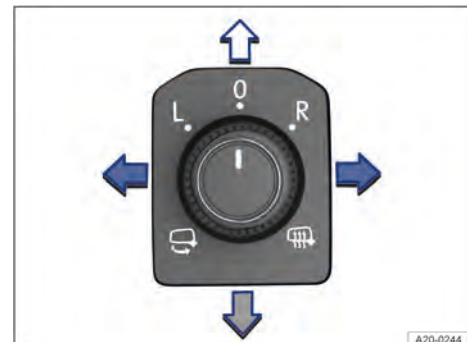

**Fig. 106** In the driver door: rotary knob for the exterior mirrors.

The exterior mirror functions for left-hand drive vehicles are described below. Position **L** corresponds to the exterior mirror on the driver side and position **R** to the exterior mirror on the front passenger side. These instructions are mirrored for right-hand drive vehicles.

### Adjusting the exterior mirrors

1. Switch on the ignition.
2. Turn the rotary knob in the driver door to the desired symbol → Fig. 106.
3. Press the rotary knob to the front, rear, right or left in the direction of the arrow to adjust the exterior mirror.



Fold exterior mirrors into the body electrically → .



Switch on the exterior mirror heating. The exterior mirror heating heats only at ambient temperatures below around +20°C (around +68°F) and initially with the highest setting. Heating takes place dependent on the ambient temperature after around two minutes.

Adjust the left-hand exterior mirror.

**L**  
**R**  
**O**

Adjust the right-hand exterior mirror.

Neutral position. The exterior mirror cannot be adjusted and all functions are switched off.

### Activating the exterior mirror functions

The following exterior mirror functions must be activated once in the vehicle settings in the Infotainment system → page 37.

#### Synchronous mirror adjustment

The synchronous mirror adjustment function simultaneously adjusts the right exterior mirror when the left exterior mirror is adjusted.

1. Turn the rotary knob to position **L**.
2. Adjust the left-hand exterior mirror. The right-hand exterior mirror will be adjusted at the same time (synchronous adjustment).
3. To correct the adjustment of the right exterior mirror if necessary, turn the rotary knob to position **R** and adjust the right exterior mirror.

#### Folding in the exterior mirrors while parking

The exterior mirrors fold in or out automatically when the vehicle is locked or unlocked from the outside. In order for this to happen, the rotary knob must be in position , **L**, **R** or **O**.

The exterior mirrors remain folded in if the rotary knob for the electrically adjustable exterior mirrors is in the position .

#### Storing front passenger exterior mirror settings for reversing

1. Unlock the vehicle with the vehicle key to which the settings should be assigned.
2. Switch on the electronic parking brake.

3. Switch on the ignition.
4. Put the gearbox into neutral.
5. Select reverse gear.
6. Adjust the exterior mirror on the front passenger side so that you have a good view of the kerb area, for example.
7. Put the gearbox into neutral.
8. Switch off the ignition.

The settings for the mirror position will be saved and assigned to the vehicle key.

#### Activating the front passenger exterior mirror setting for reversing

1. Turn the rotary knob for the exterior mirrors to the position for adjusting the front passenger exterior mirror.
2. With the ignition switched on, select reverse gear. The front passenger exterior mirror will now adjust itself to the stored position.

The front passenger exterior mirror will move out of the position saved for reversing when the vehicle is driven forwards faster than approximately 15 km/h (around 9 mph) or when the rotary knob is turned to another position.

#### WARNING

Injuries can be sustained if you do not take care when folding the exterior mirrors in and out.

- Fold the exterior mirrors in or out only when there is no obstruction in the path of the mirror.
- Always ensure that no fingers are trapped between the exterior mirror and the mirror base when the exterior mirrors are moved.

#### NOTICE

Exterior mirrors may be damaged if they are not folded in when driving through a car wash.

- Always fold in the exterior mirrors.
- Do not fold electrically folding exterior mirrors in or out manually as this can damage the electric motor.



The exterior mirror heating should be switched off when it is no longer needed. Fuel is otherwise wasted.



In the event of a fault, the electric exterior mirrors can be adjusted by hand by pressing on the outer edge of the mirror.



Some settings can be stored in the user accounts of the personalisation function and

therefore change automatically when the user account changes → page 41.

## Protection from the sun

### Sun visors

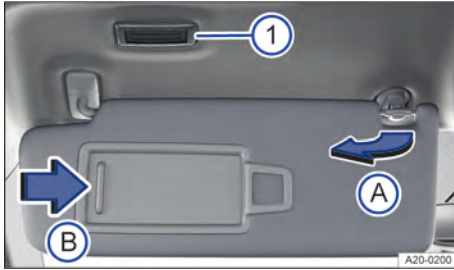

Fig. 107 In the front headliner: sun visor.

- ① Light.
- Ⓐ Pull out of the holder.
- Ⓑ Slide the cover open.

#### Adjustment options for the driver and front passenger sun visors:

- Folded down over the windscreen.
- Pulled out of the bracket and swung over towards the door → Fig. 107 Ⓐ.

#### Illuminated vanity mirror

There is a vanity mirror behind a cover on the inside of the sun visor. When you open the cover → Fig. 107 Ⓑ, the lamp → Fig. 107 ① lights up.

### ⚠ WARNING

Driving with the sun visors folded down and the sun blinds pulled out can reduce your view of the road.

- Sun visors should always be folded away and sun blinds should always be retracted if they are not being used.

**i** In certain circumstances, the lamp above the sun visor will go out automatically after a few minutes. This prevents the 12-volt battery from discharging.

### Sun blind in the glass roof



Fig. 108 In the roof: button for controlling the sun blind.

- ① Button for opening the sun blind.
- ② Button for closing the sun blind.

The electric sun blind works when the ignition is switched on.

When the glass roof is fully tilted, the sun blind is automatically moved to a ventilation position. The sun blind remains in the ventilation position even when the glass roof is closed.

The buttons → Fig. 108 ① and ② have two positions. In the first position, the sun blind can be completely or partially opened or closed.

In the second position, the sun blind automatically moves to the final position when the button is operated briefly. Press the button again to stop the one-tap function.

#### Opening the sun blind

1. Push the button ① to the first position.

*One-tap function:* Push the button ① briefly to the second position.

2. Press the button ① again to stop the one-tap function for opening.

#### Closing the sun blind

1. Push the button ② to the first position.

*One-tap function:* Push the button ② briefly to the second position.

2. Press the button ② again to stop the one-tap function for closing.

The sun blind can be operated several minutes after the ignition has been switched off, provided that the driver door and front passenger door are not opened.

### Roll-back function for the sun blind

The roll-back function can reduce the risk of injuries when closing the sun blind → ⚠. The glass roof or the sun blind will open again immediately if the sun blind is unable to close because it is stiff or obstructed.

1. Check to see why the sun blind has not closed.
2. Try to close the sun blind again.

The sun blind will open again immediately if it is still unable to close because it is stiff or obstructed. After opening, the sun blind can be closed again within a short period of time without the roll-back function.

3. If the sun blind still cannot be closed, close it without the roll-back function.

### Closing the sun blind without the roll-back function

1. Within approximately 5 seconds of the roll-back function being triggered, press and hold the button → Fig. 108 ② until the sun blind has closed completely.

The sun blind will now close without the roll-back function.

2. Please go to a correspondingly qualified workshop if the sun blind still cannot be closed. Volkswagen recommends using a Volkswagen dealership.

### ⚠ WARNING

Closing the sun blind without the roll-back function can cause serious injuries.

- Always take care when closing the sun blind.
- Ensure that nobody obstructs the path of the sun blind, especially if the roll-back function is not active when it is closed.
- The roll-back function does not prevent fingers or other body parts from being pressed against the roof frame and sustaining injury.

 When the glass roof is open, the electric sun blind can be closed only up to the front edge of the glass roof. ◀

## Windscreen with windscreen heating



Fig. 109 Next to the mirror base: communication window.

Heat-insulating glass windscreens may have an infrared-reflecting coating and can be heated wirelessly with some equipment levels. To ensure that any radio equipment purchased as an accessory, e.g. a toll system, functions properly, there are uncoated areas (communication windows) on either side of the interior mirror → Fig. 109.

The uncoated areas should not be covered either from the outside or the inside, nor should any stickers be applied to this area as this could cause a fault. ◀



# Heating and air conditioning system

## Climatronic

### Overview of the Climatronic

#### Automatic air conditioning system

The Climatronic is an automatic air conditioning system that heats, cools and dehumidifies the air. Automatic mode enables the Climatronic to control the air temperature, air distribution and air volume automatically.

The air conditioning system will work most effectively if the vehicle interior is kept closed. Opening

the windows and glass roof to provide fresh air may accelerate cooling down the vehicle if high temperatures have built up in the vehicle interior.

Some functions of the air conditioning system and an air conditioning block for the rear seats depend on the vehicle equipment.



Fig. 110 In the upper part of the centre console: Climatronic air conditioning block.

#### Display of active functions

Lit up LEDs on the air conditioning block indicate that the function is switched on.

Yellow function buttons display an activated function in the air conditioning menu on the Infotainment system → page 120.

#### **⚠ WARNING**

Poor visibility through the door windows, windscreen and rear window increases the risk of collisions and accidents which can cause serious injuries.

- Keep all door windows, the windscreen and the rear window free from ice, snow and condensation to maintain perfect visibility.

- Adjust the heating, air conditioning and rear window heating to prevent condensation from forming on the windows.
- Only set off once all windows are clear.
- Use air recirculation mode for a short period only. Condensation could otherwise form very quickly on the windows, greatly reducing visibility.
- Switch off the air recirculation mode when it is no longer required.

**i** Some settings can be stored in the user accounts of the personalisation function and therefore change when the user account changes → page 41.

## Air conditioning system menu in the Infotainment system

### At the air conditioning block

**MENU** Open the air conditioning menu in the Infotainment system.

The air conditioning menu in the Infotainment system is only available with Climatronic. Some functions depend on the vehicle equipment.

In the air conditioning menu you will find, for example, the functions for temperature control → page 121 and air distribution → page 122.

The upper area of the screen shows current air conditioning settings, e.g. the air conditioning profile for automatic mode.

The lower area of the screen shows function buttons for frequently used air conditioning functions.

### Air conditioning system operating conditions

The air conditioning system operating conditions are highlighted in colour:

 Cooling.

 Heating.

### Air conditioning settings submenu

 Open the Air conditioning settings submenu.



- Switches automatic air recirculation mode on → page 123.
- Allow automatic auxiliary heating measure → page 125.
- Switch on automatic windscreen heating → page 125.

## Switching the Climatronic on and off

### In the air conditioning menu or at the air conditioning block

**OFF** Switching off the Climatronic.

 Adjust the blower speed.

 On vehicles with an auxiliary heater and auxiliary ventilation, the button for the instant heating function of the auxiliary heater  instead of

the **OFF** button can be located on the air conditioning block.

1. To switch on the Climatronic, increase the fan speed.
2. To switch off the Climatronic, swipe to the left on the touch slider for fan speed. <

## Climatronic automatic mode

### In the air conditioning menu or at the air conditioning block

**AUTO** The set air temperature is kept constant. The volume of air and air distribution are controlled automatically. Automatic mode switches off when the blower speed is adjusted manually.

### Selecting air conditioning profile

The blower speed in automatic mode can be controlled via the climate profiles.

1. Open the air conditioning menu.
2. Tap **AUTO**.
3. To select an air conditioning profile, tap on the top edge of the screen .
4. Select the desired air conditioning profile in the pop-up window. <

## Air Care

### In the air conditioning menu: bottom edge of the screen

< The enhanced air filter with activated carbon in the Air Care Climatronic can reduce the amount of pollutants and also allergens that enter the vehicle interior.

When Air Care is switched on, the air conditioning system's air recirculation mode is maximised as far as is permitted by the risk of window fogging depending on the interior humidity and outside temperature. The air recirculation mode is automatically regulated and features continuous adjustment in order to prevent the vehicle occupants becoming tired.

### Switching Air Care on and off

1. Open the air conditioning menu.
2. Tap Air Care.
3. Tap Active. <

# Manual air conditioning system

## Manual air conditioning system overview

The manual air conditioning system heats, cools and dehumidifies the air.

The air conditioning system will work most effectively if the vehicle interior is kept closed. Opening the windows and glass roof to provide fresh air may

accelerate cooling down the vehicle if high temperatures have built up in the vehicle interior.

Some functions of the air conditioning system depend on the vehicle equipment level.



Fig. 111 In the upper section of the centre console: air conditioning block for the manual air conditioning system.

### Display of active functions

Lit up LEDs on the air conditioning block indicate that the function is switched on.

### ⚠ WARNING

Poor visibility through the door windows, windscreen and rear window increases the risk of collisions and accidents which can cause serious injuries.

- Keep all door windows, the windscreen and the rear window free from ice, snow and condensation to maintain perfect visibility.

- Adjust the heating, air conditioning and rear window heating to prevent condensation from forming on the windows.
- Only set off once all windows are clear.
- Use air recirculation mode for a short period only. Condensation could otherwise form very quickly on the windows, greatly reducing visibility.
- Switch off the air recirculation mode when it is no longer required.

## Switching the manual air conditioning system on and off

### At the air conditioning block

**OFF** Switch off the air conditioning system.



Adjust the blower speed.



On vehicles with an auxiliary heater and auxiliary ventilation, the button for the instant heating function of the auxiliary heater (🔥) instead of the **OFF** button can be located on the air conditioning block.

1. To switch on the manual air conditioning system, turn the centre rotary knob clockwise.
2. To switch off the manual air conditioning system, turn the centre rotary knob anticlockwise as far as it will go.

## Temperature control



**In the air conditioning menu or at the air conditioning block**

- Select temperature.

**A/C** The air is cooled and dehumidified in cooling mode.

**SYNC** Adopt temperature settings of driver side for all seats.

### Setting the temperature on the Climatronic air conditioning block

1. To adjust the Climatronic temperature to +22°C (+72°F), tap and hold the touch slider centrally between  and .

**Or:** to set a different temperature, swipe the touch slider to the left or right.



Climatronic shows the temperature settings.

### Setting the temperature on the air conditioning block of the manual air conditioning system

1. turn the left rotary knob.

### Maximum cooling output and heating output

1. Tap and hold  or  on the touch slider of the Climatronic.



**Or:** turn the left rotary knob of the manual air conditioning system as far as it will go to  or .



### In the Infotainment system: Auxiliary heater menu



Open the Auxiliary heater menu in the Infotainment system → page 126.

### Setting the temperature for the rear row of seats

1. Open the air conditioning menu in the Infotainment system.
2. Tap the function button for the rear row of seats.
3. Tap function button  or .

**Or:** tap  or  on the air conditioning block for the rear seats.

The temperatures set for the rear row of seats are shown on the displays of the air conditioning block for the rear seats.



If  is activated in the Infotainment system, the rear air conditioning block cannot be operated.

## Air distribution and fan speed

### Vents

There are vents in the vehicle in the following locations:

- Driver side.
- Front passenger side.
- Front centre console.
- Rear centre console.

### NOTICE

Food, medicine and other items that are sensitive to heat or cold could be either damaged or rendered useless by the air flowing out of the vents.

- Never leave food, medicines or other temperature-sensitive objects in front of the vents.

### Glove box with cooling function

When the air vent is open, fresh air flows into the glove box. When the air conditioning system is cooling the vehicle interior, the cooled air can also be routed into the glove box.

### Air distribution functions in the air conditioning menu or at the air conditioning block



Adjust the blower speed.



- Top arrow: direct air onto the windscreen.
- Middle arrow: direct air towards upper body.
- Bottom arrow: direct air into the footwell.



Direct air towards upper body.



Direct air into the footwell.



Guide air to the upper body and the footwell.



Guide air to the windscreen and the footwell.



Direct air onto the windscreen.

## Defrost function

### Switching the defrost function on and off

 The defrost function of Climatronic clears the windscreen of ice and condensation. The air is dehumidified and the blower is set to a high speed.



The defrost function of the manual air conditioning system clears the windscreen of ice and condensation.

The air must be dehumidified when the defrost function is switched on. For this reason, you cannot switch on air recirculation mode or switch off cooling mode when the defrost function is switched on.

## Air recirculation mode

### Switching air recirculation mode on and off at the air conditioning menu or the air conditioning block



When air recirculation mode is switched on, no fresh air enters the vehicle interior.

1. Press  in the air conditioning block.

### Automatic air recirculation mode of Climatronic

Automatic air recirculation mode supports you within the system limits by temporarily switching the fresh air supply on or off if the fresh air entering the vehicle is of poor quality. The system cannot detect unpleasant odours.

1. Open the air conditioning menu in the Infotainment system.
2. Switch automatic air recirculation mode on or off via  ► **Automatic recirculation mode**.

### When does air recirculation mode switch off?

Air recirculation mode switches off in the following situations → :

- When the defrost function is switched on.
- If a sensor detects that condensation might form on the vehicle's windows.

### WARNING

Stale air can quickly make the driver tired and negatively affect their concentration which may cause collisions, accidents and serious injuries.

- Never use air recirculation mode for an extended period as no fresh air will enter the vehicle interior.
- Use air recirculation mode for a short period only. Condensation could otherwise form very quickly on the windows, greatly reducing visibility.
- Switch off the air recirculation mode when it is no longer required.

### NOTICE

In vehicles with an air conditioning system, do not smoke when the air recirculation mode is switched on. The smoke can leave a residue on the evaporator of the cooling system and the enhanced air filter with activated carbon, producing a lasting unpleasant odour.



**Climatronic:** When reversing the vehicle or when the wash and wipe system is being used, the air recirculation mode will switch on to prevent odours from entering the vehicle interior.



**Manual air conditioning system:** If the outside temperature is very high, brief activation of air recirculation mode helps to cool the vehicle interior more quickly.

## Seat heating

### Switching the seat heating on and off in the air conditioning menu or on the air conditioning block

When the engine is running, the front seats and the outer rear seats can be electrically heated in three settings.



Switch the seat heating on and off.







If you start the engine again within approximately 10 minutes, the most recent driver seat temperature setting is switched on automatically.

### Heating levels of the seat heating

The seat heating operating conditions are highlighted in colour:

- All three LEDs light up at the highest temperature setting.

### Operating the seat heating

1. To switch on the seat heating with the highest temperature setting, press the  or  button in the air conditioning block.
2. To set the temperature setting, press the  or  button repeatedly.
3. To switch the seat heating off, press the  or  button repeatedly until no LEDs lit.

### When should the seat heating not be switched on?

Do not switch on the seat heating if one of the following conditions applies:

- A person with reduced sensitivity to pain or temperature is sitting on the seat → .
- The seat is not occupied.

- The seat is fitted with a protective cover.
- A child seat is installed on the seat.
- The seat cushion is damp or wet.
- The temperature in the vehicle interior or the outside temperature is above +25°C (+77 °F).

### WARNING

Magnetic fields are produced during operation of the seat heating. In isolated cases, these magnetic fields can affect active medical implants, e.g. pacemakers.

- Wearers of an active medical implant should consult their doctor or the implant manufacturer before operating the seat heating.
- Also make the other vehicle occupants aware of this if necessary.

### WARNING

Anyone with reduced sensitivity to pain or temperature due to medication, paralysis or chronic illness (e.g. diabetes) could sustain burns on the back, buttocks and legs when using the seat heating. These burns may take a long time to heal or may never heal fully. Please consult a doctor if you have questions about your own state of health.

- Anyone with reduced sensitivity to pain or temperature should never use the seat heating.

### WARNING

Wet seat covers can cause a malfunctions in the seat heating and increase the risk of burns.

- Ensure that the seat cushion is dry before using the seat heating.
- Do not sit on the seat in damp or wet clothing.
- Do not place any damp or wet objects or items of clothing on the seat.
- Do not spill any liquids on the seat.

### NOTICE

- To avoid damaging the heating elements, do not kneel on the seats and do not apply sharp pressure at a single point to the seat cushion and backrest.
- Liquids, sharp objects and insulating materials, such as a protective cover or child seat, may damage the seat heating.
- If odours develop, switch off the seat heating immediately and have it checked by a suitably qualified workshop. Volkswagen recommends using a Volkswagen dealership.

- If the original seat covers are replaced with another material, the seat heating can overheat or the seat heating function may be restricted.



To save fuel, switch off the seat heating as soon as possible.



## Steering wheel heating

### Switching the steering wheel heating on and off on the multifunction steering wheel





Switch the steering wheel heating on and off.

The steering wheel heating functions only when the engine is running.

### Temperature settings of the steering wheel heating



When you switch on the steering wheel heating, the current temperature setting is continuously shown as a bar display in the instrument cluster. All three bars are filled at the highest temperature setting.

### Operating the heated steering wheel

1. Press the  button to switch on the steering wheel heating at the highest temperature setting.
2. To adjust the temperature setting, press the  button repeatedly.
3. To switch off the steering wheel heating, press the  button repeatedly until the bar display in the instrument cluster display goes out.

The most recent temperature setting is switched on automatically if you switch on the engine again within approximately 10 minutes.

### Storing the temperature setting

1. Switch on the steering wheel heating and set the desired temperature setting.
2. To store the current temperature setting, press and hold the  button for around 1 second.  
The temperature setting is not stored and the steering wheel heating is switched off.
3. To switch the steering wheel heating back on again with the last stored temperature setting, press and hold the  button for around 1 second.

### Steering wheel heating switches off automatically

The steering wheel heating switches itself off automatically if one of the following conditions is met:

- The power consumption is too high.

- There is a fault in the steering wheel heating system.

The rear window heating switches off automatically after around 10 minutes at the latest.

### NOTICE

Do not apply stickers over the heating elements from the inside to prevent damage to the rear window heating.



To save fuel, switch off the rear window heating as soon as possible.

## Windscreen heating

### Switching the windscreen heating on and off



*Manual air conditioning system:* Switch the windscreen heating on and off in the Vehicle settings menu → page 37.

*Climatronic:* Switch the windscreen heating on and off in the air conditioning menu.

The windscreen heating will only work when the engine is running.

The windscreen heating switches itself off depending on the outside temperature or after around 8 minutes at the latest.

### Automatic windscreen heating

The windscreen heating is switched on automatically if there is a risk of condensation forming on a window.

1. Open the air conditioning menu in the Infotainment system.
2. Switch the automatic windscreen heating on or off with  ► Automatic windscreen heating.



Automatic windscreen heating is also active when the air conditioning system is switched off.

### Windscreen heating using the defrost function

The windscreen heating will be switched on when the defrost function is switched on and a sensor detects that condensation may form on the windscreen.

### Windscreen heating switches off automatically

The windscreen heating switches itself off automatically if one of the following conditions is met:

- The power consumption is too high.
- There is a fault in the air conditioning system.
- The specified time has elapsed.

## Supplementary heating function

### Switching the supplementary heating function on and off

The supplementary heating function is available depending on the vehicle equipment. An additional heater can help to warm up the vehicle interior more quickly.

1. Open the air conditioning menu in the Infotainment system.
2. Tap .
3. Tap Automatic supplementary heater.

The heating unit is switched on automatically depending on the outside temperature and switches off again automatically after a short time.

### Vehicles with auxiliary heater (depending on equipment)

When the engine has been started, the auxiliary heater can continue operation as a supplementary heater. The following conditions must be met for this:

- The Automatic supplementary heater function is switched on in the air conditioning menu.
- The outside temperature is lower than +5°C (+41°F).

The supplementary heating function is switched off automatically after a short time.

## Rear window heating

### Switching the rear window heating on and off in the air conditioning menu or on the air conditioning block



Switch rear window heating on and off with running engine.

# Auxiliary heater and auxiliary ventilation

## Introduction to the topic

The auxiliary heater and auxiliary ventilation systems allow the vehicle interior to be heated in winter and ventilated in summer. The auxiliary heater allows ice, condensation or a thin covering of snow to be cleared from the windscreen. The auxiliary heater is supplied with fuel from the vehicle fuel tank and can be operated when the vehicle is stationary with the ignition switched off. The auxiliary ventilation system is supplied with power by the 12-volt vehicle battery.

### Exhaust system of the auxiliary heater

The emissions generated by the auxiliary heater are removed via an exhaust pipe underneath the vehicle. The exhaust pipe must not be blocked by snow, mud or any objects.

#### WARNING

The emissions from the auxiliary heater contain carbon monoxide which is an odourless and colourless poisonous gas. Carbon monoxide can cause people to lose consciousness. It can also cause death.

- Never switch on the auxiliary heater and leave the auxiliary heater running if the vehicle is located in enclosed or unventilated spaces.
- Never program the auxiliary heater so that it is switched on and runs in unventilated or enclosed spaces.

#### WARNING

Parts of the auxiliary heater's exhaust system become very hot. This can cause fires.



- Park the vehicle so that no part of the exhaust system can come into contact with any inflammable material underneath the vehicle, e.g. dry grass.

#### NOTICE

Food, medicine and other items that are sensitive to heat or cold could be either damaged or rendered useless by the air flowing out of the vents.

- Never leave food, medicines or other temperature-sensitive objects in front of the vents.

## Switching the auxiliary heater and auxiliary ventilation on and off





 Please refer to  and  at the start of the chapter on page 126.

The auxiliary heater can be operated when the ignition is switched on and off.

### Opening the Auxiliary heater menu





Auxiliary heater menu in the Infotainment system.

1. *Climatronic*: Open the air conditioning menu in the Infotainment system.
2. *Climatronic*: Tap the  function button.
1. *Manual air conditioning system*: Press the  button in the Infotainment system.
2. *Manual air conditioning system*: Tap the  function button.
3. *Manual air conditioning system*: Tap the  function button.

### Switching on the auxiliary heater





Immediate heating function for the auxiliary heater on the air conditioning block.

1. Press the immediate heat button .
- Or:** switch on the *Heat/ventilate now* function in the Auxiliary heater menu.
- Or:** press the  button on the remote control → page 127.
- Or:** program a departure time → page 127.

The auxiliary heater will not switch on if the 12-volt vehicle battery has a low charge level or the fuel tank is empty.

### Switching off the auxiliary heater manually

1. Press the immediate heat button .
- Or:** press the  button on the remote control → page 127.

### Auxiliary heater switches off automatically

The auxiliary heater switches itself off automatically if one of the following conditions is met:

- When the programmed departure time has been reached or when the set running time has expired → page 127.
- When the yellow indicator lamp  (fuel gauge) lights up → page 28.
- If the charge level of the 12-volt vehicle battery is too low.



In order to burn the remaining fuel in the auxiliary heater, the auxiliary heater will continue running for a short time after being switched off manually or automatically.



 When the vehicle is at a standstill, the auxiliary heater can be activated up to three times in succession for the maximum operating duration.

 Operating noises can be heard if the auxiliary heater is switched on.

 The 12-volt vehicle battery will discharge if the auxiliary heater or auxiliary ventilation is run several times over an extended period. Drive the vehicle for an appropriate distance in order to recharge the 12-volt vehicle battery.

 If you park on a downhill slope with very little fuel in the tank (just above reserve level), the fuel gauge may be inaccurate and lead to functional restrictions of the auxiliary heater.

## Programming the auxiliary heater and auxiliary ventilation

 Please refer to  and  at the start of the chapter on page 126.

The auxiliary heater is programmed in the Infotainment system.

### Changing operating mode

1. Open the **Auxiliary heater** menu.
2. To change the operating mode, tap the function buttons **Heating** or **Ventilation**.

At high outside temperatures, the auxiliary ventilation function supplies fresh air to the vehicle interior and helps prevent a build-up of heat.

### Setting the running time of the auxiliary heater

1. Open the **Auxiliary heater** menu.
2. Tap the **Adjust** function button.
3. To set the duration, tap the **Running time** function button.

The set running time applies when the auxiliary heater is switched on with the immediate heat button  or using the remote control.

The maximum running time of the auxiliary heater is 60 minutes.

### Programming departure time

Activation is always for one heating or ventilation period only. The departure time must be activated for every start.

1. Before programming, check that the date and time set in the vehicle are correct → page 34.
2. Open the **Auxiliary heater** menu.
3. Tap the **Adjust** function button.
4. Choose one of the memory locations for a **Departure time**.
5. Tap the **Activate** function button.

*Manual air conditioning system:* the programmed departure time determines the time at which the auxiliary heater or ventilation should switch off. The point at which the heating or ventilation process starts is determined depending on the programmed running time.

◀ *Climatronic:* On the basis of the programmed departure time, the vehicle automatically calculates the start time for heating or ventilation to the currently set temperature. This also depends on the outside temperature.

### Checking programming

If a departure time has been activated, the yellow LED in the immediate heat button  will light up on the Climatronic air conditioning block for approximately 10 seconds after the ignition is switched off.

### WARNING

The emissions from the auxiliary heater contain carbon monoxide, which is an odourless and colourless poisonous gas. Carbon monoxide can cause people to lose consciousness. It can also cause death.

- Never program the auxiliary heater to switch on and run when the vehicle is in an unventilated or enclosed space.

## Remote control for the auxiliary heater and auxiliary ventilation

### Remote control of the auxiliary heater and auxiliary ventilation

With the remote control, the fuel-operated auxiliary heater can be switched on and off from outside the vehicle.



Fig. 112 Remote control for the auxiliary heater.

#### Switching on the auxiliary heater and auxiliary ventilation with the remote control

1. Press the  button for around 1 second → Fig. 112, → .

#### Switching off the auxiliary heater and auxiliary ventilation with the remote control

1. Press the  button for around 1 second → Fig. 112.

#### LED in the remote control

The LED indicates various operating states after you press a button → Fig. 112 ②.

#### Lit up

- **Green:** auxiliary heater is switched on.
- **Red:** auxiliary heater is switched off.

#### Flashes irregularly

- **Green:** auxiliary heater operation is blocked. The fuel tank is nearly empty, the 12-volt vehicle battery charge level is too low or a malfunction has occurred. Refuel and drive for a sufficiently long time in order to charge the 12-volt vehicle battery, or go to a suitably qualified workshop. Volkswagen recommends using a Volkswagen dealership.

#### Flashes regularly

- **Red or green:** switch-on or switch-off signal not received. Reduce your distance from the vehicle.

#### Lights up or flashes

- **Orange:** the button cell in the remote control is weak. Replace the button cell.

#### Range

The remote control has a range of several hundred metres when the button cell is fully charged and under ideal conditions.

- Keep a distance of at least 2 m (7 ft) between the remote control and the vehicle.
- Avoid obstacles between the remote control and vehicle.
- Hold the remote control with the chrome trim → Fig. 112 ① pointing vertically upwards.
- Do not cover the aerial.

Poor weather conditions, nearby buildings or a weak button cell will significantly reduce the range.

#### WARNING

The emissions from the auxiliary heater contain carbon monoxide which is an odourless and colourless poisonous gas. Carbon monoxide can cause people to lose consciousness. It can also cause death.

- Never switch on the auxiliary heater and leave the auxiliary heater running if the vehicle is located in enclosed or unventilated spaces.

#### WARNING

Parts of the auxiliary heater's exhaust system become very hot. This can cause fires.

- Park the vehicle so that no part of the exhaust system can come into contact with any inflammable material underneath the vehicle, e.g. dry grass.

#### NOTICE

The remote control contains electronic components which can be damaged by moisture, strong vibrations and direct sunlight.

- Protect the remote control from moisture, strong vibrations and direct sunlight. <

#### Replacing the button cell in the remote control

The button cell in the remote control must be replaced if the LED no longer lights up.



**Fig. 113** Remote control: cover for battery compartment.

### Replacing the button cell

1. Insert a suitable tool, e.g. a screwdriver, into the recess on the remote control housing in the direction of the arrow → Fig. 113.
2. Using the tool, lever off the battery cover in upward direction until the housing catches are released.
3. Push the battery cover slightly in the direction of the arrow.
4. Remove the battery cover.
5. To remove the button cell, carefully insert a screwdriver, for example, in the recess on the button cell.
6. Lever up the button cell with the screwdriver until the button cell is released from the holder.
7. Remove the button cell.
8. Insert a new button cell of the same type so that it engages in the holder. Pay attention to the information on the correct polarity of the button cell located on the inner side of the battery cover.
9. Place the battery cover on the remote control housing and press slightly until the battery cover engages in position.

### **!** DANGER

If button cell batteries are swallowed or get into the wind pipe, this can lead to serious or even fatal injuries due to suffocation or internal burns within a very short space of time.

- Call for medical help immediately if you suspect that someone has swallowed a button cell battery.
- If the battery cover cannot be closed, do not use the remote control.

- Always keep the remote control and key fob with button cells out of the reach of children.

### **!** NOTICE

Unsuitable button cells can damage the remote control.

- Replace a discharged button cell only with a new button cell of the same voltage rating, size and specification.
- Pay attention to the correct polarity when inserting the button cell.

 Dispose of discharged button cells in an environmentally-friendly way.

 The button cell in the remote control may contain perchlorate. Observe the legal requirements for disposal.

## Troubleshooting

### Cooling mode **A/C** cannot be switched on or its function is restricted

Cooling mode **(A/C)** works only when the engine is running and at ambient temperatures above +3°C (+38°F).

Cooling mode **(A/C)** is switched off when the engine is very hot.

1. Switch on the blower.
2. Check the fuse of the air conditioning system → page 297.
3. Replace enhanced air filter with activated carbon → page 353.
4. If the fault persists, go to a correspondingly qualified workshop. Volkswagen recommends using a Volkswagen dealership.

### **!** NOTICE

If the air conditioning system does not work, switch it off immediately to avoid secondary damage. Have the air conditioning system checked by a correspondingly qualified workshop. Volkswagen recommends using a Volkswagen dealership.

### The heating and fresh air system cannot be switched on or its function is restricted

The heating and defrost function are more effective when the engine is warm.

1. If the fault persists, go to a correspondingly qualified workshop. Volkswagen recommends using a Volkswagen dealership.

### Condensation on the windows

Condensation may form on the windows if they are colder than the ambient temperature and the air is very humid. Cold air can absorb less moisture than warm air, which is why condensation frequently forms on windows in cold weather.

1. Keep the air intake in front of the windscreen free of ice, snow and leaves in order to improve heating and cooling performance → page 355.
2. Do not cover the air vents in the rear of the luggage compartment. Ensuring they are not covered will allow air to flow through the vehicle from the front to the rear.
3. Switch on the defrost function → page 122.

### The wrong unit of temperature has been set

1. Change the unit of temperature for all temperature displays in the vehicle using the Infotainment system → page 37.

### Water or water vapour under the vehicle

If the humidity and temperature outside the vehicle are high, condensation can drip off the evaporator in the cooling system and form a pool underneath the vehicle. This is normal and does not indicate a leak.

If the outside humidity is high and the outside temperature low, condensation may evaporate when the auxiliary heater is running. If this is the case, steam may appear underneath the vehicle. This is not a sign that the vehicle is damaged.

### The auxiliary heater cannot be switched on

When the vehicle is at a standstill, the auxiliary heater can be switched on up to three times in succession for the maximum operating duration.

If you park on a downhill slope with very little fuel in the tank, just above reserve level, the fuel gauge may be inaccurate and lead to functional restrictions of the auxiliary heater.

The 12-volt vehicle battery will be discharged if the auxiliary heater runs several times for an extended period.

1. Drive the vehicle for an appropriate distance in order to recharge the 12-volt vehicle battery.

### Noise when the auxiliary heater is switched on

Operating noises when the auxiliary heater is switched on are normal and not a sign of a malfunction. ◀

# Driving

## Notes on driving

### Pedals



**Fig. 114** In the footwell: pedals in vehicles with a manual gearbox.

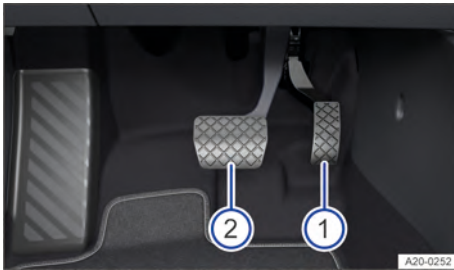

**Fig. 115** In the footwell: pedals in vehicles with an automatic gearbox.

- ① Accelerator
- ② Brake pedal
- ③ *In vehicles with a manual gearbox:* Clutch pedal

The operation and freedom of movement of all pedals must never be impaired by objects or floor mats.

Use only those floor mats which leave the pedal area free and can be securely fastened in the footwell.

### **⚠ WARNING**

Objects in the driver footwell can hinder pedal operation. This can lead to loss of control of the vehicle and increase the risk of serious injury.

- Make sure that all pedals can always be operated without any hindrance.
- The floor mats must always be properly secured in the footwell.

- No additional floor mats or other floor coverings should be placed over the fitted floor mat.
- Make sure that no objects can enter the driver footwell while the vehicle is in motion.
- If there are any objects in the footwell, remove them when the vehicle is parked.
- Always wear shoes that provide good grip for your feet when using the pedals.

### **⚠ WARNING**

Always observe current traffic regulations and speed limits, and think ahead when driving. Correct interpretation of a driving situation can make the difference between reaching your destination safely and having an accident with serious injuries.

- When travelling long distances, stop and take a break regularly – at least every 2 hours.

### **⚠ WARNING**

Driving under the influence of alcohol, drugs, medication or narcotics can cause serious accidents and fatal injuries.

- Alcohol, drugs, medication and narcotics can severely impair perception, reaction times and driving safety. This could cause you to lose control of the vehicle.

### **ⓘ NOTICE**

The pedals must be freely operable at all times. For example, a larger brake pedal travel will be necessary in order to stop the vehicle if a brake circuit fails. The brake pedal will have to be depressed further and harder than normal.

### Gear-change indicator

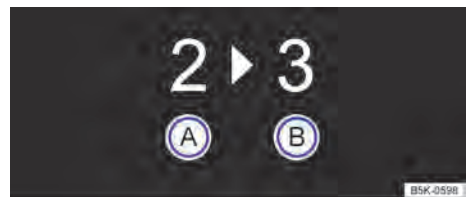

**Fig. 116** On the instrument cluster display: gear-change indicator.

- Ⓐ Currently selected gear.
- Ⓑ Recommended gear.

Depending on the vehicle equipment, the instrument cluster display may indicate the gear which

should be selected to reduce fuel consumption while the vehicle is in motion → Fig. 116.

*Vehicles with an automatic gearbox:* the gearbox must be in Tiptronic mode for this → page 149.

No recommended gear is indicated if the most suitable gear is already selected. The currently selected gear is displayed.

### ⚠ CAUTION

The gear-change indicator is designed only to assist the driver and cannot replace the driver's own judgement.

- The driver has full responsibility for selecting the correct gear in all situations, e.g. when overtaking or when driving up and down hills.

### Information on "cleaning" the particulate filter

The engine management system recognises when the particulate filter is becoming saturated and supports regeneration of the filter by recommending the most suitable gear when driving. As an exception compared with normal driving, this may mean driving with an increased engine speed → page 290.

 Driving in the correct gear can help to reduce fuel consumption.

 The gear-change indicator display goes out when the clutch is depressed in vehicles with a manual gearbox or when the Tiptronic position is deselected in vehicles with an automatic gearbox. <

## Driving economically

Adopting the correct driving style can reduce fuel consumption, pollution and wear-and-tear on the engine, brakes and tyres. The following section lists a few tips for easing the strain on the environment and your bank account.

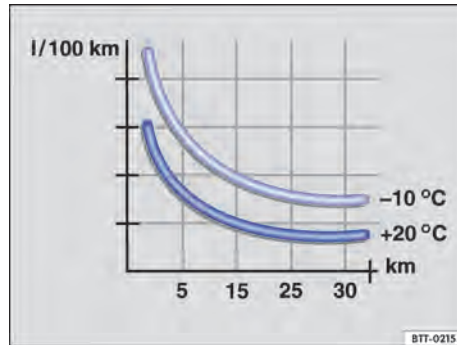

Fig. 117 Fuel consumption in litres per 100 km at two different outside temperatures.

### Think ahead when driving

Repeated acceleration and braking will increase fuel consumption. Keeping a close eye on the traffic can help to avoid frequent acceleration and braking. Keeping your vehicle at a sufficient distance from the vehicle in front can help you to think ahead when driving.

### Use coasting

*Vehicles with an automatic gearbox:* When the selector lever is in position **D** and neither the accelerator nor the brake pedal is depressed, the vehicle will roll ("coast") with practically no energy being consumed.

### Change gear to save energy

Shifting up early at engine speeds of 2,000 rpm can save energy. Do not drive gears to the limit and avoid high revs.

- *Vehicles with a manual gearbox:* change from first to second gear immediately after moving off.
- *Vehicles with an automatic gearbox:* accelerate slowly and avoid using the kickdown function.
- Pay attention to the gear-change indicator → page 131.
- Use the driving profile **ECO** if possible → page 156.

### Avoid full throttle

The rolling and air resistance increase at excessively high speeds. This in turn increases the force needed to move the vehicle. Never drive the vehicle at top speed.

### Reduce idling

Drive off immediately at low engine speeds. If you are stopped for a long period, do not allow the engine to idle but switch it off, e.g. when in a traffic jam or at a railway crossing.

In vehicles with an activated start/stop system, the engine can switch off automatically when the vehicle is stopping and when the vehicle is stationary → page 144.

#### **Do not overfill the fuel tank**

Filling the fuel tank all the way to the top will increase the vehicle weight. A fuel tank that is half to three quarters full is sufficient for urban journeys in particular.

#### **Avoid short journeys**

Engines consume a lot of fuel when cold. They do not reach optimum operating temperature until the vehicle has travelled a few kilometres (miles). The fuel consumption is above average at very low ambient temperatures, e.g. in winter → Fig. 117. Plan your journeys economically and combine several short trips.

#### **Have your vehicle serviced on a regular basis**

Regular maintenance is an essential prerequisite for economical driving and increases the service life of the vehicle.

#### **Observe the correct tyre pressures**

An inadequate tyre pressure does not just mean greater wear, but also increases the rolling resistance of the tyres and thus the fuel consumption. Use tyres with optimised rolling resistance.

Adjust the tyre pressure according to the vehicle load:

- Observe the information on the tyre pressure sticker → page 334.
- Tyre Pressure Loss Indicator → page 328.
- Tyre Pressure Monitoring System → page 329.

#### **Use low viscosity engine oils**

Synthetic, low viscosity engine oils decrease frictional resistance in the engine and spread better and more quickly, especially for cold starts → page 314, → page 315.

#### **Do not drive with unnecessary loads in the vehicle**

You can reduce fuel consumption by clearing out the luggage compartment before setting off, for exam-

ple by removing empty drink crates or unused child seats.

In order to keep the drag coefficient of the vehicle as low as possible, remove attachments and add-on parts such as ski, bicycle or roof carriers after use.

#### **Save energy**

The alternator powered by the engine generates electricity for convenience functions, such as the air conditioning system, windscreen heating or ventilation system. Saving electrical energy is easy, for example:

- At high ambient temperatures, ventilate the car before starting a journey and drive a short distance with open window. Only then switch on the air conditioning system.
- Switch off convenience systems as soon as they have served their purpose.

#### **⚠ WARNING**

Adapt your speed and distance from the vehicles ahead to suit visibility, weather, road and traffic conditions.

#### **ⓘ NOTICE**

Never allow the vehicle to roll down mountains or hills in the neutral position **N**. The gearbox will not be lubricated and could be damaged.



Your Volkswagen dealership will gladly provide you with further information on correct maintenance and replacement parts that are particularly energy-efficient, e.g. new tyres.



In vehicles equipped with active cylinder management (ACT) depending on the equipment level, engine cylinders can be automatically deactivated in driving situations with low power requirements. When a cylinder is deactivated, no fuel is injected into that cylinder, which leads to an overall reduction in fuel consumption. <

## Think Blue. Trainer.

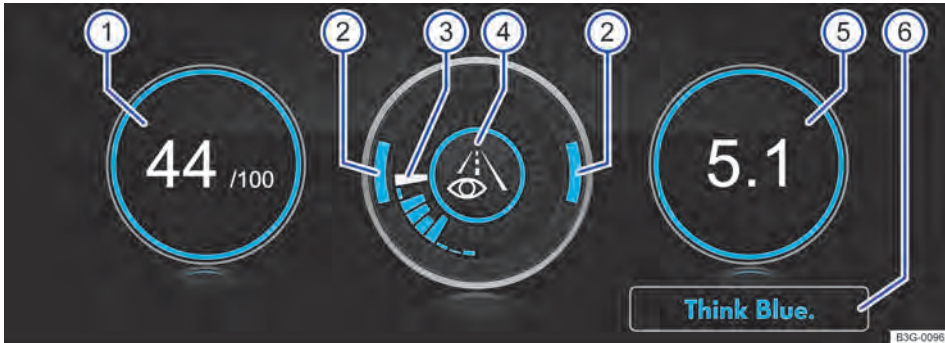

Fig. 118 In the Infotainment system: Think Blue. Trainer.

The Think Blue. Trainer. is available depending on the vehicle equipment and is not available in all models.

### ① “Blue Score”:

The higher the displayed value on a scale from 0 to 100, the more efficient your driving style. A blue border symbolises an efficient and constant driving style. A grey border indicates an inefficient driving style.

Tap the display to open the statistics for the last 30 minutes of driving *Since start*.

### ② Acceleration and braking:

At a constant speed, two arcs appear in the central area. The arcs move up and down during acceleration and braking.

### ③ Progress display:

The efficiency of the driving style is indicated by the blue bars. The white bar stores a blue bar approximately every five seconds.

The larger the bar, the more efficient the driving style has been.

### ④ Driving tips:

- 🚗 Think ahead when driving.
- ➡ Gear change indicator.
- ⚙️ Adapt speed.

**ECO** Driving economically.

### ⑤ Fuel consumption:

The display shows the average fuel consumption *Since start* in l/100 km or in mpg. A blue border symbolises an efficient and constant driving style. A grey border indicates an inefficient driving style.

Tap the display to open the statistics for the last 30 minutes of driving *Since start*.

### ⑥ Tips for saving energy:

Tap the **Think Blue.** function button to access additional tips.

The Think Blue. Trainer analyses and visualises your driving style and helps you to drive more economically.

### Opening the Think Blue. Trainer.

1. Switch on the ignition.
2. Switch on Infotainment system if necessary.
3. Press the **MENU** button or function button, depending on equipment.  
**Or:** press the **CAR** button or function button.
4. Tap the **(Vehicle) ▶ (Selection) ▶ Think Blue. Trainer.** function buttons.

### ⚠️ WARNING

Accidents and injuries can occur if the driver is distracted. Operating the Infotainment system can distract you from the road.

- Drive with your full attention and with responsibility.

🌿 Inform yourself about other ways of protecting the environment. Think Blue. is the global Volkswagen brand for sustainability and environmental friendliness.



## Information on the brakes

New brake pads cannot generate the full braking effect during the first 200 to 300 km (100 bis 200 miles) and must first be run in → ⚠. However, you can compensate for the slightly reduced braking force by applying more pressure to the brake pedal. During the run-in period, the braking distance is longer when the brakes are depressed fully or during emergency braking than with brake pads that have been fully run in. In the run-in period, the brakes should not be depressed fully and situations should be avoided that create a heavy load on the brakes, e.g. when driving up close to the vehicle ahead.

The wear of the brake pads depends to a great extent on the conditions under which the vehicle is operated and the way in which the vehicle is driven. If the vehicle is used for regular urban trips or short journeys and is driven with a sporty driving style, the brake pads must be regularly checked by a correspondingly qualified workshop. Volkswagen recommends using a Volkswagen dealership.

When driving with wet brakes, for example after driving through water, after heavy rainfall or after washing the vehicle, the braking effect may be delayed as the brake discs will be wet, or possibly iced up (in winter). The brakes must be "dried" as quickly as possible by careful braking at higher speed. Please ensure that no following vehicle and no other road user is put at risk as a result of this action → ⚠.

Any salt layer accumulating on the discs and pads will delay the braking effect and increase the braking distance. If the brakes on the vehicle have not been applied for a long time on roads that have been gritted with salt, the layer of salt must be reduced through careful braking → ⚠.

Corrosion on the brake discs and dirt in the brake pads are facilitated through long periods of inactivity, low mileage and low load levels. If the brake pads have been hardly used or if they are corroded, Volkswagen recommends that the brake discs and brake pads be cleaned by braking strongly several times from high speed. Please ensure that no other vehicles and no road users are put at risk as a result of this action → ⚠.

### ⚠ WARNING

Driving with worn brake pads or with a faulty brake system can cause accidents and serious injuries.

- If you have reason to believe that the brakes are worn down or the brake system is faulty, go to a correspondingly qualified workshop immediately and have the brake system checked and

have any worn brake pads replaced. Volkswagen recommends using a Volkswagen dealership.

### ⚠ WARNING

New brake pads will not have the optimal braking effect when first fitted.

- New brake pads cannot generate the full braking effect during the first 300 km (200 miles) and must first be run in. A reduced braking effect can be increased by applying more pressure to the brake pedal.
- Drive with particular care with new brake pads to reduce the risk of accidents, serious injuries and loss of control of the vehicle.
- Never drive too close to other vehicles when running in new brake pads, and never create a driving situation that will place a heavy load on the brakes.

### ⚠ WARNING

Constant braking will cause the brakes to overheat. This can reduce the braking effect, increase the braking distance and, in certain circumstances, cause the brake system to fail completely.

- Never "ride" the brake pedal or depress the brake pedal too often and for too long.

### ⚠ WARNING

Overheated brakes reduce the braking effect and considerably increase the braking distance.

- When driving downhill, the brakes are placed under particular strain and become hot very quickly.
- Before driving down a long, steep gradient, reduce your speed by changing to a lower gear with a manual gearbox or in Tiptronic mode of the automatic gearbox. This will make use of the engine braking effect and relieve the load on the brakes.
- Non-standard or damaged front spoilers could restrict the airflow to the brakes and cause them to overheat.

### ⚠ WARNING

Wet brakes or brakes coated with ice or road salt react more slowly and require longer braking distances.

- Carefully test the brakes.
- Always carry out a few careful braking operations to dry the brakes and clean off any coating of ice and salt when visibility, weather, road and traffic conditions permit.

 If the front brake pads are tested, the rear brake pads should be tested at the same time. Regularly check the thickness of the brake pads through the openings in the rims or from the underside of the vehicle. If necessary, remove the wheels to carry out a comprehensive check. Further information can be obtained from a correspondingly qualified workshop Volkswagen recommends using a Volkswagen dealership. <

## Driving a loaded vehicle

For good vehicle handling when driving a loaded vehicle, please observe the following:

- Stow all items of luggage securely → page 266.
- Accelerate particularly cautiously and carefully.
- Avoid sudden braking and driving manoeuvres.
- Brake earlier than in normal driving.
- If applicable, observe the information concerning the roof carrier → page 281.
- If applicable, observe the information about driving with a trailer → page 273.

### WARNING

Shifting loads can severely impair the vehicle's stability and driving safety, lengthen the braking distance in the event of braking hard, and cause accidents and serious injuries.

- Secure the load properly to prevent it from slipping.
- Use suitable lashing or securing straps when securing heavy objects.
- Securely engage the rear seat backrests and also the adjustable rear seats, if installed. <

## Driving with an open boot lid

Driving with an open boot lid is particularly dangerous. Ensure that the open tailgate and any objects are secured properly, and take appropriate measures to reduce the quantity of toxic exhaust fumes entering the vehicle.

### WARNING

Driving with an unlocked or open boot lid can cause serious injuries.

- Always drive with the boot lid closed.

- Stow all objects securely in the luggage compartment. Loose objects can fall out of the luggage compartment and injure other road users.
- Always drive carefully and ensure that you think ahead.
- Avoid any abrupt or sudden driving and braking manoeuvres as this can cause the open boot lid to move unpredictably.
- Mark any objects protruding from the luggage compartment to ensure that they are visible to other road users. Observe legal requirements for this.
- Any objects protruding from the luggage compartment must never be held in position by the boot lid.
- If it is necessary to drive with the boot lid open, always remove a luggage rack and its load from the boot lid.

### WARNING

Poisonous exhaust fumes can enter the vehicle interior when the tailgate is open. This could result in loss of consciousness, carbon monoxide poisoning, serious injury and accidents.

- Always drive with the boot lid closed in order to prevent poisonous exhaust gases from entering the vehicle.
- If exceptional circumstances require you to drive with an open tailgate, you must do the following to reduce the quantity of toxic exhaust fumes that could enter the vehicle:
  - Close all windows.
  - Close the glass roof.
  - Switch off air recirculation mode → page 123.
  - Open all vents in the dash panel.
  - Switch the blower to the highest setting → page 122.

### NOTICE

The vehicle height, and possibly the length, are different when the boot lid is open. <

## Driving through water on roads

Please follow these rules to help prevent damage to your vehicle when driving through water, for example if the road is flooded:

- The water level must be no higher than the lower edge of the vehicle body → .

- Do not drive faster than walking speed.
- Never stop the vehicle, reverse or switch off the engine while in water.
- Oncoming vehicles will create waves that could increase the water level for your vehicle to such an extent that it is not safe to drive through the water.
- Always deactivate the start/stop system manually when driving through water → page 144.

### **WARNING**

After driving through water, mud, slush etc., the brakes may react slowly and the braking distance will be increased as the brake discs and pads will be wet, or possibly iced up in winter.

- Carry out careful braking manoeuvres to dry and de-ice the brakes. Ensure that you do not endanger any other road users or violate any legal requirements when doing so.
- Avoid abrupt and sudden braking manoeuvres directly after driving through water.

### **NOTICE**

If you drive through water, parts of the vehicle, such as the electrical parts, could sustain severe damage.

- Never drive through salt water as salt can cause corrosion. Rinse all components that have been exposed to salt water immediately with fresh water.

## Running in the combustion engine

A new combustion engine has to be run in during the first 1500 kilometres (approx 1,000 miles). All moving parts have to adapt themselves to each other. During the first few operating hours, the combustion engine has higher internal friction than it does later.

### Up to 1000 kilometres (about 600 miles):

- Do not depress the accelerator fully.
- Do not load the combustion engine with more than 2/3 of the top engine speed.
- Do not drive with a trailer attached → page 273.

### Within 1000 to 1500 kilometres (about 600 to 1000 miles):

1. Gradually increase speed and engine speed.

The style of driving during the first 1500 kilometres (about 1,000 miles) will also affect the combustion

engine quality. Even after this time – and especially with a cold combustion engine – drive the vehicle at moderate speeds in order to reduce engine wear and to increase the mileage that the engine can cover.

Do not drive at engine speeds that are too low. Always shift down gear if the combustion engine is not running “smoothly”.

New tyres and brake pads have to be run in carefully → page 331, → page 135.

 If the new combustion engine is run in gently, its life will be increased and its oil consumption reduced.

## Using the vehicle in other countries and continents

The vehicle has been manufactured specifically for a particular country and complies with the registration regulations that applied in that country at the time of vehicle production.

If you want to use the vehicle abroad temporarily or for a short period, all relevant information and instructions should be followed.

In some countries, special safety standards and regulations apply that the vehicle may not comply with. Volkswagen recommends that you visit your Volkswagen dealership before travelling abroad to find out about any legal requirements at your destination.

If the vehicle is going to be sold in another country or used in another country for an extended period, the legal requirements applicable in that country must be observed.

In some cases, certain equipment will have to be fitted or removed and functions deactivated. The scope of servicing and the type of servicing could also be affected. This is particularly important if the vehicle is driven in another climatic region for a long period of time.

Because different frequency bands are used in different countries, the factory-fitted Infotainment system may not work in other countries.

### **NOTICE**

- Volkswagen is not responsible for any vehicle damage caused by low-quality fuel, inadequate servicing work or lack of availability of Genuine Parts.
- Volkswagen cannot be held responsible if the vehicle does not comply with or only partly com-

plies with the relevant legal requirements in other countries and continents.

## Starting and stopping the engine

### Troubleshooting

#### ⚠ Brake system fault

The warning lamp lights up red. A text message may also be displayed.

1. **Do not drive on!** Seek expert assistance as soon as possible.

#### ⚠ Brake pad wear indicator

The indicator lamp lights up yellow. The brake pads are worn.

1. In this case, go to a correspondingly qualified workshop immediately and have the system checked. Volkswagen recommends using a Volkswagen dealership.
2. All brake pads should be checked and renewed as necessary.

#### Unusual noises when braking

If you hear scratching or squeaking noises each time you brake, this is an indication that your brake pads on the front and rear axle are worn.

1. In this case, go to a correspondingly qualified workshop immediately and have the system checked. Volkswagen recommends using a Volkswagen dealership.
2. All brake pads should be checked and renewed as necessary.

#### If the braking performance of the vehicle changes

If the brake pads are worn or if you establish that the vehicle is no longer braking in the usual way, for example, a sudden lengthening of the stopping distance:

1. In this case, go to a correspondingly qualified workshop immediately and have the system checked. Volkswagen recommends using a Volkswagen dealership.
2. All brake pads should be checked and renewed as necessary.

### Ignition lock

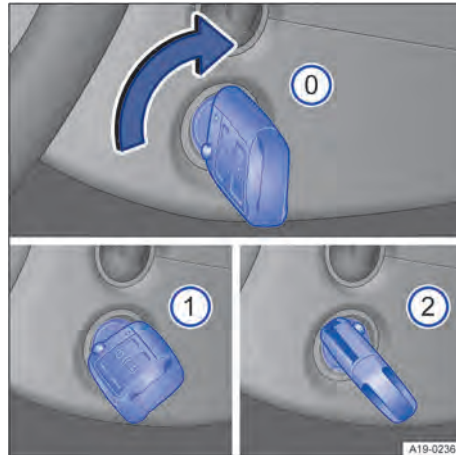

**Fig. 119** To the right of the steering wheel: positions of the vehicle key in the ignition lock.

- 0 Ignition switched off. The vehicle key can be removed.
- 1 Ignition switched on. Steering lock can be released.

The diesel engine is pre-heated and the indicator lamp  lights up yellow.

- 2 *Vehicles with a manual gearbox:* Depress the clutch pedal. Start the engine. Release the vehicle key. Once released, the vehicle key moves back to position 1.

*Vehicles with an automatic gearbox:* Press the brake pedal and start the engine. Release the vehicle key. Once released, the vehicle key moves back to position 1.

The steering lock can be activated when there is no vehicle key in the ignition lock.

#### Ignition switched on warning

A warning message appears in the instrument cluster display if the driver door is opened while the ignition is switched on. An acoustic signal may also be given.

The warning is a reminder that the ignition must be switched off before leaving the vehicle.

## **⚠ WARNING**

Careless or unsupervised use of the vehicle key can lead to accidents or injuries.

- Always switch off the engine and take all vehicle keys with you when you leave the vehicle. Children or unauthorised persons could lock the vehicle, start the engine or switch on the ignition and operate electrical equipment such as window regulators, which can cause serious injury.
- Never leave children or people requiring assistance alone in the vehicle when the vehicle is locked. They could become trapped in the vehicle in an emergency and may not be able to get themselves to safety. For example, locked vehicles may be subjected to very high or very low temperatures depending on the season. This can cause serious injuries and illness or fatalities, especially among small children.
- Never start the engine in unventilated or closed spaces or allow it to run in unventilated or closed spaces. The exhaust fumes contain carbon monoxide, an odourless and colourless toxic gas. Carbon monoxide can cause people to lose consciousness. It can also cause death.
- Never remove the vehicle key from the ignition if the vehicle is in motion. The steering column lock may be activated and you will no longer be able to steer the vehicle.
- Always completely unfold the key bit of the vehicle key and lock it in this position.
- Only attach light objects weighing less than 100 g (about 3.5 oz) to the vehicle key.

## **ⓘ NOTICE**

The 12-volt battery may be discharged unintentionally and prevent the engine from restarting if the ignition is switched on while the engine is switched off.

- Always switch off the ignition before you leave the vehicle.

**ⓘ** Select the selector lever position **P** if the vehicle key cannot be removed. If necessary, press the lock button in the selector lever and then release it.

**ⓘ** *Depending on market for vehicles with DSG dual clutch gearbox:* If the vehicle key is removed when a position is engaged, the engine will be switched off and the handbrake activated automatically.

## **Starter button**

The starter button replaces the ignition lock (Press & Drive).



**Fig. 120** In the lower section of the centre console: starter button for starting the engine.

*Vehicles with a manual gearbox:* The engine is started by pressing the starter button with the clutch pedal depressed.

*Vehicles with an automatic gearbox:* The engine is started by pressing the starter button with the brake pedal depressed.

The vehicle can be activated only if there is a valid vehicle key in the vehicle.

Depending on model, the starter button flashes to indicate readiness for operation.

**When leaving the vehicle,** the electronic steering column lock will be activated when the ignition is switched off and the driver door is opened → page 154.

### **Switching the ignition on or off**

1. Press the starter button once without depressing the brake or clutch pedal → **⚠**.

### **Automatic ignition switch-off**

Once the vehicle detects that the driver is absent after the combustion engine is switched off, the ignition will be switched off automatically after a certain period of time.

### **Engine restart function**

If no valid vehicle key is detected in the vehicle interior once the engine has been switched off, the engine can be restarted within approximately five seconds. A corresponding message appears on the instrument cluster display.

After this time, the engine cannot be restarted without a valid vehicle key in the vehicle interior.

## WARNING

Unintentional vehicle movements can cause serious injury.

- Do *not* depress the brake pedal when switching on the ignition because the engine will otherwise start immediately.

## WARNING

Careless or unsupervised use of the vehicle key can lead to accidents or injuries.

- Always switch off the engine and take all vehicle keys with you when you leave the vehicle. Children or unauthorised persons could lock the vehicle, start the engine or switch on the ignition and operate electrical equipment such as window regulators, which can cause serious injury.
- Never leave children or people requiring assistance alone in the vehicle when the vehicle is locked. They could become trapped in the vehicle in an emergency and may not be able to get themselves to safety. For example, locked vehicles may be subjected to very high or very low temperatures depending on the season. This can cause serious injuries and illness or fatalities, especially among small children.
- Never start the engine in unventilated or closed spaces or allow it to run in unventilated or closed spaces. The exhaust fumes contain carbon monoxide, an odourless and colourless toxic gas. Carbon monoxide can cause people to lose consciousness. It can also cause death.

 Before leaving the vehicle, always switch off the ignition manually and observe any information shown in the instrument cluster display.

 Leaving the vehicle stationary for long periods with the ignition switched on can discharge the 12-volt vehicle battery so that the engine can no longer be started. ◀

## Starting the engine

### Starting the engine

1. Switch on the ignition.
2. *Vehicles with a diesel engine:* When the diesel engine is pre-heated, the indicator lamp  lights up in the instrument cluster.
3. Depress and hold the brake pedal until the electronic parking brake has been switched off.
4. *Vehicles with a manual gearbox:* fully depress the clutch pedal and hold it until the engine has

been started. Move the gear lever to neutral position.

*Vehicles with an automatic gearbox:* Move the selector lever to position **N** or select parking lock **P**.

*Vehicles with DSG dual clutch gearbox:* Move the selector lever to position **N** or select parking lock **P**.

5. *Vehicles with ignition lock:* turn the vehicle key further in the ignition lock – do not depress the accelerator. Release the vehicle key once the engine has started.  
*Vehicles with starter button:* Press and hold the starter button → page 139 without depressing the accelerator. There must be a valid vehicle key in the vehicle and the brake must be depressed before the engine can be started. Release the starter button once the engine has started.
6. If the engine does not start immediately, stop the starting procedure and try again after around 1 minute.
7. *Vehicles with starter button:* the starter button is deactivated if the vehicle was locked using the vehicle key. If you are in the vehicle and need to start the engine, unlock the vehicle first or perform an emergency start → page 142.

### Carrying out an emotion start (R models only)

1. Switch on the ignition.
2. Switch on the electronic parking brake.
3. Press and hold the starter button without pressing the brake pedal until the message **Please press the brake pedal** appears in the instrument cluster → page 139.
4. Depress and hold the brake pedal until the engine has started – do not press the accelerator. The engine will start with a briefly increased idling speed. There must be a valid vehicle key in the vehicle before the engine can be started.
5. If the engine does not start immediately, stop the starting procedure and try again after around 1 minute.
6. the starter button is deactivated if the vehicle was locked using the vehicle key. If you are in the vehicle and need to start the engine, unlock the vehicle first or perform an emergency start → page 142.

## WARNING

The risk of serious injury can be reduced with the engine running or when starting the engine.

- Never start the engine in unventilated or closed spaces or allow it to run in unventilated or closed spaces. The exhaust fumes contain carbon monoxide, an odourless and colourless toxic gas. Carbon monoxide can cause people to lose consciousness. It can also cause death.
- Never start the engine or allow the engine to run if oil, fuel or any other highly flammable fluids are under or near the vehicle, or are leaking out of the vehicle, e.g. as the result of damage.
- Never leave the vehicle unattended with the engine running, particularly if a gear or position has been selected. The vehicle could move suddenly or something unexpected may happen that may cause damage, fire and serious injuries.
- Never use a start booster. Start boosters may explode and cause the engine to suddenly run at high revs.

### NOTICE

If you attempt to start the engine again while driving or immediately after switching off the engine, this can damage the starter or the engine.

### NOTICE

When the engine is cold, avoid high engine speeds, driving at full throttle and overloading the engine.

### NOTICE

Do not push or tow the vehicle to start it. Unburnt fuel can damage the catalytic converter.

### NOTICE

Never use the starter with a gear selected for driving or tow-starting if the engine does not start, e.g. when the fuel tank is empty. This could cause damage to the starter.

- Refill fuel if necessary → page 283 or obtain jump starting assistance → page 302.
- If the engine does not start, seek expert assistance.



Do not warm up the engine by running it while the vehicle is stationary. Instead, pull off as soon as there is good visibility through the windows. This helps the engine reach operating temperature faster and reduces emissions.



When the engine is started, electrical consumers with a higher power consumption are temporarily switched off.



If there is no vehicle key in the vehicle or if it is not detected, a message will be shown on

the instrument cluster display. This may occur if the vehicle key is disrupted by another radio signal or is covered by another item such as an aluminium suitcase.



The engine cannot, for example, be started with the starter button if the button cell in the vehicle key is weak or flat. Carry out an emergency start → page 142.



When starting from cold, the engine may run with increased operating noise for a short time. This is quite normal, and no cause for concern.



At outside temperatures of less than +5°C (+41°F), fumes may be detected under a vehicle with a diesel engine if the fuel-powered supplementary heater is switched on.

## Switching off the engine

1. Bring the vehicle to a standstill → .
2. Park the vehicle → page 190.
3. *Vehicles with ignition lock:* Switch off the ignition.
4. *Vehicles with starter button:* briefly press the starter button. If the engine cannot be switched off, carry out the emergency switch-off procedure → page 142.
5. Follow the instructions in the instrument cluster → page 20.

### Warning before leaving the vehicle

In order to indicate that the vehicle is capable of rolling when leaving the vehicle, an acoustic warning signal sounds when the driver door is opened and corresponding warning messages appear on the display of the instrument cluster.

*Vehicles with DSG dual clutch gearbox:* If the selector lever is in position **N**, an acoustic warning signal will sound when the driver door is opened and the warning message **The vehicle is not secured against rolling away!** will appear on the instrument cluster display. This warns you that the vehicle could potentially roll away.



### WARNING

Never switch off the engine while the vehicle is in motion. This can lead to a loss of vehicle control, accidents and serious injuries.

- The airbags and belt tensioners do not function.
- The brake servo does not work. More force is required on the brake pedal to stop the vehicle.

- The power steering does not work. More power is needed to steer.
- *Vehicles with ignition lock:* If the vehicle key is removed, the steering lock may activate and you may no longer be able to steer the vehicle.
- *Vehicles with starter button:* When the ignition is switched off, the steering column lock may activate and you will no longer be able to steer the vehicle.

### ⚠ WARNING

The components of the exhaust system become very hot. This can cause fires and serious injuries.

- Never park the vehicle where parts of the exhaust system can come into contact with inflammable material underneath the vehicle, e.g. undergrowth, leaves, dry grass, spilt fuel.
- Never apply additional underseal or anti-corrosion coatings to the exhaust pipes, catalytic converters, heat shields or particulate filter.

### ℹ NOTICE

If the vehicle has been driven at high load for a long period, the engine can overheat when it is switched off.

- Allow the engine to run in neutral for approximately 2 minutes before switching it off in order to avoid damage to the engine.

ℹ In vehicles with an automatic gearbox, the vehicle key can only be removed from the ignition lock if the selector lever is in position P.

ℹ After the engine has been switched off, the radiator fan in the engine compartment may run on for a few minutes. The radiator fan will switch itself off automatically.

## Electronic immobiliser

The immobiliser helps to prevent the engine from being started and driven with an unauthorised vehicle key.

*In vehicles with ignition lock:* There is a chip in the vehicle key. The immobiliser is automatically deactivated by this when a valid vehicle key is inserted in the ignition lock.

*In vehicles with ignition lock:* The electronic immobiliser is automatically activated when the vehicle key is removed from the ignition lock.

*In vehicles with starter button:* There is a chip in the vehicle key. This deactivates the immobiliser auto-

matically when a valid vehicle key is located inside the vehicle.

*In vehicles with starter button:* The electronic immobiliser is activated automatically when there is no longer a valid vehicle key located inside the vehicle.

The engine can only be started using a genuine Volkswagen vehicle key with the correct code. Co-coded vehicle keys are available from a Volkswagen dealership.

ℹ The vehicle cannot be operated properly if you do not have a genuine Volkswagen key. <

## Troubleshooting



Fig. 121 On the right-hand side of the steering column: emergency start function in vehicles with the keyless locking and starting system Keyless Access.

### EPC Fault in engine management system

< The indicator lamp lights up yellow.

Fault in engine management system.

1. Observe any text messages that are shown on the instrument cluster display.
2. Have the engine checked by a correspondingly qualified workshop as soon as possible. Volkswagen recommends using a Volkswagen dealership.

### EPC Fault in engine management system

The indicator lamp lights up in the digital instrument cluster.

The indicator lamp lights up yellow.

The vehicle power has been limited.

The power was limited to prevent overheating of components in the engine management system.



- A corresponding display may appear in the instrument cluster display.
- It is possible to continue driving with reduced power.

The power limitation will be cancelled again in the following cases:

- The components of the engine management system are no longer in a critical temperature range.

### Engine speed limited

The indicator lamp lights up yellow.

The engine speed was limited to prevent the engine from overheating.

The engine speed is shown on the instrument cluster display.

The engine speed limitation will be cancelled again in the following cases:

- Engine is no longer in a critical temperature range.
- Foot is taken off the accelerator.

### together with **EPC** Engine speed limitation due to fault in the engine management system

The indicator lamps light up yellow.

Engine speed limitation is activated due to a fault in the engine management system.

1. Make sure that the displayed engine speed is not exceeded.
2. Have the engine checked by a correspondingly qualified workshop as soon as possible. Volkswagen recommends using a Volkswagen dealership.

### glow plug system or engine management system

*Vehicles with a diesel engine:*

The indicator lamp lights up yellow.

When the diesel engine is being pre-heated, the indicator lamp lights up in the instrument cluster for a few seconds.

The indicator lamp flashes yellow.

There is a fault in the engine management system.

1. Have the engine checked by a correspondingly qualified workshop as soon as possible. Volkswagen recommends using a Volkswagen dealership.

### Fault in engine management system

The indicator lamp flashes in the analogue instrument cluster.

The indicator lamp flashes yellow.

The vehicle power has been limited.

The power was limited to prevent overheating of components in the engine management system.

- It is possible to continue driving with reduced power.

The power limitation will be cancelled again in the following cases:

- The components of the engine management system are no longer in a critical temperature range.

### Vehicle key cannot be removed from the ignition lock

An unauthorised vehicle key has been inserted in the ignition lock.

Remove the vehicle key as follows:

*Vehicles with an automatic gearbox*

1. Press the lock button in the selector lever and release.
2. Remove the vehicle key from the ignition lock.

*Vehicles with a manual gearbox*

1. Remove the vehicle key from the ignition lock.

### No valid vehicle key recognised

A corresponding display will appear in the instrument cluster.

If the button cell in the vehicle key is weak or discharged, it is possible that the vehicle key will not be recognised.

In this case it is necessary to perform an emergency start:

1. Depress and hold the brake pedal.
2. Hold the vehicle key to the right of the steering column trim directly after pressing the starter button → [Fig. 121](#).

The ignition is switched on automatically, and in some cases the engine is started.

### Engine cannot be switched off

The engine cannot be switched off by briefly pressing the starter button.

In this case it is necessary to perform an emergency switch-off procedure:

1. Press the starter button twice within a few seconds or press and hold once.

The motor switches off automatically → page 139.

### Engine cannot be started

A corresponding message will be displayed in the instrument cluster if an unauthorised vehicle key is used or there is a system fault.

1. Use an authorised vehicle key.
2. If the fault persists, seek expert assistance.

### Engine cannot be started

The engine cannot be started with the ignition key or by briefly pressing the starter button while the brake or clutch pedal is depressed.

A fault has developed in the starting system.

1. Turn and hold the vehicle key or press the button until the engine starts.
2. Seek expert assistance.

## Start/stop system

### Start/stop system



**Fig. 122** In the lower part of the centre console: button for the start/stop system.

The start/stop system automatically switches the engine off when the vehicle is coming to a stop and when stationary. When required, the engine restarts automatically.



### Switching on the start/stop system

The function is automatically activated every time the ignition is switched on. The instrument cluster display will show information about the current status.

Always deactivate the start/stop system manually when driving through water.

### Indicator lamps

If the indicator lamp  lights up, the start/stop system is available and automatic engine stop is active.

If the indicator lamp  lights up, the start/stop system is not available or the start/stop system has started the engine automatically → .

### Activating and deactivating the start/stop system automatically

*Vehicles with a manual gearbox:*

1. Disengage the gear and release the clutch pedal when the vehicle is coming to a stop, or when it is stationary. The engine stops.
2. Depress the clutch pedal to restart the engine.

*Vehicles with an automatic gearbox:*

1. To stop, press and hold the brake pedal. The engine switches off shortly before the vehicle reaches a complete standstill or when the vehicle is stationary.
2. Take your foot off the brake pedal or depress the accelerator to restart the engine.

### Important preconditions for automatic engine switch-off

- The driver is wearing their seat belt.
- The driver door is closed.
- The bonnet is closed.
- A minimum engine temperature has been reached.
- *Vehicles with Climatronic:* The temperature of the vehicle interior is within the preset temperature range, and the humidity level is not too high.
- The defrost function of the air conditioning system is not switched on.
- The charge level of the 12-volt vehicle battery is sufficient.
- The temperature of the 12-volt vehicle battery is not too low or too high.
- The vehicle is not on a steep incline.
- The steering wheel is not turned too sharply.
- The windscreen heating is not switched on.
- Reverse gear is not engaged.
- Park Assist is not active.
- The **Offroad** driving profile is not activated.

The engine can also switch off later if the conditions for automatic engine switch-off are fulfilled only after the vehicle has come to a stop, e.g. if the defrost function is switched off when stationary.

### Conditions for an automatic restart

The engine can start automatically under the following conditions:

- If the temperature inside the vehicle greatly increases or decreases.

- If the vehicle starts rolling.
- If the electric voltage of the 12-volt vehicle battery drops.
- If the steering wheel is moved.

As a general rule, the engine always starts again automatically when required by the detected situation and the vehicle.

#### Conditions that require a manual engine start

The engine must be started manually in the following conditions:

- If the driver door is opened.
- If the bonnet is opened.

#### Activating and deactivating the start/stop system manually

Deactivating the start/stop system manually:

1. Press the  button in the centre console to deactivate the system manually. If the start/stop system has been deactivated, the indicator lamp in the → Fig. 122 button lights up.

Activating the start/stop system manually:

1. Press the  button in the centre console again to activate the system manually once more → Fig. 122.

The instrument cluster shows the status of the start/stop system every time the  button is pressed.

If the start/stop system has switched the engine off, it will start again as soon as the system has been deactivated manually with the  button.

Always deactivate the start/stop system manually when driving through water.

#### Start-Stop mode with automatic Adaptive Cruise Control (ACC)

The engine will be switched off after the Adaptive Cruise Control (ACC) has brought the vehicle to a standstill → page 171 with an active braking intervention.

In the following instances, the engine will restart when the ACC is active:

- If the accelerator is depressed.
- When the Adaptive Cruise Control has resumed speed and distance control.
- If the vehicle ahead has moved on.

The engine will also be restarted if the Adaptive Cruise Control (ACC) is deactivated and the vehicle ahead moves further away.

### WARNING

Never switch off the engine while the vehicle is in motion. This can lead to a loss of vehicle control, accidents and serious injuries.

- The airbags and belt tensioners do not function.
- The brake servo does not work. More force is required on the brake pedal to stop the vehicle.
- The power steering does not work. More power is needed to steer.
- When you switch off the ignition, the steering column lock may engage and you will no longer be able to steer the vehicle.
- Always deactivate the start/stop system when working in the engine compartment.

### NOTICE

If the start/stop system is used in very high outside temperatures over a long period, the 12-volt vehicle battery can be damaged.

 The engine stop function may be deactivated automatically if the temperature is above around 38°C (100°F).

 In some cases, it may be necessary to restart the engine manually. Follow any corresponding messages on the instrument cluster display.

 The start/stop function is activated automatically if the Eco driving profile is selected on vehicles with driving profile selection → page 155.

 Always deactivate the start/stop system manually when driving through water. <

## Troubleshooting

### Engine no longer starts automatically

1. Start the engine manually → page 140.
2. Deactivating the start/stop system manually → page 144.
3. In this case, go to a correspondingly qualified workshop and have the system checked. Volkswagen recommends using a Volkswagen dealership. <

## Manual gearbox

### Manual gearbox: Selecting a gear

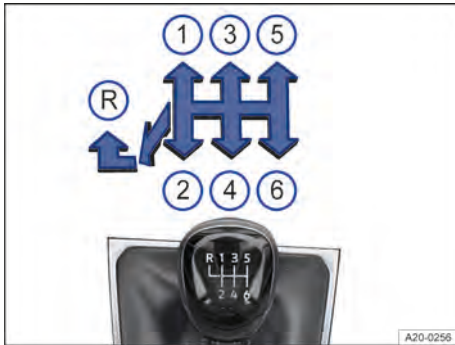

Fig. 123 Gear shift pattern of a 6-speed manual gearbox.

#### Selecting a forward gear

The positions of the individual gears are displayed on the gear lever.

1. Fully depress and hold the clutch pedal.
2. Move the gear lever to the required position → Fig. 123 ①.
3. Release pedal to engage the clutch.

In some countries, the clutch pedal will have to be depressed fully in order to start the engine.

#### Selecting reverse gear

Reverse gear should be selected only when the vehicle is stationary.

1. Fully depress and hold the clutch pedal.
2. Move the gear lever to the neutral position and push down.
3. Push the gear lever fully to the left and then forwards into the reverse gear position → Fig. 123 ②.
4. Release pedal to engage the clutch.

#### Shifting down

Shifting down while driving should always be done one gear at a time (to the next lower gear – and not at high engine speed). At high speeds or high engine speeds, damage to the clutch and the gearbox could occur if one or more gears are skipped when shifting down, even if the clutch is not released when doing this.

#### ⚠ WARNING

Shifting gears incorrectly to gears that are too low can lead to a loss of control over the vehicle, with accidents and serious injuries as a consequence.

#### ⚠ WARNING

Rapid acceleration can cause loss of traction and skidding, particularly on slippery roads. This can cause you to lose control of the vehicle, which can lead to accidents and serious injuries.

- Accelerate quickly only if visibility, weather, road and traffic conditions permit, and other road users are not put at risk due to the acceleration and driving style.
- Always adapt your driving style to the traffic.
- If you switch off TCS, the drive wheels may spin, especially if the road surface is wet, slippery or dirty. This may result in you no longer being able to steer or control the vehicle.

#### ⚠ WARNING

When the engine is running, the vehicle will start to move as soon as a gear is engaged and the clutch is released. This also applies when the electronic parking brake has been switched on.

- Never engage reverse gear while the vehicle is in motion.

#### ⓘ NOTICE

Serious damage to the clutch and gearbox could occur if the gear lever of the manual gearbox is shifted to a gear which is too low when travelling at high speeds or at high engine speeds. This also applies if the clutch remains depressed and the gears do not engage.

#### ⓘ NOTICE

Please note the following points in order to avoid damage and premature wear:

- Do not rest your hand on the gear lever when driving. The pressure from your hand is passed onto the selector forks in the gearbox.
- Ensure that the vehicle has come to a full stop before engaging reverse gear.
- Always fully depress the clutch pedal when changing gear.
- Do not hold the vehicle by “riding” the clutch on uphill gradients with the engine running.



Changing up a gear early will help to save fuel and minimise engine noise. <

## Troubleshooting

### ⚠ Clutch is “slipping”

The indicator lamp lights up yellow.

The clutch is not transmitting the full engine torque.

1. If necessary, remove foot from the clutch pedal.

### ⚠ Clutch overheated

The indicator lamp lights up yellow, an audible warning may sound and, if necessary, additional warning lamps and a text message may appear in the instrument cluster display.

The clutch can overheat, for example due to frequent starting.

1. You can continue to drive.

### ⚠ Clutch defective

The indicator lamp lights up yellow.

The clutch is faulty.

Drive on carefully!

1. In this case, go to a correspondingly qualified workshop immediately and have the system checked. Failure to do so can cause considerable clutch damage. Volkswagen recommends using a Volkswagen dealership.

With the DSG® dual clutch system with its two gear train halves, the engine power is always connected to one gear train half when driving. Before a gear shift, the next-higher or lower gear is already preselected in the load-free second gear train half. The clutch on the non-driven gear is then closed, and the other is opened at the same time. This makes very fast gear changes possible.

Thanks to its design, the DSG® dual clutch gearbox is more efficient than an automatic gearbox. Whereas in an automatic gearbox the torque converter is constantly in use, in the DSG® dual clutch gearbox the clutch can be opened at idling speed, thus saving fuel. Thanks to its efficiency, low weight and intelligent control system, the DSG® dual clutch gearbox usually enables fuel consumption that is equal to or lower than a manual gearbox.

However, just like the manual gearbox, the clutch in the DSG® dual clutch gearbox is subject to wear. Regular maintenance is necessary depending on the type of DSG® dual clutch gearbox; further information → page 353. In the event of a fault in one gear train half, the DSG® dual clutch gearbox also allows one gear train half to be deactivated and the journey to be continued using the other gear train half → page 151. The gearbox must then be checked as soon as possible by a correspondingly qualified workshop. Volkswagen recommends using a Volkswagen dealership.

## Automatic gearbox

### Function of the DSG® dual clutch gearbox

#### Description

The vehicle is equipped with a dual clutch gearbox DSG®.

The DSG® dual clutch gearbox is a gearbox that uses dual-clutch technology to change gear automatically. It uses a dual clutch and two gear train halves to enable very fast gear changes with no loss of torque. The DSG® dual clutch gearbox thus combines the performance and economy of a manual gearbox with the comfort and convenience of a conventional automatic gearbox.

#### Function

Engine power is transferred to the drive shaft via the gearbox. In order to change gears, the power transmission between the engine and the gearbox has to be interrupted. This is what the clutch is for.

### DSG® dual clutch gearbox: selecting a selector lever position

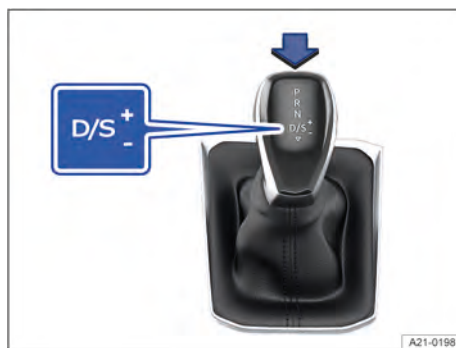

Fig. 124 Selector lever for dual clutch gearbox DSG with lock button (arrow).

The selected selector lever position will be shown in the instrument cluster display when the ignition is switched on.

### **P** – Parking lock

The drive wheels are blocked. May only be selected when the vehicle is stationary.

To disengage this selector lever position while the ignition is switched on, depress the brake pedal and press the lock button in the selector lever.

### **R** – Reverse gear

Reverse gear is selected. May only be selected when the vehicle is stationary.

### **N** – Neutral

The gearbox is in the neutral position. No force is transmitted to the wheels and the braking effect of the engine is not available.

### **D/S** – Standard forward driving position

Position **D**: Normal mode.

All forward gears are shifted up and down automatically. The timing of the gear shift is determined by the engine load, your individual driving style and the speed of the vehicle.

Position **S**: Sports programme.

The forward gears are automatically shifted up later and down earlier than in selector lever position **D**. This exploits the engine's full power reserves. The timing of the gear shift is determined by the engine load, your individual driving style and the speed of the vehicle.

To change between positions **D** and **S**, tap the selector lever to the rear ▽ → Fig. 124.

The selector lever will always move back into selector lever position **D/S**. This also functions in the Tiptronic gate → page 149.

### Selector lever lock

The selector lever lock in position **P** or **N** prevents gears from being engaged inadvertently, which would cause the vehicle to move.

To release the selector lever lock, switch on the ignition and depress the brake pedal. Then press the lock button in the selector lever handle in the direction of the arrow → Fig. 124.

The selector lever lock is not engaged if the selector lever skips position **N**, for example when shifting from reverse to **D/S**. This makes it possible, for instance, to "rock" the vehicle backwards and forwards to free the vehicle if it is stuck in snow or mud. The selector lever lock engages automatically if the brake pedal is not depressed and the lever is in position **N** for more than approximately 1 second and the vehicle is travelling no faster than approximately 5 km/h (3 mph).

### **WARNING**

Selecting the wrong position can cause you to lose control of the vehicle, which can lead to accidents and serious injuries.

- Never depress the accelerator when selecting a position.
- The vehicle will start moving if you release the brake pedal when the engine is running and a position is engaged.
- Never select reverse gear **R** while driving or engage the parking lock **P** while driving.

### **WARNING**

Unintentional vehicle movements can cause serious injury.

- The driver must never leave the driver seat when the engine is running and a position has been selected. If you have to leave the vehicle while the engine is running, always switch on the electronic parking brake and move the selector lever to position **P**.
- Hold the vehicle by the foot brake if the engine is running and the position **D/S** or **R** is engaged. The vehicle will "creep forward" even when the engine is idling, as power transmission is even then not fully interrupted.
- Never select reverse gear **R** or engage the parking lock **P** when the vehicle is in motion.
- Never leave the vehicle in selector lever position **N**. The vehicle will roll downhill irrespective of whether or not the engine is running.

### **NOTICE**

If the electronic parking brake is not switched on when the vehicle is stationary and the brake pedal is released when the parking lock **P** is engaged, the vehicle may move a few centimetres forwards or backwards.

 If the selector lever is moved accidentally to **N** when driving, take your foot off the accelerator. Wait for the engine to reach idling speed in the neutral position before selecting a position again.

 If the selector lever is not left in the parking lock position **P** for long periods when the engine is switched off, the 12-volt vehicle battery will discharge. ◀

## Changing gear using Tiptronic

Using Tiptronic, the gears can be shifted up and down manually in an automatic gearbox.

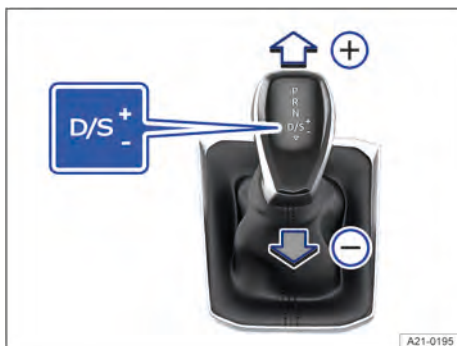

Fig. 125 Selector lever in Tiptronic position.



Fig. 126 Steering wheel with paddles for Tiptronic.

The gear that is currently selected will be maintained when the Tiptronic mode is selected. This remains the case as long as the system does not automatically carry out a change of gear due to the current driving situation.

### Operating Tiptronic with the selector lever

1. Push the selector lever from the selector lever position **D/S** to the right into the Tiptronic gate.
2. Tap the selector lever forwards **+** or back **-** to shift gear up or down → Fig. 125.

When tapping the selector lever in the Tiptronic gate, it is not necessary to press the lock button on the selector lever.

### Operating Tiptronic with the paddles

1. Pull the right paddle towards the steering wheel to change up a gear → Fig. 126.
2. Pull the left paddle towards the steering wheel to change down a gear.

3. To leave the Tiptronic mode, pull the right paddle towards the steering wheel for approximately 1 second.

The Tiptronic mode is automatically exited if the selector paddles are not operated for some time and the selector lever is not in the Tiptronic gate.

### NOTICE

When accelerating, the gearbox automatically shifts up to the next gear shortly before the maximum permitted engine speed is reached.

### NOTICE

When shifting down a gear manually, the gearbox will not change gear until the engine can no longer be overrevved.

## Driving with DSG® dual clutch gearbox

The gearbox changes the forward gears up and down automatically.

### Driving down hills

The steeper the downhill gradient, the lower the gear that must be selected. Lower gears increase the braking effect of the engine. Never allow the vehicle to roll down mountains or hills in the neutral position **N**.

1. Reduce your speed.
2. Push the selector lever from position **D/S** to the right into the Tiptronic gate → page 149.
3. Tap the selector lever to the rear to change down gear.

Or: shift down a gear using the paddles on the steering wheel → page 149.

### Stopping and pulling away on uphill gradients

The steeper the uphill gradient, the lower the gear you will need.

If you wish to stop the vehicle or pull away when driving uphill you should use the Auto Hold function → page 192.

When you stop the vehicle on an uphill gradient with a selected position, the vehicle must always be prevented from rolling by depressing the brake pedal or by applying the electronic parking brake. Do not release the brake pedal or switch off the electronic parking brake until you pull away → ⚠.

### Coasting with DSG® dual clutch gearbox

In coasting mode, the momentum of the vehicle can be used to save fuel in conjunction with an anticipatory driving style. The engine no longer brakes the vehicle – the vehicle can roll for a longer distance. The function is available only in the selector lever position **D/S** and at speeds of approximately 40 – 130 km/h (25 mph – 80 mph).

If you depress the brake when the vehicle is coming to a stop, the engine remains switched off until the vehicle is stationary.

When coming to a stop without braking, the engine restarts automatically at “creeping speed”.

An automatic engine start may take place in order to ensure reliable engine restarting and to guarantee the power supply of the vehicle electrical system.

### Initiating coasting

1. Select the **Eco** driving profile from the driving profile selection menu → page 156.
2. Take your foot off the accelerator. The engine will be disengaged and run at idling speed. The vehicle rolls without the braking effect of the engine.

### Cancelling coasting mode

1. Depress the brake pedal forcefully.  
**Or:** depress the accelerator or brake pedal briefly.  
**Or:** pull a paddle towards the steering wheel.  
**Or:** press selector lever to Tiptronic position.  
**Or:** change the driving profile from **Eco**, **Normal** or **Comfort**.

### Kickdown function

The kickdown function enables maximum acceleration in the selector lever position **D/S** or in the Tiptronic position.

If the accelerator is depressed fully, the gearbox will automatically shift to a lower gear, depending on the speed and engine speed. This will make use of the full vehicle acceleration.

With the kickdown function, the gearbox does not shift up to the next gear until the engine reaches the maximum engine speed for the gear.

When **Eco** driving profile is selected in vehicles with driving profile selection → page 156 and the accelerator is depressed fully beyond the pressure point, the engine output is automatically regulated to ensure maximum vehicle acceleration.

### Launch Control Program

Depending on equipment, vehicles with DSG® dual clutch gearbox have a Launch Control Program. The Launch Control Program gives the vehicle maximum acceleration from a standing start.

1. Switch off TCS → page 209.
2. Depress and hold the brake pedal with your left foot.
3. Move the selector lever to position **D/S** in gear **S** or to the Tiptronic position.  
**Or:** in vehicles with driving profile selection, select the **Sport** or **Race** driving profile → page 156.
4. With your right foot, depress the accelerator until the engine speed reaches approximately 3,200 rpm.
5. Take your left foot off the brake → . The vehicle will start with maximum acceleration.
6. Switch the TCS back on after acceleration.

### WARNING

Rapid acceleration can cause loss of traction and skidding, particularly on slippery roads. This can cause you to lose control of the vehicle, which can lead to accidents and serious injuries.

- Always adapt your driving style to the traffic.
- Use the kickdown function or fast acceleration only if visibility, weather, road and traffic conditions permit, and other road users are not put at risk due to the acceleration and the driving style.
- Please note that the driven wheels could start to spin and the vehicle could skid if the TCS is switched off, especially if the road is slippery.
- Switch on TCS again after acceleration.
- Use the Launch Control Program only if the road and traffic conditions allow for it.

### WARNING

Never “ride” the brake pedal or depress the brake pedal too often and for too long. Constant braking will cause the brakes to overheat. This can considerably reduce the braking effect, increase the braking distance and, in certain circumstances, cause the brake system to fail completely.

### NOTICE

- If you stop the vehicle on an incline while a position is selected, do not attempt to stop it from rolling back by depressing the accelerator. The DSG® dual clutch gearbox could overheat and be damaged.



- Never allow the vehicle to roll in selector lever position **N**, particularly if the engine is switched off. The DSG® dual clutch gearbox will not be lubricated and could be damaged.
- *Vehicles with Launch Control Program:* accelerating with the Launch Control Program places heavy strain on all vehicle components. This can lead to higher wear.

### ! NOTICE

Never let the brakes “rub” by applying light pressure to the brake when it is not necessary to brake. This will increase levels of wear.

## Troubleshooting

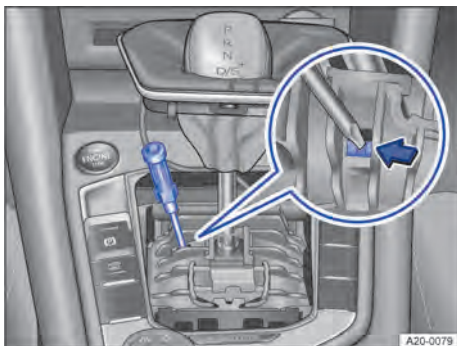

Fig. 127 Manually release selector lever lock (variant 1)

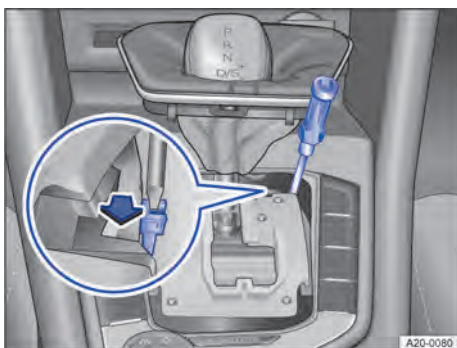

Fig. 128 Manually release selector lever lock (variant 2)

### 🚫 Engine does not start

The indicator lamp lights up green.

Brake pedal was not depressed, e.g. when trying to engage another position with the selector lever.

1. To select a position, press the brake pedal.

### 🚫 Lock button prevents you from driving off

The indicator lamp flashes green.

The lock button in the selector lever is not engaged.

1. Check whether the lock button is engaged.
2. Engage the lock button if necessary.

### 🚫 Selector lever lock prevents you from driving off

The indicator lamp flashes green. An information text is additionally displayed.

In rare cases, the selector lever lock may not engage in vehicles with a DSG® dual clutch gearbox.

The drive is then deactivated to prevent the vehicle from accidentally pulling away.

1. Depress the foot brake and then release it again.

### ⚠️ Gearbox overheated

The indicator lamp lights up yellow.

An acoustic signal may also be given. A text notification may also be shown on the instrument cluster display.

The DSG® dual clutch gearbox can become too hot, for example, if the vehicle pulls off regularly, during long periods at “crawling” speed, or in stop-and-go traffic.

### 🚫 Do not drive on!

1. Allow the gearbox to cool down while the parking lock **P** → ⓘ is engaged.
2. Do not drive on if the indicator lamp does not go out.
3. Seek expert assistance. Failure to do so could result in considerable damage to the gearbox.

### Releasing the selector lever lock manually

If the power fails in the vehicle (e.g. if the 12-volt battery is flat) and the vehicle has to be pushed or towed, the selector lever lock must be released manually. Seek expert assistance.

The manual release mechanism is located under the cover of the gearshift gate.

Removing the cover of the gearshift gate:

1. Switch on the electronic parking brake. If the electronic parking brake cannot be switched on, the vehicle will have to be prevented from rolling off using other means.
2. Switch off the ignition.

- Carefully pull the cover upwards in the area around the selector lever gaiter with connected electrical wiring → Fig. 127 or → Fig. 128.
- Pull the cover up and over the selector lever.

Releasing the selector lever lock manually:

- Push the release lever in the direction of the arrow → Fig. 127 or → Fig. 128 and hold it in this position.
- Press the lock button on the front of the selector lever handle and move the selector lever into position **N**.
- After manual unlocking, carefully press the cover into the centre console while ensuring that the electrical wires are positioned correctly.

### Emergency mode

There is a fault in the system if all the displays on the instrument cluster for the selector lever positions have a light background. The DSG® dual clutch gearbox is running in an emergency mode. The vehicle can still be driven in the emergency mode, but only at reduced speed and not in all gears.

In vehicles with a DSG® dual clutch gearbox, you may no longer be able to select reverse gear.

In all cases, you should have the DSG® dual clutch gearbox checked by a correspondingly qualified workshop immediately. Volkswagen recommends using a Volkswagen dealership.

### Vehicle does not move even though position is engaged

If the vehicle will not move in the required direction, the system may have selected the position incorrectly.

- Depress the brake pedal and reselect the position.
- If the vehicle still does not move in the required direction, there is a system fault. Seek expert assistance and have the system checked.

### WARNING

Never release the parking lock **P** when the electronic parking brake is switched off. Otherwise the vehicle could move unexpectedly if it is stopped on an incline, which could lead to accidents and serious injuries.

### NOTICE

If you allow the vehicle to roll for an extended period or at high speed with the engine switched off and with the selector lever in the **N** position, the DSG® dual clutch gearbox will be damaged (e.g. when being towed).

### NOTICE

- Park the vehicle in a safe place immediately or drive faster than 20 km/h (approx. 12 mph) when the warning that the gearbox is overheated is displayed for the first time.
- Park the vehicle in a safe place immediately and switch off the engine if the text message and acoustic warning are repeated around every 10 seconds. Allow the gearbox to cool down.
- Continue driving only when the acoustic warning is no longer emitted in order to avoid damage to the gearbox. You should not pull away or drive the vehicle at very low speeds while the gearbox is overheated.

## Driving on uphill gradients

### Hill Start Assist

The Hill Start Assist function actively holds the vehicle when pulling away on an incline.

#### Functional requirements

The following prerequisites need to be met simultaneously:

- On an incline, the stationary vehicle must be held in position with the foot brake until the vehicle starts moving.
- The engine is running “smoothly”.
- A gear, or a gear selector position, is engaged for driving uphill.

To move off, remove your foot from the brake pedal and depress the accelerator immediately. The brake will gradually be released as the vehicle pulls away.

 The hold function of the Hill Start Assist only remains active for a short time. Start driving within about 2 seconds.

#### Function conditions

Hill Start Assist will be deactivated immediately if one of the conditions listed below is no longer met:

- If the driver door is opened.
- If the engine is not running smoothly or there is an engine fault.
- If the engine is switched off or has stalled.
- If the selector lever is the neutral position **N**.

## CAUTION

If you do not drive off immediately after releasing the brake pedal, the vehicle may roll backwards.

- In this case, depress the brake pedal immediately or switch on the electronic parking brake.
- Depress the brake pedal immediately or switch on the electronic parking brake if the engine stops.
- Depress the brake pedal for a few seconds before moving off if you want to prevent the vehicle from rolling backwards when driving off on an uphill gradient in dense traffic.

## Downhill speed control

The downhill speed control system helps when braking and travelling downhill in vehicles with a DSG® dual clutch gearbox. The downhill speed control uses the braking power of the engine.

The dual clutch gearbox DSG® selects the best gear depending on the steepness of the gradient and the current speed. The selector lever must be in selector lever position **D/S** for this purpose. The downhill speed control system is not active in Tiptronic mode.

As the downhill speed control can shift down only as far as third gear, it may be necessary to activate the Tiptronic mode when driving down particularly steep inclines. In order to use the braking effect of the engine and relieve the load on the brakes, shift manually to second or first gear in Tiptronic mode.

The start/stop system is automatically deactivated as long as downhill speed control is active.

### Activating downhill speed control automatically:

- If the downhill gradient is greater than approximately 6%.
- **And:** if the selector lever is in position **D/S**.
- In addition, if the cruise control system (CCS) is switched off: if the vehicle speed is less than approximately 80 km/h (50 mph).  
**Or:** the brake is pressed.
- In addition, if the cruise control system is active: if the stored speed is exceeded.
- In addition, if Adaptive Cruise Control (AAC) is switched off: if the vehicle speed is less than approximately 80 km/h (50 mph).  
**Or:** the brake is pressed.

- In addition, if Adaptive Cruise Control (ACC) is active: if the stored speed is exceeded.

### Deactivating downhill speed control automatically:

- If the downhill gradient becomes less steep.
- **Or:** if the gearbox shifts up a gear because the engine speed is higher than approximately 4,500 rpm.
- **Or:** in addition, if the cruise control system is active: if the stored speed can be maintained.
- **Or:** in addition, if Adaptive Cruise Control (ACC) is active: if the stored speed can be maintained.

## WARNING

The intelligent downhill speed control technology cannot overcome the laws of physics, and functions only within the limits of the system. Never let the extra convenience afforded by downhill speed control tempt you into taking any risks when driving.

- Unintentional vehicle movements can cause serious injury.
- The downhill speed control cannot replace the full concentration of the driver.
- Ensure that your speed and driving style are always appropriate for the current visibility, weather and road/traffic conditions.
- The downhill speed control cannot hold the vehicle on the gradient in all situations or brake it sufficiently on all slopes going downhill (e.g. if the ground is slippery or icy).

## WARNING

Always be prepared to brake the vehicle. Accidents and injuries could occur if this is not ensured.

- The downhill speed control is only a support function and may not be able to brake the vehicle sufficiently in all situations when driving downhill.
- The vehicle may become faster despite the downhill speed control being in operation.

## Hill Descent Control

When the Hill Descent Control is active, the indicator lamp  lights up green.

When the Hill Descent Control is not active, the indicator lamp  lights up grey. The system is switched on, but is not regulating.

Hill Descent Control initiates an automatic braking intervention on all four wheels to limit the speed

when driving forwards and reversing on steep slopes. The wheels are prevented from locking as the anti-lock brake system remains active.

If you enter a downhill slope travelling at a speed under 30 km/h (19 mph), the vehicle speed will be limited to a minimum of 2 km/h (1 mph) and a maximum of 30 km/h (19 mph). The driver can use the accelerator pedal and the brakes to alter the speed within this range.

However, a prerequisite for this is that the tyres have sufficient grip on the driving surface. Hill Descent Control cannot work on an icy or slippery slope, for example.

Hill Descent Control is automatically activated if the following conditions are met:

- The engine is running.
- The speed is under about 30 km/h (about 19 mph)
  - the function display  is shown on the instrument cluster display.
- The downhill gradient is at least 10 %.
- You do not brake or accelerate.

Hill Descent Control is deactivated if the speed exceeds about 30 km/h (about 19 mph), if the driver brakes or accelerates or if the downhill gradient is less than 5%.

### WARNING

The intelligent Hill Descent Control technology cannot overcome the laws of physics, and functions only within the limits of the system. Never let the extra convenience afforded by Hill Descent Control tempt you into taking any risks when driving.

- Unintentional vehicle movements can cause serious injury.
- The Hill Descent Control cannot replace the full concentration of the driver.
- Ensure that your speed and driving style are always appropriate for the current visibility, weather and road/traffic conditions.
- Hill Descent Control may not be able to hold the vehicle on all gradients or brake it sufficiently on all slopes going downhill (e.g. if the ground is slippery or icy).

### WARNING

Always be prepared to brake the vehicle. Accidents and injuries could occur if this is not ensured.

- The Hill Descent Control system is only a support function and may not be able to brake the vehicle sufficiently in all situations when driving downhill.

- The vehicle may accelerate despite the Hill Descent Control system.

## Steering

### Information on steering

The steering should be locked every time you leave the vehicle to make it more difficult for the vehicle to be stolen.

#### The steering

The power steering provided by the electromechanical steering system automatically adjusts to the vehicle speed, steering torque and steering angle of the wheels. The electromechanical steering only functions when the engine is running. The steering also functions when the start/stop system intervenes and switches off the engine.

You will need considerably more strength than normal to steer the vehicle if the power steering is reduced or has failed completely.

In vehicles with driving profile selection, the selected driving profile can affect the behaviour of the power steering.

#### Electronic steering column lock in vehicles with a starter button

The steering column is locked electronically in vehicles with a starter button:

1. Stop the vehicle. Move the selector lever to position **P** if necessary.
2. Switch off the ignition and then open the driver door. The steering column is locked.

If you do **not** want the steering column to be locked, first open the driver door and then switch off the ignition. The steering column will remain unlocked as long as the vehicle is not locked.

#### Mechanical steering column lock

The steering column is locked mechanically in vehicles with an ignition lock:

Locking the steering column:

1. Stop the vehicle. Move the selector lever to position **P** if necessary.
2. Remove the vehicle key.
3. Turn the steering wheel slightly until the steering lock audibly engages.

Unlocking the steering column:

1. Turn the steering wheel slightly to relieve the load on the steering lock mechanism.

2. Insert the vehicle key into the ignition lock.
3. Hold the steering wheel in this position and turn the ignition on.

### Counter steering assistance

Counter steering assistance provides the driver with power steering in critical driving situations. Additional steering power helps the driver when counter steering → .

### Progressive steering

Depending on the vehicle equipment, progressive steering can adjust the required steering movement to the driving situation. Progressive steering only functions when the engine is running.

In *urban traffic*, less steering input is required when parking, manoeuvring, or turning sharply.

When driving on *country roads* or on the *motorway*, the progressive steering provides a more sporty, direct steering response, and a dynamic feel.

### WARNING

Steerability is greatly reduced by a heavy steering wheel if the power steering is not working, and this can cause loss of control of the vehicle, accidents, serious injuries and death.

- Depending on the vehicle equipment level, the power steering functions only when the engine is running.
- Never allow the vehicle to roll if the engine is switched off.
- Never remove the vehicle key from the ignition if the vehicle is in motion. The steering column lock may be activated and it will no longer be possible to steer the vehicle.

### WARNING

In conjunction with the ESC, counter steering assistance provides the driver with assistance when steering in critical driving situations. The driver must steer the vehicle at all times. Counter steering assistance does not steer the vehicle.

### NOTICE

Switch on the ignition when the vehicle is towed so that the turn signals, horn, wipers and window washer system can be used.

## Troubleshooting

### Steering fault

The warning lamp lights up or flashes red.

There is a fault in the electromechanical steering or electronic steering column lock.

#### Do not drive on!

1. Seek expert assistance.
  - If the warning lamp lights up red, the steering may be stiff because the electromechanical steering has failed.
  - If the warning lamp flashes red, it is not possible to unlock the steering column.

### Steering fault

The indicator lamp lights up or flashes yellow.

The steering is harder or more sensitive than usual.

The indicator lamp lights up continuously:

1. Re-start the engine and drive a short distance slowly.
2. If the warning lamp stays lit, the system should be checked by a suitably qualified workshop. Volkswagen recommends using a Volkswagen dealership.

The indicator lamp flashes:

1. Turn the steering wheel to and fro.
2. Switch the ignition off and then on again.
3. Observe the messages on the instrument cluster display.
4. Do not continue your journey if the indicator lamp still flashes after the ignition is switched on. Seek expert assistance.

## Driving profile selection and 4MOTION Active Control

### Introduction to the topic

By selecting different driving profiles, the driver can adapt the characteristics of the vehicle systems to the current driving situation, the desired ride comfort and an economical driving style. The adaptable vehicle systems include the chassis, steering, drive and the air conditioning system.

Different driving profiles are available, depending on the vehicle equipment level. The effect on the vehicle systems in the individual driving profiles depends on the vehicle equipment level.

#### Differentiation by powertrain type

Only vehicles with all-wheel drive have a rotary switch for 4MOTION Active Control.

#### Vehicles with adaptive chassis control (DCC)

The adaptive chassis control (DCC) continuously adjusts the chassis damping to the current road surface and driving situation while the vehicle is in motion. DCC incorporates the chassis tuning of the selected driving profile.

#### Vehicles with R Performance rear axle differential with dynamic torque distribution

Depending on the vehicle equipment level, the R Performance rear axle differential with dynamic torque distribution is available for R models. In order to achieve greater traction when cornering, the system can distribute more torque to the wheel on the outside of the bend. The system also uses the chassis setup of the selected driving profile for this.

 Some settings can be stored in the user accounts of the personalisation function and therefore change when the user account changes → page 41.

### Selecting a driving profile



**Fig. 129** In the centre console: MODE button for driving profile selection.

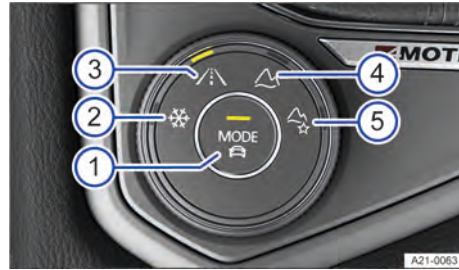

**Fig. 130** In the centre console: rotary switch for 4MOTION Active Control.

- ① MODE button: select onroad driving profiles and open menu in the Infotainment system.
- ② Snow driving profile.
- ③ Onroad driving profile.
- ④ Offroad driving profile.
- ⑤ Offroad Individual driving profile.

The driving profile can be selected when the ignition is switched on and when the vehicle is stationary or while driving.

#### WARNING



Selecting a driving mode while the vehicle is in motion can distract you from the road and cause accidents.

- Drive with your full attention and with responsibility.

If you have selected a driving profile while driving, the vehicle systems will be switched immediately to the new driving profile except for Drive.

1. To activate the newly selected driving profile for the Drive system also, take your foot off the accelerator as soon as permitted by the traffic situation.

#### Selecting the driving profile via the MODE button

1. Press  → Fig. 129.
2. To select driving profiles, press  again or tap the desired driving profile in the Infotainment system.

If the Normal driving profile is selected, the LED in the MODE button will remain switched off, depending on the version.



#### Selecting driving profile by means of rotary switch

1. Turn the rotary switch until the LED lights up next to the desired driving profile → Fig. 130.

- To switch to the onroad driving profiles, press the  button → Fig. 130 ① or tap **Onroad driving profile** in the Infotainment system.

### Selecting a driving profile using the button on the multifunction steering wheel

The  button on the multifunction steering wheel is available on R models, depending on the vehicle equipment.

- Lightly press .
- To select driving profiles, lightly press  again.  
**Or:** to select the **Race** driving profile, strongly press .

### Displaying information on the driving profile

- To display further information on the selected driving profile, tap  in the Infotainment system.

### Selecting the Individual driving profile

- Press .  
**Or:** turn the rotary switch until the LED lights up next to the **Onroad** driving profile.
- Select **Individual** in the Infotainment system.
- To open the **Individual** menu, tap **Change**.

### Selecting the Offroad Individual driving profile

- Turn the rotary switch until the LED lights up next to the **Offroad Individual** driving profile.  
**Or:** if the **Offroad Individual** driving profile is already selected, press the  button on the rotary switch → Fig. 130 ①.
- To open the **Individual** menu, tap **Change** in the Infotainment system. <

## Characteristics of the driving profiles

 The **Eco** driving profile switches the vehicle into economical mode and helps you to drive the vehicle in a fuel-efficient manner. The system automatically switches to gear position E when the **Eco** driving profile is selected.

 The **Comfort** driving profile creates a comfort-oriented vehicle setup and is suited to long journeys, for example. In R models, the **Comfort** driving profile switches the vehicle into economical mode.

The gearbox switches automatically to position E.

The **Comfort** driving profile is available only for vehicles with DCC.

 The **Normal** driving profile corresponds to the basic settings of the vehicle systems and offers a balanced setup, e.g. for everyday use.

 The **Sport** driving profile gives you a sporty driving feeling. If you select the **Sport** driving profile, position S will be selected on vehicles with an automatic gearbox. In R models, the **Sport** driving profile corresponds to the basic settings of the vehicle systems. In R models with automatic gearbox, position D will be selected.

 The **Race** driving profile is available only for sporty special editions of the vehicle, depending on the equipment. This profile provides you with a very sporty driving feeling. If you select the **Race** driving profile, the damping of the running gear will be adjusted to a hard setting, and position S will be selected on vehicles with an automatic gearbox.

 You can use the **Individual** driving profile to tailor individual vehicle systems to suit your personal requirements.

### Additional driving profiles for 4MOTION Active Control

 Under **Onroad**, you can choose between **Eco**, **Comfort**, **Normal**, **Sport** and **Individual** driving profiles.

Under **Onroad** in R models, you can choose between **Comfort**, **Sport**, **Race** and **Individual** driving profiles.

 The **Offroad** driving profile makes it easier to control acceleration with the accelerator when driving offroad. The braking action of the engine is always available and gearshifts can be prevented in critical situations. Hill Start Assist and Hill Descent Control are active in the **Offroad** driving profile. The dynamic cornering light is adjusted to provide better support in poor visibility.

 The **Offroad Individual** driving mode is an enhanced version of the offroad driving profile that you can adapt to your individual requirements.

 The **Snow** driving profile can be used to improve grip on icy or snowy roads through more targeted power transmission.

When an offroad driving profile is selected, information is shown in the instrument cluster display.

### NOTICE

Using 4MOTION Active Control driving profiles can cause tyre wear, increased fuel consumption and additional noise during normal driving.

## Standard behaviour of the driving profiles and vehicle systems

The **Normal** driving profile corresponds to the basic settings of the vehicle systems when the ignition is switched on.

In R models, the **Sport** driving profile corresponds to the basic settings of the vehicle systems when the ignition is switched on.

### Behaviour of the driving profiles when the ignition is switched off and on

If you switch the ignition off and then back on again, the previously selected driving profile remains selected.

In R models, the **Sport** driving profile will be selected if you switch the ignition off and then back on again.

If you have previously selected the driving profile **Snow**, **Offroad** or **Offroad Individual** and switch the ignition off and then back on again, the last-selected onroad driving profile will be set.

### Behaviour of the Drive vehicle system when the ignition is switched off and on

The settings of the **Drive** vehicle system are reset to the settings of the **Normal** driving profile as soon as you switch the ignition off and on again.

The other vehicle systems retain their settings.

You can switch the **Drive** vehicle system to the desired driving profile again.

1. Select the desired driving profile again.

In R models, the settings of the **Drive** vehicle system will be reset to the settings of the **Sport** driving pro-

file as soon as you switch the ignition off and on again.

## Troubleshooting

### Fault in the adaptive chassis control (DCC)

The indicator lamp lights up yellow.

The message **Fault: damper** may be displayed on the instrument cluster display.

1. In this case, go to a correspondingly qualified workshop and have the system checked. Volkswagen recommends using a Volkswagen dealership.

### All-wheel drive fault

The indicator lamp lights up yellow.

The rear axle differential may be overheated.

The message **All-wheel drive not working. You can drive on. Please visit workshop.** may be displayed in the instrument cluster display.

1. Stop the vehicle for around 10 minutes and then continue your journey with an adapted speed and driving style.
2. If the fault persists, go to a correspondingly qualified workshop. Volkswagen recommends using a Volkswagen dealership.

### Position S cannot be selected

It is not possible to select the position **S** in the **Offroad** and **Snow** driving profiles. When an offroad driving profile is selected, information is shown in the instrument cluster display.

1. Select a different driving profile in order to be able to select the position **S**.

### The driving profiles or vehicle systems do not behave as expected.

1. Note the standard behaviour of the driving profiles and vehicle systems → page 158.



## Offroad display



Fig. 131 In the Infotainment system: offroad display.

The offroad display contains digital instruments that show additional information about the vehicle and its surroundings. This makes it possible to assess the current driving situation more precisely.

### Opening the offroad display

1. Press the **MENU** button in the Infotainment system.
2. Tap the **Vehicle** function button.
3. Tap the **Selection** function button.
4. Tap the **Offroad** function button.

### Selecting instruments and setting units

The Infotainment system shows various instruments → Fig. 131.

1. To change instruments, swipe vertically over the display.

The units of measurement can be adjusted for some instruments in the Infotainment system → page 37.

### Instruments in the offroad display

The options for selecting instruments depend on the vehicle equipment.

- **Compass:** the compass shows the current driving direction.

- **Steering angle display:** the steering angle of the vehicle is displayed. The value is positive for a left steering angle and negative for a right steering angle.
- **Altimeter:** the altimeter shows the current height above sea level.
- **Coolant temperature display:** the display corresponds to the temperature display on the instrument cluster.
- **Oil temperature display:** the display corresponds to the oil temperature display on the instrument cluster.

### Adapting the display areas to the driving situation

The instruments displayed can be selected depending on the driving situation, the environmental conditions and the offroad conditions:

- **Sandy terrain:** oil and coolant temperature display, steering angle display.
- **Inclines:** steering angle display, coolant temperature display, altimeter (country-dependent).
- **Alpine terrain:** steering angle display, altimeter (country-dependent), compass

## Offroad driving

### Introduction to the topic

The example stated in this chapter must be understood as general guidelines that are intended to help the driver to drive safely when driving offroad. However, it is not possible to predict whether these guidelines will be valid for all situations that could occur. Before driving in unknown terrain, it is crucial to obtain knowledge about the characteristics of the terrain ahead. This will enable you to assess potential danger in advance. The driver is responsible for deciding whether the vehicle is suitable for the terrain in question and whether it is possible to drive across the terrain.

Driving offroad demands different skills and driving styles in comparison to driving on roads.

The vehicle is not built for "expedition-type" travel.

The driver can use 4MOTION Active Control to activate a variety of vehicle settings in an all-wheel drive vehicle as required → page 156.

Switch off the driver assist and parking systems when driving offroad.

#### Checklist

Before using the vehicle offroad for the first time, the following steps should be taken in order to be able to drive and control the vehicle away from surfaced roads:

- ✓ Observe the general safety notes for driving offroad → page 160.
- ✓ Adjust the seat position so that you have a good view to the front. Fasten seat belts → page 43.
- ✓ Always wear suitable, well-fitting shoes that provide good grip for your feet when using the pedals.

 A responsible driver should respect the environment when driving offroad. Remember that driving through undergrowth and on meadows can destroy animal and plant habitats.

 Leaking service fluids due to vehicle damage can pollute the environment. Spilt service fluids must be collected and disposed of properly and with respect for the environment.

 Take suitable accessories and equipment with you when driving offroad. ◀

### Safety notes for offroad driving

📖 Please refer to  and  on page 160.

#### WARNING

The intelligent technology of the vehicle cannot overcome the laws of physics, and functions only within the system limits. Despite input from the ABS, adverse terrain can cause instability through locked wheels – for example if you brake hard when driving on loose gravel. The activated ESC will have difficulty stabilising the vehicle in these circumstances.

#### WARNING

Driving offroad can be dangerous and could cause accidents, serious injury, damage to the vehicle and also a vehicle breakdown far from any assistance.

- Never choose a dangerous route or take a risk that endangers you and the vehicle occupants. If it is not possible to drive on or if you have any doubts about the safety of the route, turn round and choose a different route.
- Even terrain that looks harmless can be difficult and dangerous, and could get you and your passengers into difficulties. Explore the terrain on foot first.
- Drive particularly carefully and think ahead when driving offroad. If you drive too fast or if a driving manoeuvre is unsuccessful, this could result in serious injuries and vehicle damage.
- Never drive faster than the current terrain, road conditions, traffic and weather allow.
- Never drive too fast over embankments, ramps or slopes. This can lead to the vehicle losing contact with the ground so that you can no longer steer and lose control of the vehicle.
- If the vehicle does lose contact with the ground, always point the front wheels straight ahead. If the wheels are not pointing straight ahead when the vehicle lands, it could roll over.

#### WARNING

Sports utility vehicles are subject to a considerably higher risk of rolling over than normal road passenger vehicles → page 161.

- In the event of an accident, vehicle occupants not wearing seat belts are subjected to a considerably higher risk of fatal injury than those wearing seat belts.

- The vehicle has a higher centre of gravity and is more prone to rolling over than a "normal" passenger car which is unsuited for offroad driving.
- Never drive too fast, particularly through bends, or perform extreme driving manoeuvres.
- Always adjust your speed and driving style to suit the terrain conditions.
- Luggage and other items transported on the roof of the vehicle raise the centre of gravity and will make the vehicle more likely to roll over.

### ⚠ WARNING

The terrain might look harmless, but there could be hidden dangers. Potholes, hollows, ditches, precipices, obstacles, shallows, soft and boggy surfaces are often not recognisable as such and can be covered either fully or partly by snow, water, grass or branches lying on the ground. Driving offroad over such terrain could cause accidents, serious injury and also a vehicle breakdown.

- Check any unknown sections of the route on foot carefully before driving through them.
- Never choose an unsafe route or take a risk which could endanger you or your passengers. If you have any doubts about the safety of the route, turn round and choose a different route.
- Always adjust your speed and driving to match vehicle load levels and terrain, visibility and weather conditions.

### ⚠ WARNING

- Always avoid traversing a slope → page 166.
- Never leave the vehicle via the doors facing down the hill when the vehicle is stopped sideways on a steep hill. The combined centre of gravity of the vehicle and its payload (vehicle occupants and payload) can shift and cause the vehicle to roll over and roll down the incline. Always leave the vehicle calmly via the doors which open towards the upward incline → page 166.

### ⚠ WARNING

The driver assist systems were designed for use on surfaced roads only. The driver assist systems are not suited to driving offroad and therefore may even be dangerous. Using the driver assist systems when driving offroad could cause you to lose control over the vehicle and sustain severe injuries.

- Never use the driver assist systems when driving offroad.

### ⚠ WARNING

Driving the vehicle when the fuel level is too low could lead to your vehicle breaking down offroad, accidents and serious injuries.

- Fill up with sufficient fuel before driving offroad.
- The steering and brake support systems will not function if the engine sputters or stops completely due to a lack of fuel or irregular fuel supply.

### ⓘ NOTICE

Any rain entering the vehicle when the windows or glass roof are open can soak the interior equipment and cause damage to the vehicle. Always keep the windows and glass roof closed when driving offroad. <

## Explanation of technical terms

📖 Please refer to ⚠ and ⓘ on page 160.

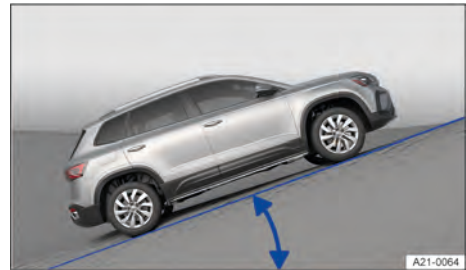

Fig. 132 Illustration: gradient angle.

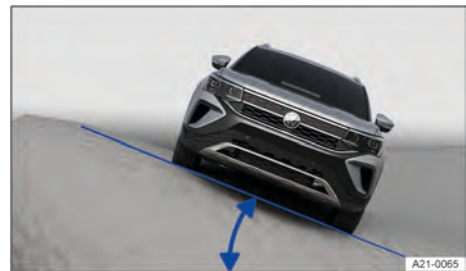

Fig. 133 Illustration: inclination angle.

**Centre of gravity** The centre of gravity of a vehicle influences its propensity to roll over. The vehicle has a higher ground clearance and therefore a higher centre of gravity than "normal" road vehicles so that it can be driven offroad. The higher centre of gravity

means that there is a greater danger of roll-over when driving. Always remember this fact when driving and follow the safety tips and warnings given in this owner's manual.

**Ground clearance** This is the vertical distance between the road surface and the lowest point on the vehicle underbody.

**Gradient** Indication of gradient that the vehicle can drive up under its own power. The difference in altitude (ascent) made over a distance of 100 m (330 ft) is given in percent or degrees → Fig. 132. The maximum gradient angle that the vehicle can overcome depends among other things on the road surface and engine power.

**Inclination** Maximum angle at which the vehicle may be driven across a slope without the vehicle tipping over (dependent on the centre of gravity) → Fig. 133.

**Breakover angle** Maximum permitted angle given in degrees that a vehicle driven at low speed can drive over a ramp without the underbody of the vehicle touching the ramp.

**Ramp angle** Transition from the horizontal level surface to a gradient, or from a gradient back to the level surface. Maximum permitted angle given in degrees that a vehicle can clear a ramp without the underbody of the vehicle touching the ramp.

**Fall line** This is the vertical drop route.

**Articulation** The vehicle's torsional flexibility when driving over objects with just one side of the vehicle.

- ✓ Check engine oil level and refill engine oil as necessary. Oil will still reach the engine even when the vehicle is tilted only if the engine oil level is sufficient.
- ✓ Completely refill the washer fluid reservoir with water and washer fluid.
- ✓ Stow luggage in the vehicle as evenly and as low as possible. Secure all loose items.

## General rules and driving tips

📖 Please refer to ▲ and Ⓞ on page 160.

- Volkswagen recommends never driving offroad alone. You should drive offroad with at least two offroad vehicles driving as a team. Unexpected situations can always occur. We recommend that you carry equipment you can use for calling for help.
- Stop your vehicle when you reach difficult sections and check the route ahead on foot.
- Drive slowly over the crests of hills so the vehicle does not lose contact with the ground, become damaged and possibly leave you unable to manoeuvre.
- Drive slowly when the route is difficult. Shift up a gear when on slippery ground and always keep the vehicle in motion.
- The ground is predominantly soft when driving offroad meaning the tyres could sink into the ground. This will reduce ground clearance and the wading depth. If possible, always drive on flat and firm ground.
- Even when driving at low speeds, always keep your distance from other vehicles. If the first vehicle suddenly gets stuck, the following vehicle can stop without getting stuck.

## Checklist "Before driving offroad"

📖 Please refer to ▲ and Ⓞ on page 160.

### Checklist

To ensure your own safety and the safety of your passengers, observe the following points before driving offroad:

- ✓ Inform yourself sufficiently about the nature of the terrain ahead before you drive into the terrain.
- ✓ Fill the tank up to the maximum capacity. Fuel consumption is considerably higher offroad.
- ✓ Check whether the tyre tread of all tyres and the tyre type are suitable for the planned off-road trip.
- ✓ Check and adjust the tyre pressure for all tyres.

### ! NOTICE

- Always ensure that there is enough ground clearance underneath the vehicle. Serious damage to the underbody could occur if the vehicle bottoms. This damage could cause the vehicle to break down and thus make it impossible to drive on.
- Do not ride the clutch or rest your foot on the clutch when driving offroad. When travelling over uneven ground, you could press the clutch by mistake and lose control of the vehicle. This also prevents power being transferred between the engine and the gearbox. In addition, driving with the clutch partially engaged causes premature wear to the clutch lining.

## Changing gear correctly

📖 Please refer to ⚠️ and ⓘ on page 160.

The choice of gear depends on the terrain.

Before attempting to drive through difficult terrain it can be helpful to stop and consider which gear you should select. After several trips offroad, you will learn which gear to select in conjunction with the step-down ratio for different types of terrain.

- With the correct gear selected, the vehicle will normally not have to be braked so much using the foot brake when driving downhill as the engine braking effect will normally be sufficient.
- You should only depress the accelerator as much as is required. If you accelerate too hard, the wheels could spin and you could lose control of the vehicle.
- Select position **D** when driving in normal, flat off-road terrain.
- Adjust your speed when driving on soft or slippery ground, and select the highest suitable position for the Tiptronic.
- On steep downhill or uphill gradients, select position **1** for the Tiptronic.
- When driving through mud, sand, water or hilly terrain, drive with the Tiptronic in positions **3** or **2** → page 147.
- Use the offroad display → page 159.
- Use the Auto Hold function → page 192.

## Driving on rough terrain

📖 Please refer to ⚠️ and ⓘ on page 160.

1. Select a suitable driving profile → page 156 and drive through rocky terrain no faster than walking pace.
2. If you are not able to drive around a rock, drive carefully onto the rock with one front wheel and drive over it slowly → ⓘ.

Even obstacles that are smaller than the available ground clearance could come into contact with the vehicle underbody and thus cause damage which could lead to a vehicle breakdown. This applies in particular if there is a ditch or soft ground either in front of or behind the obstacle. This also applies in cases when you drive too quickly over the obstacle causing the vehicle to bounce.

## ⓘ NOTICE

You should never drive centrally over large obstacles, e.g. boulders or tree stumps, or drive over such obstacles with one side of the vehicle. Obstacles which require more ground clearance than is available could damage vehicle components when driving over them and thus cause the vehicle to break down. <

## Driving through standing or flowing water

📖 Please refer to ⚠️ and ⓘ on page 160.

Driving through flooded terrain or bodies of water could damage the vehicle.

It is possible to carefully drive the vehicle through water levels up to the lower edge of the body.

1. Observe the maximum fording depth of the vehicle.
2. When driving through water, always select a section where the ground is solid and where the depth of the water does not exceed the maximum permitted fording depth of the vehicle.
3. Observe further information on driving through water on roads → page 136.

### Before driving through water

< Stop the vehicle, get out and assess the situation → ⚠️:

1. Measure the depth of the water to the other side. Ensure that the ground is firm enough and also watch out for underwater hollows and obstacles → ⓘ.
2. Make sure that it is possible to drive into and out of the water safely.
3. Check the ramp angle and the firmness of the ground on the banks.
4. Select a suitable driving profile → page 156.

### Driving through standing or slow-moving water

If the ground is firm enough, your vehicle can be driven through standing and slow-moving water → ⚠️.

1. Drive slowly into the water following the direction of flow. Never exceed the ramp and inclination angles.
2. Drive at constant speed to the opposite bank.

Driving with a constant speed makes it possible to avoid engine damage due to ingress of water. It also enables an air pocket to form in front of the engine

which supplies the necessary oxygen to the engine. You will create a bow wave in front of the vehicle if you drive at speed into or through the water. This bow wave could get into the engine air intake duct and seriously damage the engine.

### Driving through fast-flowing water

The force, speed and depth of the water can be unpredictable and dangerous → . The vehicle can be swept away by the water. Even vehicles with greater ground clearance can get stuck if the ground under the vehicle is swept away. Flowing water builds up at one side of the vehicle, making it deeper at that point.

Do not take any risks. Find a calmer place to cross through the water or turn round.

### After driving through water

1. Check the vehicle for damage.
2. Dry the brakes using careful braking manoeuvres.

### WARNING

Strong flowing water can develop enormous power and sweep the vehicle away. This can lead to very dangerous situations which can cause accidents and serious or even fatal injuries.

- Never stop the vehicle in water.
- Soft ground surfaces, underwater obstacles and shallows or water in the engine compartment can cause accidents and can cause the vehicle to breakdown in the water. This could lead to critical situations.

### NOTICE

If you drive through water, parts of the vehicle, such as the engine, drive train, running gear and vehicle electrics, could sustain severe damage.

- Never drive over salt or salt flats or through salt water. Salt can cause corrosion. Immediately rinse all vehicle parts that have come into contact with salt or salt water using fresh water.

### NOTICE

Objects in the water can enter the openings of the extended washer jets of the headlight washer system. The washer jets cannot then be retracted to their initial position.

- Do not use the headlight washer system when driving through water.

## Driving in sand and mud

 Please refer to  and  on page 160.

ESC and TCS must be switched on → page 207.

1. Select a suitable driving profile → page 156.
2. Select a suitable gear and remain in this gear until you have reached more solid ground → page 163.
3. Always drive at a steady speed through sand or mud, do not make any manual gear changes and do not stop.

The tyres can lose their traction when driving through sand or mud.

- Do not change speed or direction.
- If the vehicle slides, steer in the direction needed to get the vehicle under control.
- If the tyres have lost their grip, turn the steering wheel back and forth quickly. This will briefly give the front wheel tyres better grip for these ground conditions.

### WARNING

Driving through sand and mud can be dangerous. The vehicle can slide uncontrollably. This increases the risk of injury. Always drive carefully through sand, mud and slush.

- Never choose an unsafe route or take a risk which could endanger you or your passengers. If you have any doubts about the safety of the route, turn round and choose a different route.

### WARNING

Incorrect tyre pressure can cause severe or even fatal accidents.

- Incorrect tyre pressures will increase the levels of wear on the tyres and will negatively affect the vehicle's driving response.
- An incorrect tyre pressure can cause overheating, sudden tyre damage including tyre bursts and detachment of the tread and thus to a loss of control over the vehicle.
- If you have nevertheless reduced the tyre pressure for driving through sand, the correct tyre pressure must always be restored before driving on. Driving with reduced tyre pressure can lead to a loss of control over the vehicle and increase the risk of serious and fatal injuries.

## If your vehicle gets stuck

📖 Please refer to  and  on page 160.

The vehicle is stuck if the wheels have sunk so deep into the ground that the vehicle can no longer drive forward or back under its own power.

Rocking a vehicle out of sand or mud requires a great deal of training and feeling for the vehicle. If you make a mistake when rocking the vehicle, it can sink deeper and you will need assistance to get the vehicle out.

Never allow the wheels to spin for long periods as this will cause the vehicle to sink deeper → page 165.

### Preparations

1. Carefully dig out all the wheels and check that no other parts of the vehicle are stuck in the sand or mud.
2. Select reverse gear.
3. Accelerate gently and reverse over your own tracks.

If this does not help, place brushwood, floor mats or sacking directly behind the wheels to increase grip and achieve improved traction → page 165.

### Rocking the vehicle free

1. Switch off TCS → page 207.
2. Position the steering wheel so that it is facing straight ahead.
3. Reverse until the point where the wheels just start to spin.
4. Immediately select first gear and drive forwards until the wheels start to spin again.
5. Repeat driving to and fro until you have enough momentum to free yourself.
6. Switch the TCS on again after rocking the vehicle free.

### WARNING

No-one must stand either in front or behind the vehicle, particularly if you are attempting to free a stuck vehicle.

- Spinning wheels can propel stones, brushwood, pieces of wood or other objects that are in front or behind the wheels at high speed and cause potentially fatal injuries.
- People standing in front of or behind the vehicle could be run over if the stuck vehicle starts to move suddenly.

## Driving in steep terrain

📖 Please refer to  and  on page 160.

### Driving up and down hills

Get out of the vehicle and assess the situation before you attempt to drive up or down a hill:

- Walk along the section and check the firmness of the ground. Look out for obstacles and other hidden dangers → .
- Check the section beyond the hill.
- You should not follow the route if it is too steep, uneven or if the ground surface is too loose. Select another route.
- Drive slowly and at constant speed straight up or down a slope.
- Never attempt to stop or turn on a slope.
- Accelerate only to the speed you need to climb the slope. Too much acceleration can cause the wheels to spin and lead to a loss of control of the vehicle. Too little acceleration increases the probability of stalling the engine.
- *Vehicles with a manual gearbox* Do not change gear or engage the clutch when climbing a slope.
- *Vehicles with an automatic gearbox* Do not change gear during the climbing phase.
- Use the offroad display → page 159.

### If you cannot continue to drive up a hill

- Never turn the vehicle around on an uphill gradient.
- If the engine has stalled, depress the foot brake and start the engine again.
- Engage reverse gear and slowly move back on a straight path.
- Use the foot brake to keep a constant speed until you have reached safe and flat ground.

### Driving downhill

There is an increased risk of rolling over when driving downhill. Concentrate on steering the vehicle, especially when driving downhill.

- Drive down steep inclines in first gear.
- Use the foot brake sparingly in order not to lose control of the vehicle.
- Never exceed the inclination angle of the vehicle.
- If it is possible and not dangerous, drive straight down the slope on the maximum gradient (in the fall line).
- Use the offroad display and Hill Descent Control on steep downhill stretches → page 159.

## ⚠ WARNING

Never attempt to drive up or down an incline if it is too steep for the vehicle. The vehicle could slide away, tip over or roll.

- The gradient or inclination angle must be no greater than the maximum permissible value for the vehicle.
- Always drive up and down hills in the fall line.
- Never turn or turn round when driving up or down a gradient. The vehicle could tip over or slide away sideways.
- If the engine stops or you cannot drive on, stop the vehicle and press the brake pedal. Start the engine again. Engage reverse gear, release the brake pedal and use the engine braking effect to reverse back carefully, keeping the vehicle straight in the fall line. Maintain a slow and constant speed.
- If you are unable to start the engine, apply constant force to the brake pedal and allow the vehicle to roll back down the hill in its own track. Maintain a slow and constant speed.
- Never let the vehicle roll backwards down a slope in neutral. You could lose control over the vehicle.

## Traversing a slope

📖 Please refer to ⚠ and ⌚ on page 160.



Fig. 134 Illustration: steering into the fall line.



Fig. 135 Illustration: use the doors facing up hill to get out of the vehicle.

Traversing a slope is one of the most dangerous off-road situations → ⚠.

Check whether you can use another safer route before driving across a slope.

If you have to traverse a slope:

- The vehicle's centre of gravity should be as low as possible. People with a larger or heavier build should sit on the higher side of the vehicle. Remove the roof carrier and secure heavy items. The vehicle could tip over if items were to slide suddenly → ⚠.
- If possible, the ground must be firm. The vehicle is more likely to slip sideways and tip over on slippery or soft ground. Always make sure that the inclination angle does not become too great due to uneven ground. If the inclination angle is too great, the vehicle could tip and roll over.
- When driving across a slope at a large tilt angle, the wheels on the lower side of the vehicle must never enter dips or hollows. The wheels on the higher side of the vehicle must never drive over bumps, for example stones, tree trunks or other obstacles.
- If the vehicle threatens to tip over, steer immediately into the fall line and depress the accelerator slightly → Fig. 134. If it is not possible to steer into the fall line, then steer uphill and depress the accelerator slightly.

## ⚠ WARNING

Never try to drive at an angle on the slope, particularly if it is too steep for the vehicle. A vehicle that is in a sideways position to the slope can slip away in an uncontrolled manner, tip or roll over. Please note the following points in order to reduce the risk of accidents and serious injuries:

- You should never underestimate the difficulty and danger of traversing a slope. Never choose an unsafe route or take a risk which could endanger you or your passengers. If you have any



doubts about the safety of the route, turn round and choose a different route.

- The vehicle can lose its grip and slide away sideways, tip over or roll over and roll down the hill.
- Never allow the wheels on the lower side of the vehicle to enter dips or hollows. Never drive over bumps, for example stones, tree trunks or other obstacles, with the wheels on the higher side of the vehicle.
- Make sure that you can steer into the fall line before driving across a slope. Choose a different route if this is not possible. If the vehicle threatens to tip over, steer immediately into the fall line and depress the accelerator slightly → Fig. 134.
- If the vehicle is stopped with a large side inclination angle when traversing a slope, avoid sudden and uncontrolled movements in the vehicle. The vehicle can lose its grip and slide away sideways, tip over or roll over and roll down the hill.
- Vehicle occupants should never leave the vehicle via the doors facing down the hill if the vehicle is stopped on a slope with a large side inclination angle. This could cause the centre of gravity to move sideways. The vehicle could tip or roll over and roll down the hill. To avoid this, always leave the vehicle carefully on the side that is facing uphill → Fig. 134.
- When getting out the vehicle, make sure that the vehicle door which opens uphill does not close with its own weight or through carelessness thus potentially causing injury.

## Driving through ditches

📖 Please refer to ⚠️ and 🕒 on page 160.

1. Check whether the ramp and inclination angles are small enough to drive through the ditch with the vehicle. The inclination angle must not get too large when driving through the ditch → ⚠️.
2. Find a suitable place to cross the ditch.
3. If possible, cross the ditch at an acute angle → ⚠️.

### ⚠️ WARNING

Never drive through a ditch if the slope and tilt angle are too steep for the vehicle and the ditch is too deep. The vehicle could slide away, tip or roll over.

### 🕒 NOTICE

If you drive into the ditch at a right angle, the front wheels will fall in. The underbody of your vehicle can bottom on the ground, become stuck and be damaged. It is then almost impossible to get out of the ditch despite having all-wheel drive.

## After offroad driving

📖 Please refer to ⚠️ and 🕒 on page 160.

### Checklist

- ✓ Clean the vehicle.
- ✓ Check the vehicle for damage.
- ✓ Check the tyres for damage and remove dirt, stones and other foreign bodies from the tyre tread.
- ✓ Inspect the vehicle underbody and remove all items that are jammed in the brake system, in the wheels, in the running gear, in the exhaust system and in the engine, such as branches, leaves or pieces of wood → ⚠️. If you find damage or leaks, go to a correspondingly qualified workshop. Volkswagen recommends using a Volkswagen dealership.
- ✓ Check the engine compartment to see if any dirt is affecting engine operation → page 310.

### ⚠️ WARNING

Objects caught underneath the vehicle underbody are a danger. The vehicle underbody must always be examined for trapped objects after every journey offroad.

- Never drive if objects are trapped in the underbody, brake system, wheels, running gear, exhaust system and engine.
- Inflammable materials such as dry leaves could ignite on hot vehicle components. A fire can cause serious injuries.
- Trapped objects could damage the fuel lines, brake system, seals and other components. This could cause you to lose control of your vehicle and cause accidents.

# Driver assist systems

## Cruise control system

### Introduction to the topic

The cruise control system helps to maintain a speed set by the driver.

#### Speed range

The CCS is available when driving forwards at speeds from around 20 km/h (15 mph).

#### Driving with the cruise control system

You can exceed the stored speed at any time, e.g. to overtake. Control is interrupted for the duration of the acceleration manoeuvre and is then resumed with the stored speed.

#### Displays

When the CCS is switched on, the instrument cluster display shows the stored speed and the status of the CCS.

Depending on the situation and the instrument cluster version, one of following indicator lamps lights up:



CCS switched on.



CCS switched on, system control active.



CCS switched on, system control active.

The indicator lamps are displayed small or grey when the CCS is not active.

If no speed is stored, the instrument cluster display shows --- instead of the speed.

#### Changing gear

Cruise control is interrupted as soon as you depress the clutch pedal and is resumed automatically after the gear change.

#### Driving downhill

The vehicle cannot maintain the stored speed in all driving situations. Always be prepared to brake the vehicle.

1. Shift down before extended downhill stretches.

In this way you will make use of the engine braking effect and relieve the load on the brakes.

### WARNING

The use of the CCS can lead to accidents and serious injuries if traffic does not allow you to drive at a safe distance from the vehicle in front at a constant speed.

- Never use the CCS in heavy traffic, if the distance to the vehicles in front is insufficient, on steep or winding roads, on slippery road surfaces, e.g. due to snow, ice, wet roads, loose chip-pings, or on flooded roads.
- Never use the CCS when driving offroad or on unpaved road surfaces.
- Adapt your speed and distance from the vehicles ahead to suit visibility, weather, road and traffic conditions.
- Always switch CCS off after use to avoid unintentional speed control.
- It is dangerous to use a set speed that is too high for the prevailing road, traffic or weather conditions.

### Operating the Cruise Control System (CCS)

Please refer to  at the start of the chapter on page 168.



Fig. 136 Lefthand side of the multifunction steering wheel (Variant 1)



**Fig. 137** Lefthand side of the multifunction steering wheel (Variant 2)

### Switching on





1. Press the  button.  
No speed is stored. The system is not yet active.



### Starting control

1. While driving, press the  button.  
The CCS stores and regulates the current speed.

### Adjusting the speed



You can adjust the stored speed during speed control by the CCS:

- + 1 km/h (1 mph): Press the  button.
- 1 km/h (1 mph): Press the  button.
- + 10 km/h (5 mph): Press the  button.  
*Steering wheel variant 2:* alternatively, swipe over the button from bottom to top.  
The first time it is pressed, it jumps to the next higher ten (km/h) or five (mph) increment.
- 10 km/h (5 mph): Press the  button.  
*Steering wheel variant 2:* alternatively, swipe over the button from top to bottom.  
The first time it is pressed, it jumps to the next lower ten (km/h) or five (mph) increment

Press and hold the  or  button to continuously change the stored speed.

The vehicle adapts the current speed by accelerating or closing the throttle. The vehicle does not actively brake.

### labelling control

1. Briefly press the  or  button.  
**Or:** depress the brake pedal.  
The speed remains stored in the memory.

### Resuming control



1. Press the  button.  
The CCS resumes operation with the stored speed and regulates the speed again.

### Switching off



1. Press and hold the  button.  
The CCS is switched off and the stored speed is deleted.

### Changing to the speed limiter

1. Press the  button.
2. Select the speed limiter on the instrument cluster display.  
The CCS is switched off.

 Depending on equipment, the  button is either on the multifunction steering wheel or on the turn signal lever. <

## Troubleshooting

 Please refer to  at the start of the chapter on page 168.

### Fault in the cruise control system

Malfunction. The indicator lamp lights up yellow.

1. Switch off CCS and go to a correspondingly qualified workshop. Volkswagen recommends using a Volkswagen dealership.

### Fault in the cruise control system

Malfunction. The indicator lamp lights up white. The yellow central warning lamp  also lights up.

1. Switch off CCS and go to a correspondingly qualified workshop. Volkswagen recommends using a Volkswagen dealership.

### Control is interrupted automatically

- You have kept the clutch depressed for an extended period.
- The vehicle has exceeded the stored speed for an extended period.
- No gear is engaged for forward travel.
- Brake support systems, e.g. TCS or ESC, have performed an intervention.
- The vehicle was braked by Front Assist.

- If the problem persists, switch off CCS and go to a correspondingly qualified workshop. Volkswagen recommends using a Volkswagen dealership. <

## Speed limiter

### Introduction to the topic

The speed limiter helps to prevent the vehicle from exceeding a speed that you have stored.

#### Speed range

The speed limiter is available when driving forwards at speeds from around 30 km/h (around 20 mph).

#### Driving with the speed limiter

You can interrupt the speed limiter function at any time by fully depressing the accelerator beyond the point of resistance. As soon as the stored speed is exceeded, the green indicator lamp will flash and an acoustic warning may sound. The speed remains stored in the memory.

The speed limiter function is activated again automatically as soon as the speed drops below the stored speed.

#### Displays

When the speed limiter is switched on, the instrument cluster display shows the stored speed and the status of the speed limiter.

Depending on the situation and the instrument cluster version, one of following indicator lamps lights up:



The speed limiter is switched on.



Speed limiter switched on, system control active.



Speed limiter switched on, system control active.

The indicator lamps are displayed small or grey when the speed limiter is not active.

#### Driving downhill

The vehicle cannot maintain the stored speed in all driving situations. Always be prepared to brake the vehicle.

1. Shift down before extended downhill stretches.

In this way you will make use of the engine braking effect and relieve the load on the brakes.

### WARNING

Always switch off the speed limiter after use to avoid unintentional intervention.

- The speed limiter does not relieve the driver of their responsibility for the speed of the vehicle. Do not drive at full throttle if this is not necessary.
- Use of the speed limiter in adverse weather conditions is dangerous and can cause serious injury, e.g. through aquaplaning, snow, ice, or leaves. Use the speed limiter only when the road and weather conditions allow it to be used safely. <

### Operating the speed limiter

Please refer to ⚠ at the start of the chapter on page 170.



Fig. 138 Lefthand side of the multifunction steering wheel (Variant 1)



**Fig. 139** Lefthand side of the multifunction steering wheel (Variant 2)

### Switching on

1. Press the button.  
No speed is stored. The system is not yet active.

### Starting control

1. While driving, press the button.  
The current speed is stored as the maximum speed.

### Adjusting the speed

You can adjust the stored speed:

- + 1 km/h (1 mph): Press the button.
- 1 km/h (1 mph): Press the button.
- + 10 km/h (5 mph): Press the button.  
*Steering wheel variant 2:* alternatively, swipe over the button from bottom to top.  
The first time it is pressed, it jumps to the next higher ten (km/h) or five (mph) increment.
- 10 km/h (5 mph): Press the button.  
*Steering wheel variant 2:* alternatively, swipe over the button from top to bottom.  
The first time it is pressed, it jumps to the next lower ten (km/h) or five (mph) increment

Press and hold the or button to continuously change the stored speed.

### Cancelling control

1. Press the button or .
- The speed remains stored in the memory.

### Resuming control

1. Press the button.

### Switching off

1. Press and hold the button.

The speed limiter is switched off and the saved speed is deleted.

### Switch to other driver assist systems

Depending on the equipment, you can switch to the following driver assist systems:

- Cruise control system (CCS).
- Adaptive Cruise Control (ACC).

1. Press the button.
2. Select the desired system on the instrument cluster display.

The speed limiter is switched off.

- Depending on equipment, the button is either on the multifunction steering wheel or on the turn signal lever. <

## Troubleshooting

Please refer to at the start of the chapter on page 170.

### Control is interrupted automatically

Fault or malfunction.

1. Switch off and restart the engine.
2. If the problem persists, switch off the speed limiter and go to a correspondingly qualified workshop. Volkswagen recommends using a Volkswagen dealership.

For safety reasons, the speed limiter switches itself off completely only when you release the accelerator once or switch off the system manually.

### Control cannot be started

The selected driving profile does not allow control to be started.

1. Select a different driving profile and repeat the process. <

## Adaptive Cruise Control (ACC)

### Introduction to the topic

The Adaptive Cruise Control (ACC) maintains a constant speed that you have set. If the vehicle approaches a vehicle in front, the ACC automatically adapts the speed so that a distance you have selected is maintained.

### Does the vehicle have ACC?

The vehicle is equipped with ACC if you can adjust settings for ACC in the Assist systems menu in the Infotainment system.

### Speed range

You can set a speed between around 30 km/h (20 mph) and around 210 km/h (130 mph). Depending on equipment and country, the maximum speed that can be set may be lower.

### Driving with ACC

You can override the active ACC system at any time. Cruise control will be stopped if you brake. If you accelerate, cruise control will be interrupted while you are accelerating and then resumed.

The intervention by the ACC system is less dynamic when towing a trailer.

### Driver intervention prompt



If automatic deceleration by the ACC system is not sufficient or the system limits have been reached, the ACC system will request you to also brake by a corresponding message on the instrument cluster. In addition, the red warning lamp lights up and an acoustic warning is given. Take over control of the vehicle and be prepared to brake.

### Radar sensor

ACC detects driving situations using a radar sensor at the front of the vehicle. The range of the radar sensor is up to approximately 120 m (around 400 ft).

### WARNING



The intelligent ACC technology cannot overcome the laws of physics, and functions only within the limits of the system. Never let the extra convenience tempt you into taking safety risks when driving. Careless or unintentional use of the ACC can cause accidents and lead to serious injury. The system is not a substitute for the full concentration of the driver.

- Adapt your speed and the distance from the vehicles ahead to suit visibility, weather, road and traffic conditions.
- Never use the ACC in poor visibility, on steep or winding roads, or on slippery road surfaces, e.g. due to snow, ice, wet roads, loose chippings, or on flooded roads.
- Never use the ACC offroad or on non-surfaced roads. The ACC is designed for use on surfaced roads only.
- Take control of the vehicle immediately if requested to do so by a prompt on the instrument

cluster display or if the speed reduction by ACC is not sufficient.

- Brake if the vehicle starts moving unintentionally, e.g. after a driver intervention prompt.
- Be prepared to control the speed yourself at all times.

## Special driving situations

 Please refer to  at the start of the chapter on page 171.

### Predictive cruise control system

If the vehicle is equipped with the Dynamic Road Sign Display function and an Infotainment system with navigation, ACC can predictively adapt the vehicle speed to detected speed limits and the course of the road ahead (depending on equipment and not available in all countries).

### Overtaking

If you indicate left (left-hand traffic: indicate right) to overtake, ACC will accelerate the vehicle and reduce the distance from the vehicle in front. Your set speed will not be exceeded.

If ACC does not detect any vehicle in front after you have changed lane, ACC will accelerate the vehicle up to the set speed.

Overtaking assistance is not available in all countries.

### Stop-and-go traffic

ACC can brake vehicles with an automatic gearbox to a standstill and hold them stationary. ACC remains active and the instrument cluster display shows ACC ready to start for a few seconds.

*Vehicles with Travel Assist:* You can extend this time by continuing to hold the steering wheel.

As long as ACC remains active, the vehicle will move off again automatically as soon as the vehicle in front moves off (depending on the vehicle equipment level and not available in all countries).

Extending or reactivating readiness to drive:

1. Press the **(RES)** button.

**Or:** *Vehicles with Travel Assist:* take hold of the steering wheel again.

Moving off when readiness to drive has ended and the vehicle in front has already moved away:

1. Press the **(RES)** button.

**Or:** depress the accelerator briefly.

ACC remains inactive in the following cases:

- The vehicle is stationary for several minutes.
- A vehicle door is opened.
- The ignition is switched off.

### **⚠ WARNING**

If the message ACC ready to start is shown on the instrument cluster display and the vehicle in front moves off, your vehicle will move off automatically. In some cases, obstacles in the vehicle's path may not be detected. This can result in serious injury and accidents.

- Always check the road ahead before moving off and brake the vehicle if necessary.

### Inside Overtaking Prevention System

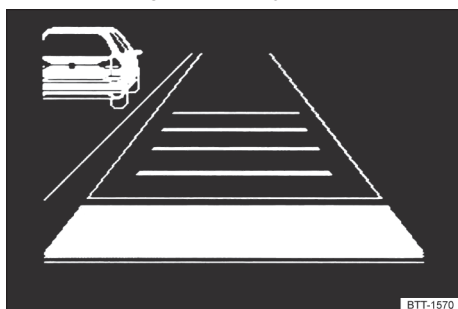

**Fig. 140** On the instrument cluster display: slower vehicle detected in the left-hand lane (illustration).

If ACC detects a slower vehicle in the left-hand lane (left-hand traffic: in the right-hand lane), ACC will brake the vehicle gently within the system limits and can therefore prevent a prohibited overtaking manoeuvre. The function is active from speeds of around 80 km/h (around 50 mph), but is not available in all countries.

### Limits of the ACC

📖 Please refer to **⚠** at the start of the chapter on page 171.

#### When not to use the ACC

ACC is not suitable for use in the following driving situations due to the system limitations. To cancel control → **⚠**:

- Driving in heavy rain, snow or heavy spray.
- Driving through road works, tunnels or toll stations.
- Driving on winding roads, e.g. mountain roads.

- Driving offroad.
- Driving in multi-storey car parks.
- Driving on roads with embedded metal objects, e.g. railway tracks.
- Driving on roads with loose chippings.
- *Vehicles without Inside Overtaking Prevention System*: On roads with more than one lane, if other vehicles are driving more slowly in the overtaking lane.
- After external force on components in the area of the radar sensor, e.g. after a rear-end collision.

### **⚠ WARNING**

If you use ACC in the above situations, this could result in accidents and serious injuries as well as violations of legal regulations.

#### Delayed response

If the radar sensor is exposed to environmental conditions that impair sensor functioning, the system may detect this only after a certain delay. For this reason, any restrictions to functions may be displayed only after a delay at the start of the journey and when driving → page 171.

#### Objects that cannot be detected

ACC detects only vehicles that are moving in the same direction or stationary. The following are not detected:

- Persons.
- Animals.
- Crossing or oncoming vehicles.
- Other stationary obstacles.

#### Stationary vehicles

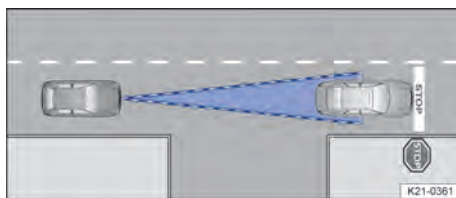
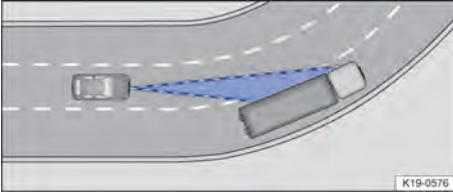

**Fig. 141** Stationary vehicle.

ACC reacts to stationary vehicles to a limited extent up to a speed of 60 km/h (37 mph), provided a stationary vehicle is detected and your own vehicle can be comfortably braked behind the stationary vehicle, subject to the system limits of the ACC. ACC does not perform emergency braking → Fig. 141.

The response to stationary vehicles depends on the vehicle equipment and is not available in all countries.

#### Bends



**Fig. 142** Driving through bends.

The radar sensor always measures straight ahead. For this reason, vehicles may be incorrectly detected or vehicles driving ahead not detected in tight bends → Fig. 142.

#### Vehicles outside the sensor range



**Fig. 143** Narrow vehicle.

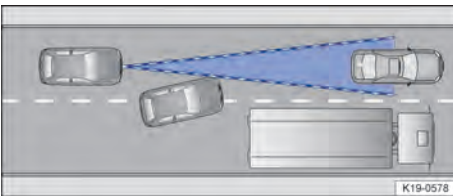

**Fig. 144** Vehicle changes lane.

ACC may not react or may react with a delay or with an unwanted response in the following driving situations:

- Vehicles that are driving outside the sensor range in close proximity to your vehicle, e.g. motorbikes → Fig. 143.
- Vehicles that change into your lane directly in front of your vehicle → Fig. 144.
- Vehicles with bodies or attachments that project beyond the vehicle. ◀

## Switching the ACC on and off

◻ Please refer to ⚠ at the start of the chapter on page 171.



**Fig. 145** Lefthand side of the multifunction steering wheel (Variant 1)



**Fig. 146** Lefthand side of the multifunction steering wheel (Variant 2)

#### Switching on

1. Press the button.

ACC is not yet performing a control intervention.

#### Starting control

1. While driving forwards, press the button.

ACC stores the current speed and maintains the set distance. If the current speed is outside the defined speed range, ACC will set the minimum speed when driving more slowly than the limit or maximum speed when driving faster than the limit.

In addition, the traction control system (TCS) is activated and ESC Sport is deactivated.



Depending on the situation and the instrument cluster version, the following warning lamps light up:



ACC has taken control.



ACC has taken control; no vehicle detected ahead.



ACC has taken control; no vehicle detected ahead.



ACC has taken control; vehicle detected ahead.



ACC has taken control; vehicle detected ahead.

When ACC is not active, the indicator lamps are not lit or light up grey.

### lab Cancelling control

1. Briefly press the  button.

**Or:** depress the brake pedal.

The indicator lamp corresponding to the driving situation lights up, and the speed and distance remain stored.

Control is automatically cancelled if the traction control system (TCS) is deactivated.

### lab Resuming control

1. Press the  button.

ACC adopts the last set speed and last set distance. The instrument cluster display shows the set speed and the indicator lamp corresponding to the driving situation lights up.

### lab Switching off

1. Press and hold the  button.

The set speed is deleted.

### lab Changing to the speed limiter



1. Press the  button.
2. Select the speed limiter on the instrument cluster display.

ACC is switched off.



Depending on equipment, the  button is either on the multifunction steering wheel or on the turn signal lever. <

## Setting the ACC



 Please refer to  at the start of the chapter on page 171.



### Setting the distance





**Fig. 147** On the instrument cluster display: set distance  (illustration, the ACC is controlling distance).

You can set the distance in five steps from very small to very large:

1. Press the  button.
2. Press the button  or .

*Steering wheel variant 2:* Alternatively, swipe vertically over the button area from  to  or .

**Or:** press the  button repeatedly until the required distance is selected.

The instrument cluster display shows the chosen setting → Fig. 147 . Please observe any country-specific regulations for the minimum distance.

In the Assist systems menu of the Infotainment system, you can choose whether you want to start control with the distance set at the end of the journey or a preselected distance.

If the ACC has not taken control, the set distance and vehicle are not highlighted on the instrument cluster display.

### lab Adjusting the speed

You can adjust the stored speed within the defined speed range by means of the buttons on the multifunction steering wheel:

**+ 1 km/h (1 mph):** Press the  button, only when ACC is active.

**- 1 km/h (1 mph):** Press the  button, only when ACC is active.

+ 10 km/h (5 mph): Press the  button.



*Steering wheel variant 2:* alternatively, swipe over the button from bottom to top.

The first time it is pressed, it jumps to the next higher ten (km/h) or five (mph) increment.

- 10 km/h (5 mph): Press the  button.

*Steering wheel variant 2:* alternatively, swipe over the button from top to bottom.

The first time it is pressed, it jumps to the next lower ten (km/h) or five (mph) increment

Press and hold the  or  button to continuously change the stored speed.

### WARNING

If you do not maintain the minimum distance to the vehicle in front or if the difference in speed between the vehicle in front and your own vehicle is so great that the braking action of ACC is insufficient, you are in danger of colliding with the vehicle in front. The braking distance is also longer in rain and winter road conditions.

- The Adaptive Cruise Control may not be able to detect all driving situations correctly.
- Always be prepared to brake the vehicle yourself.
- Speed and distance control are overridden when you press the accelerator. The ACC does not brake automatically in this case.
- Observe any country-specific regulations relating to the minimum distance.
- Always set a larger distance in wet or snowy conditions or when visibility is poor.



### Setting the system behaviour

You can influence how sportily ACC reacts:

- *Vehicles with driving profile selection:* Set preferred driving profile → page 155.
- *Vehicles without driving profile selection:* Select the desired gearbox program in the Assist systems menu of the Infotainment system.

 Some settings can be stored in the user accounts of the personalisation function and therefore change automatically when the user account changes → page 41.

## Troubleshooting

 Please refer to  at the start of the chapter on page 171.

### ACC not available

The indicator lamp lights up yellow.

- The radar sensor is dirty. Clean the radar sensor → page 355.
- The view of the radar sensor is impaired due to the weather conditions, e.g. snow, or due to detergent deposits or coatings. Clean the radar sensor → page 355.
- The view of the radar sensor is impaired by add-on parts, the trim frames of number plate holders or stickers. Keep the area around the radar sensor free.
- The radar sensor has been displaced or damaged, e.g. due to damage to the front of the vehicle. Check whether damage is visible → page 362.
- Fault or malfunction. Switch off and restart the engine.
- Paint work or structural modifications were carried out on the front of the vehicle.
- The genuine Volkswagen badge is not used. Volkswagen recommends using Volkswagen Genuine Parts or Volkswagen Genuine Accessories, which you can purchase from a Volkswagen dealership.
- If the problem persists, go to a correspondingly qualified workshop. Volkswagen recommends using a Volkswagen dealership.

### The ACC does not function as expected

- The radar sensor is dirty. Clean the radar sensor → page 355.
- The system limits have been exceeded → page 173.
- The brakes have overheated, control was cancelled automatically. Allow the brakes to cool down and check their functionality again.
- If the problem persists, go to a correspondingly qualified workshop. Volkswagen recommends using a Volkswagen dealership.

### Control cannot be started

Make sure that the following conditions are met:

- *Vehicles with a manual gearbox:* A forward gear other than 1st gear has been engaged and the speed is at least 25 km/h (16 mph).
- *Vehicles with an automatic gearbox:* A position has been selected for driving forward.

- The brake lights on the vehicle are working.
- The brake lights on the electrically connected trailer are in working order.
- ESC is not performing a control intervention.
- The brake pedal is not depressed.

#### Unusual noises during automatic braking

This is normal and is not a fault.

## Predictive cruise control system

### Introduction to the topic

The predictive cruise control adapts the vehicle speed to detected speed limits and the course of the road ahead, e.g. bends, junctions, roundabouts.

The predictive cruise control is an extension of ACC and makes use of Dynamic Road Sign Display and the navigation data provided in the Infotainment system.

The predictive cruise control function is dependent on the equipment level and is not available in all countries.

### WARNING

The intelligent technology of predictive cruise control cannot overcome the physical limits specified, and functions only within the limits of the system. Never let the extra convenience afforded by predictive cruise control tempt you into taking any safety risks. Careless or unintentional use of predictive cruise control can cause accidents and lead to serious injury. The system is not a substitute for the full concentration of the driver.

- Ensure that your speed is always appropriate for the current visibility, weather and road/traffic conditions.
- Always pay attention to the traffic situation and the area around the vehicle.
- Be prepared to control the speed yourself at all times. Malfunctions in the Dynamic Road Sign Display function and out-of-date navigation data can lead to the speed being changed unexpectedly and suddenly or not being adapted to the current traffic situation. Speeds regulated by the system may also not match your individual driving style.



- Be prepared to control the speed yourself at all times. If you are driving without route guidance or leave the route calculated by the navigation system or if the vehicle position cannot be correctly determined due to inexact GPS data, the speed may be changed unexpectedly and suddenly or not adapted to the current traffic situation.

- Keep the navigation data up-to-date.
- Always observe the maximum speed limit. The maximum speed limit may be exceeded in the case of speed limits that are not contained in the navigation data.



Please also observe the safety-relevant information on ACC.

### Limits of predictive cruise control

 Please refer to  at the start of the chapter on page 177.

In addition to the system limitations of the Dynamic Road Sign Display function and ACC, the predictive cruise control function has the following additional, system-related limitations:

- The predictive cruise control function detects only road signs that show a speed limit. In particular, predictive cruise control does not take into account any rights of way or traffic lights.
- Road signs that indicate a speed limit indirectly, e.g. place-name signs, will be detected only on the basis of the navigation data.
- Predictive cruise control is not available on roads which are not recorded in the navigation data or not recorded with sufficient accuracy.
- If a speed limit is announced on the basis of the navigation data but is not detected by the Dynamic Road Sign Display function, the announced speed will be reset to the last-stored speed.
- The predictive cruise control system cannot perform control at speeds below the minimum speed → page 171.

## Activating predictive cruise control

📖 Please refer to  at the start of the chapter on page 177.

You can separately set the events to which the vehicle should react in the Assist systems menu of the Infotainment system:

- Reaction to the road layout.
- Reaction to permitted speeds.

If you have activated at least one event, predictive cruise control will also be switched on automatically when ACC is switched on.

## Driving with predictive cruise control

📖 Please refer to  at the start of the chapter on page 177.

### Displays

A message will be displayed on the instrument cluster display as soon as the system detects a speed limit or will reduce the speed due to the course of the road ahead. This message indicates the reason and the speed to which your vehicle will be regulated.



Speed regulation due to speed limit.



Speed regulation due to the road layout.

When automatic speed control is assumed due to a speed limit, the detected speed is stored as the new desired speed. In the case of control due to the road layout, the vehicle will subsequently accelerate back up to the previously stored speed.

Announced speeds for driving through bends depend on the driving profile → page 155.

### Cancelling speed adaptation

During the announcement:

1. Press the  button.

During control intervention:

1. Press the  button.

### Adjusting the announced speed

The announced speed can be adjusted only in the case of speed regulation due to a speed limit.

- + 1 km/h (1 mph): Press the  button only when ACC is active.

- 1 km/h (1 mph): Press the  button only when ACC is active.

- + 10 km/h (5 mph): Press the  button.

*Steering wheel variant 2:* alternatively, swipe over the button from bottom to top.

The first time it is pressed, it jumps to the next higher ten (km/h) or five (mph) increment.

- 10 km/h (5 mph): Press the  button.

*Steering wheel variant 2:* alternatively, swipe over the button from top to bottom.

The first time it is pressed, it jumps to the next lower ten (km/h) or five (mph) increment.

◀ If you adjust the announced speed excessively, predictive cruise control will be terminated.



If a speed limit is detected, the predictive cruise control function will adjust the stored speed even if ACC is deactivated. However, speed regulation will not take place.



When a speed limit is lifted on a motorway, the recommended speed will automatically be stored as the desired speed. However, if a higher speed has previously been stored on a motorway without a speed limit, this will be adopted instead of the recommended speed. ▶

## Troubleshooting

📖 Please refer to  at the start of the chapter on page 177.

**A message is displayed that predictive cruise control is currently not available or is not available in your country**

1. If this message is displayed for an extended period and predictive cruise control is available in your country, go to a correspondingly qualified workshop. Volkswagen recommends using a Volkswagen dealership.



Depending on the malfunction, additional information may be displayed in the vehicle status → page 37. ▶

# Area monitoring system (Front Assist)

## Introduction to the topic

The Autonomous Emergency Braking (Front Assist) can detect imminent frontal collisions and issue corresponding warnings. The system can also assist when braking and initiate automatic braking.

Front Assist can help to avoid accidents, but is not a substitute for the full concentration of the driver.

Front Assist functions only within the system limits. The warning times vary depending on the traffic situation and driver behaviour.

### Functions

Front Assist includes the following additional functions depending on vehicle equipment and country:

- Pedestrian Monitoring.

The listed functions are automatically active (if present) when Front Assist is switched on.

### Detectable objects

Front Assist can detect the following objects depending on vehicle equipment and country:

- Vehicles.
- Bicycles and motorcycles.
- Pedestrians.

### Driving with Front Assist

You can cancel the automatic braking interventions by steering or pressing the accelerator.

### Automatic braking

Front Assist can decelerate the vehicle to a standstill. The vehicle will then not be held permanently. Depress the brake pedal!

The brake pedal will feel harder during an automatic braking operation.

### Detection of the driving situation

Front Assist detects driving situations by means of the radar sensor at the front of the vehicle. The range of the radar sensor is up to approximately 120 m (400 ft).

## WARNING

The intelligent technology used in Front Assist cannot overcome the physical limits specified, and

functions only within the limits of the system. Never let the extra convenience afforded by Front Assist tempt you into taking risks when driving. Front Assist cannot prevent accidents and serious injuries on its own. The driver is always responsible for all driving tasks.

- Adapt your speed and distance from the vehicles ahead to suit visibility, weather, road and traffic conditions.
- Please note that Front Assist cannot detect all objects throughout the entire speed range → page 180.
- If Front Assist issues a warning, brake your vehicle immediately depending on the traffic situation or avoid the obstacle.
- Front Assist can intervene unintentionally, for example if its functioning is impaired. You should therefore consider cancelling the automatic interventions by Front Assist if appropriate.
- If you are unsure about what systems your vehicle has, please enquire at a correspondingly qualified workshop before starting your journey. Volkswagen recommends using a Volkswagen dealership.

## Warning levels and braking intervention

Please refer to  at the start of the chapter on page 179.

### Speed ranges

Front Assist provides maximum assistance in the following speed ranges:

- Reaction to vehicles: around 5 km/h (around 3 mph) to around 250 km/h (around 155 mph).
- Reaction to bicycles and motorcycles: around 5 km/h (around 3 mph) to around 250 km/h (around 155 mph).
- Reaction to pedestrians: around 5 km/h (around 3 mph) to around 65 km/h (around 40 mph).

The assistance may include an advance warning, an urgent warning and automatic braking or a braking intervention. A distance warning may also be displayed.

### Influencing factors

Whether and in what speed range Front Assist reacts to the specified objects depends on the following factors:

- Type of object.

- Direction of travel of the object.
- Speed of the object.
- Speed of the vehicle.

The operating range may therefore be restricted if the vehicle approaches an object very quickly and there is therefore little time for a reaction.

In addition, not all warning levels are used in all situations. Depending on speed, there may not be an advance warning or an urgent warning, for example. Instead, automatic braking may take place immediately in order to ensure optimum protection for the object.

#### Distance warning



Front Assist detects when safety is endangered by driving too close to the vehicle in front.

The indicator lamp lights up. Increase the distance.

#### Advance warning



Front Assist detects a possible collision and prepares the vehicle for possible emergency braking.

An acoustic warning sounds and the red warning lamp lights up. Brake or take avoiding action.

#### Urgent warning

If you do not react to the advance warning, the system may initiate a short braking jolt in order to draw attention to the increasing collision risk. Brake or take avoiding action.

#### Automatic braking

Front Assist can brake the vehicle automatically in several stages with increasing braking force. The reduced speed means that it is possible to minimise the consequences of an accident.

#### Braking intervention

If the system detects that you are braking insufficiently when there is a risk of collision, Front Assist can increase the braking force and help prevent a collision. The braking intervention takes place only for as long as you press the brake pedal hard. <

## Limits of Front Assist

📖 Please refer to 🚩 at the start of the chapter on page 179.



Immediately after vehicle start or after a system restart, Front Assist

is not available or only partially available. The indicator lamp lights up in the instrument cluster display during this time.

Front Assist has physical and system-related limitations. You should therefore always be prepared to take full control of the vehicle if necessary.

#### Delayed response

If the radar sensor is exposed to environmental conditions that impair sensor functioning, the system may detect this only after a certain delay. For this reason, any restrictions to functions may be displayed only after a delay at the start of the journey and when driving → page 179.

#### Objects that cannot be detected

Front Assist cannot react – or will react with a delay – in the case of the following objects:

- Vehicles that are driving outside the sensor range in close proximity to your vehicle, e.g. vehicles that are driving offset to your vehicle or motorbikes.
- Vehicles that change into your lane directly in front of your vehicle.
- Vehicles with bodies or attachments that project beyond the vehicle.
- Oncoming vehicles or vehicles crossing your path.
- Stationary or oncoming pedestrians; generally no reaction to persons without Pedestrian Monitoring.
- Stationary, oncoming or crossing cyclists.
- When pedestrians and cyclists are not detected, for example because they are partially or fully hidden.

#### Function limitations

Front Assist may not react or may react with a delay or provide with an unwanted response in the following situations:

- In tight bends.
- Driving in heavy rain, snow or heavy spray.
- Driving in multi-storey car parks and tunnels.
- Driving on roads with embedded metal objects, e.g. railway tracks.
- Reversing.
- If ESC is performing a control intervention.
- If the **Offroad** driving profile mode is switched on (depending on equipment).
- If ESC Sport (depending on equipment) is switched on → page 209.
- If the radar sensor is dirty or covered.
- If several brake lights on the vehicle are faulty.

- If there is a fault in several brake lights on a trailer with an electrical connection to the vehicle.
- If the vehicle accelerates hard or the accelerator is fully depressed.
- In complex driving situations, e.g. at traffic islands.
- In unclear traffic situations, e.g. vehicles ahead are braking heavily or turning off.
- If there is a fault in Front Assist.

### Switching off Front Assist



Front Assist is not suitable for use in the following situations due to the limitations of the system and must be switched off → :

- If the vehicle is utilised in a capacity beyond usage on public roads, e.g. off-road or on a race track.
- If the vehicle is being towed or is loaded onto another vehicle.
- If the radar sensor is covered by any auxiliary equipment, e.g. auxiliary headlights.
- If the radar sensor is faulty.
- After external force on components in the area of the radar sensor, e.g. after a rear-end collision.
- In the event of multiple unwanted interventions.

### WARNING

Failure to switch off Front Assist in the situations mentioned can result in accidents and serious injuries.

## Operating Front Assist

 Please refer to  at the start of the chapter on page 179.

Front Assist and the advance warning (in some countries) are automatically switched on when you switch on the ignition.



However, Front Assist is not available or only partially available as long as the indicator lamp is on.

Volkswagen recommends that Front Assist and also the distance and advance warnings are switched on at all times. Exceptions → page 180.

### Switching on and off

You can switch Front Assist on and off manually and view the activation status.

On the display of the instrument cluster:

1. Press the  button.

2. Switching Front Assist on or off.



Depending on equipment, the  button is either on the multifunction steering wheel or on the turn signal lever.

In the Infotainment system:

1. Open the Assist systems menu.
2. Switch Front Assist on or off in the corresponding submenu.



If you switch off Front Assist, the advance warning and distance warning will also be switched off. The yellow indicator lamp lights up in the instrument cluster display.

### Setting the distance and advance warnings



If Front Assist is switched on, you can make the following settings in the Assist systems menu of the Infotainment system, depending on the vehicle equipment and country:

- Switch the distance warning on and off.
- Switch the advance warning on and off.
- Set the warning time for the advance warning.



Some settings can be stored in the user accounts of the personalisation function and therefore change automatically when the user account changes → page 41.

## Troubleshooting

 Please refer to  at the start of the chapter on page 179.



or  Front Assist is starting up

The indicator lamp lights up yellow or white depending on the country.

- Front Assist is temporarily unavailable or limited. Front Assist is available after driving straight ahead for a short time, and the indicator light goes out. When the vehicle is not in motion, the indicator lamp lights up continuously.

### Front Assist is not available, the radar sensor does not have sufficient visibility

- The radar sensor is dirty. Clean the radar sensor → page 355.
- The view of the radar sensor is impaired due to the weather conditions, e.g. snow, or due to detergent deposits or coatings. Clean the radar sensor → page 355.
- The view of the radar sensor is impaired by add-on parts, the trim frames of number plate holders

or stickers. Keep the area around the radar sensor free.

- The radar sensor has been displaced or damaged, e.g. due to damage to the front of the vehicle. Check whether damage is visible → page 362.
- Paint work or structural modifications were carried out on the front of the vehicle.
- The genuine Volkswagen badge is not used. Volkswagen recommends using Volkswagen Genuine Parts or Volkswagen Genuine Accessories, which you can purchase from a Volkswagen dealership.
- If the problem persists, switch off Front Assist and go to a correspondingly qualified workshop. Volkswagen recommends using a Volkswagen dealership.

#### **Front Assist does not function as expected or is triggered unnecessarily several times**

- The radar sensor is dirty. Clean the radar sensor → page 355.
- The system limits have been exceeded → page 180.
- If the problem persists, switch off Front Assist and go to a correspondingly qualified workshop. Volkswagen recommends using a Volkswagen dealership.

above around 60 km/h (35 mph) within the system limits (system status active).

#### **⚠ WARNING**

The intelligent technology used in the lane keeping system cannot overcome physical limitations, and functions only within the limits of the system. Always take care when using the lane keeping system otherwise you could cause accidents or injuries. The system is not a substitute for the full concentration of the driver and their steering.

- Adapt your speed and distance from the vehicles ahead to suit visibility, weather, road and traffic conditions.
- Your hands should always be on the steering wheel so that you can steer at any time. The driver is always responsible for staying in the lane.
- Immediately override any undesired intervention by the system by steering.
- Observe the information on the instrument cluster display and respond according to the prompts, if permitted by the traffic situation.
- Always observe the area around the vehicle with care and watch the road ahead while driving.
- If the camera's field of view is dirty, covered or damaged, the function of the lane keeping system may be impaired.

## Lane keeping system (Lane Assist)

### Introduction to the topic



Within the system limits, the lane keeping system (Lane Assist) helps the driver to stay in lane. The function is not designed to keep the vehicle in lane automatically, nor is it suited to this purpose.

Using a camera behind the windscreen, the lane keeping system detects road lane markings on the road. If your vehicle moves too close to a recognised road lane marking, the system will warn the driver with a corrective steering intervention. The corrective steering intervention can be overridden by the driver at any time.

#### **Speed range**

When road lane markings can be detected, the lane keeping system is ready to intervene at speeds

### Limits of the lane keeping system

 Please refer to  at the start of the chapter on page 182.

#### **Road lane marking that are not detected or not detected correctly**

The lane keeping system cannot recognise all road lane markings correctly. The lane keeping system may not perform a control intervention if road lane markings are not detected. Be prepared to steer at all times.

Poor road surfaces, road structures or objects, reflections or dazzle effects on the road surface may be incorrectly interpreted as road lane markings. Immediately override any undesired intervention by the system.

#### **Temporarily switching off the lane keeping system**

In the following situations undesired intervention by the lane keeping system can occur or no control assistance is provided by the lane keeping system. This means that it is particularly important that the driver



is attentive in these situations: Switch off the lane keeping system temporarily:

- If the driving style is very dynamic.
- In poor weather conditions and when driving on poor roads.
- Driving through road works.
- Over crests or through dips.
- When not driving on motorways or well-developed country roads.

### **⚠ WARNING**

Failure to switch off the lane keeping system in the situations mentioned can result in accidents and serious injuries.

### **Lane keeping system not available**

The system is not available under the following conditions (passive system status):

- The vehicle speed is under 55 km/h (approximately 30 mph).
- The lane keeping system has not detected a road lane marking.
- In tight bends.
- Temporarily if the driving style is very dynamic.
- When the turn signal is switched on before changing lane manually.
- If the driver oversteers a system intervention.
- The driver does not react to a driver intervention prompt.

## **Driving with the lane keeping system**



📖 Please refer to **⚠** at the start of the chapter on page 182.

### **Switching on and off**

Depending on country, the lane keeping system is always switched on when the ignition is switched on. You can switch the lane keeping system on and off manually and view the activation status.

On the display of the instrument cluster:

1. Press the  button.
2. Switch the lane keeping system on or off.

 Depending on equipment, the  button is either on the multifunction steering wheel or on the turn signal lever.

In the Infotainment system:

1. Open the Assist systems menu.
2. Switch the lane keeping system on or off in the corresponding submenu.

The lane keeping system (Lane Assist) is also switched on when the semi-automated driving assistance (Travel Assist) is switched on.

 If there is a system fault, the lane keeping system can deactivate itself automatically.

### **Displays**

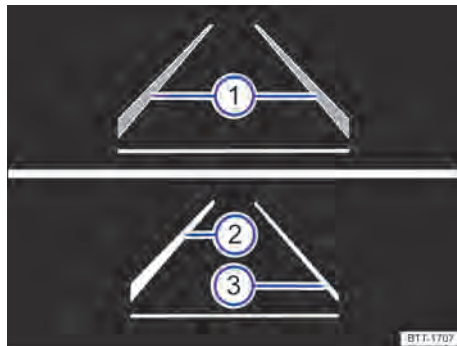



**Fig. 148** On the instrument cluster display: lane keeping system displays.

- ① Road lane markings detected. The system is ready to intervene on the side shown.
- ② Road lane markings detected. System is actively intervening on the indicated side.
- ③ The system is not ready to intervene on the side shown.

With some equipment levels, a display is also shown on the Head-up Display → page 30.

Depending on the situation and the instrument cluster version, one of following indicator lamps lights up:

 System is active and ready to perform control intervention.

 System is active and ready to perform control intervention.

 System intervention (corrective steering intervention).

 System intervention (corrective steering intervention).

If no warning lamp lights up, the system is not ready to intervene on either side (passive system status) or is switched off.

 If the semi-automated driving assistance (Travel Assist) is actively performing a control operation, there is no steering intervention and the lane keeping system is not displayed.

#### Driver intervention prompt

If there is no steering activity, the system prompts you to drive in the middle of your lane by means of acoustic warnings and a display on the instrument cluster.

If you do not react, the system will switch to passive state.

Depending on the equipment level, Emergency Assist may be activated.

Independently of steering activity, you will be additionally requested to drive in the middle of the lane again with a display on the instrument cluster display and with acoustic warnings if the corrective steering intervention takes place for an extended time.



#### Steering wheel vibration

The following situations can lead to vibration of the steering wheel:

- The system can no longer detect a lane during a major steering intervention.

You can also select the option **Vibration** or **Steering wheel vibration** in the Assist systems menu of the Infotainment system. In this case, the steering wheel will vibrate if the vehicle drives over a detected road lane marking when the lane keeping system is active. <

## Troubleshooting

 Please refer to  at the start of the chapter on page 182.

#### Fault message, lane keeping system not available

An indicator lamp lights up in the instrument cluster. A message will also appear on the instrument cluster display.

- The camera window is dirty. Clean the windscreen → page 355.
- The view of the camera is impaired due to the weather conditions, e.g. snow, or due to detergent deposits or coatings. Clean the windscreen → page 355.

- The view of the camera is impaired by add-on parts or stickers. Keep the area around the camera window free.
- The camera has been displaced or damaged, e.g. due to damage to the windscreen. Check whether damage is visible → page 362.
- Fault or malfunction. Switch off and restart the engine.
- If the problem persists, go to a correspondingly qualified workshop. Volkswagen recommends using a Volkswagen dealership.

 It can take a few seconds before a system fault is detected after the ignition is switched on.

 If the lane keeping system is not available, Emergency Assist is also not available.

 If the lane keeping system is not available, Travel Assist is also not available.

#### The system is not responding as expected

1. Do not attach any objects to the steering wheel. <

## Travel Assist

### Introduction to the topic

Within the system limits, Travel Assist allows the vehicle to maintain a distance from the vehicle in front that has been preselected by the driver and stay in the preferred position within the lane (adaptive lane guidance).

Travel Assist uses the same sensors as the Adaptive Cruise Control (ACC) and the lane keeping system (Lane Assist). You should therefore read the information on ACC and Lane Assist carefully and observe the listed system limits and instructions.

#### Does the vehicle have Travel Assist?

The vehicle is equipped with Travel Assist if the  button is available on the multifunction steering wheel.

#### Speed range

Travel Assist regulates at speeds between around 30 km/h (approximately 20 mph) and around 210 km/h (approximately 130 mph). Adaptive lane guidance can be used at speeds between 0 km/h (0 mph) and around 250 km/h (approximately 155 mph). This speed range may differ depending on country.

## Driving with Travel Assist

Travel Assist automatically regulates the speed and steers the vehicle. Within the system limits, Travel Assist can decelerate the vehicle to a standstill behind a vehicle that is stopping. It can also start driving again by itself.

You can override Travel Assist regulation at any time.

### Displays



**Fig. 149** On the instrument cluster display: active regulation displayed.

- ① Adaptive lane guidance active.
- ② Set distance, no vehicle detected ahead.

With some equipment levels, a display is also shown on the Head-up Display.

Depending on the vehicle equipment, indicator lamps on the instrument cluster display show the status of Travel Assist:



Travel Assist active, Adaptive Cruise Control and adaptive lane guidance active.



Travel Assist active, Adaptive Cruise Control active, adaptive lane guidance passive.

### Driver intervention prompt

If you take your hands off the steering wheel, the system prompts you within a few seconds to take over active steering by way of acoustic warnings and a display on the instrument cluster.

If you do not react to this, the system provides an additional warning by means of a short braking jolt.

Depending on equipment, the driver's seat belt is also briefly tensioned.

Travel Assist is then deactivated.

Alternatively, Emergency Assist will be activated (with some equipment levels).

## WARNING

The intelligent technology used in Travel Assist cannot overcome the physical limits specified, and functions only within the limits of the system. Careless or unintentional use of Travel Assist can cause accidents and serious injuries. The system is not a substitute for the full concentration of the driver.

- Adapt your speed and the distance from the vehicles ahead to suit visibility, weather, road and traffic conditions.
- Never use Travel Assist in poor visibility, on steep or winding roads, or on slippery road surfaces, e.g. due to snow, ice, wet roads, loose chippings, or on flooded roads.
- Never use Travel Assist offroad or on unsurfaced roads. Travel Assist is designed for use on surfaced roads only.
- Travel Assist does not react to persons, animals or vehicles crossing or approaching in the same lane.
- Take control of the vehicle immediately if requested to do so by a prompt on the instrument cluster display or if the speed reduction by Travel Assist is not sufficient.
- Brake if the vehicle starts moving unintentionally, e.g. after a driver intervention prompt.
- Your hands should always be on the steering wheel so that you are ready to steer at any time. The driver is always responsible for staying in the lane.
- Be prepared to control the speed yourself at all times.

## Operating Travel Assist

📖 Please refer to ⚠️ at the start of the chapter on page 184.





Fig. 150 Lefthand side of the multifunction steering wheel (Variant 1)



Fig. 151 Lefthand side of the multifunction steering wheel (Variant 2)

### Switching on and starting control

1. Press the  button on the multifunction steering wheel.

The green indicator lamp  lights up in the instrument cluster display. A message is also displayed. Travel Assist maintains the current speed and the preset distance from the vehicle in front. When lane markings are detected, the vehicle is simultaneously kept in the lane by steering movements.

### Cancelling control

1. Briefly press the  button.

**Or:** depress the brake pedal.

The set distance remains stored.

### Making other settings

The other operating functions of Travel Assist correspond to operation of ACC → page 175. <

## Troubleshooting

📖 Please refer to ⚠️ at the start of the chapter on page 184.

### Travel Assist is not available or does not function as expected

The indicator lamp lights up yellow. A message will also appear on the instrument cluster display.

- There is a fault in the sensor system. Check the causes and remedies described in the information on ACC or Lane Assist.
- Fault or malfunction. Switch off and restart the engine.
- The system limits have been exceeded.
- If the problem persists, go to a correspondingly qualified workshop. Volkswagen recommends using a Volkswagen dealership.

### Take over steering

The warning lamp lights up white and a message is displayed in the instrument cluster display.

You have released the steering wheel for a few seconds.

1. Take hold of the steering wheel and take over vehicle control.

### Take over steering immediately

The warning lamp lights up red and a message is displayed in the instrument cluster display. An acoustic warning is issued or the steering wheel vibrates, depending on the driving situation.

You have let go of the steering wheel for an extended time or the system limits have been reached.

1. Take hold of the steering wheel immediately and take over vehicle control.

### Travel Assist switches off automatically

#### – Vehicles without Emergency Assist:

You have released the steering wheel for an extended period of time.

- Fault or malfunction. Switch off and restart the engine.
- If the problem persists, go to a correspondingly qualified workshop. Volkswagen recommends using a Volkswagen dealership.

### Control is interrupted unexpectedly

- You have activated the turn signal.

## Semi-automated vehicle assistance in a medical emergency (Emergency Assist)

### Introduction to the topic

Emergency Assist can detect a lack of activity on the part of the driver and keep the vehicle in the lane automatically, or brake the vehicle to a standstill if required. The system can therefore actively contribute to preventing or reducing the consequences of an accident.



Emergency Assist uses the same sensors as the Adaptive Cruise Control (ACC) and the lane keeping system (Lane Assist). You should therefore read the information on ACC and Lane Assist carefully and observe the listed system limits and instructions.

### WARNING

The intelligent technology used in Emergency Assist cannot overcome the physical limits specified, and functions only within the limits of the system. The driver is always responsible for controlling the vehicle.

- Adapt your speed and distance from the vehicles ahead to suit visibility, weather, road and traffic conditions.
- Emergency Assist cannot always prevent accidents and serious injuries on its own.
- If the radar sensor or the front camera are faulty, covered or have been displaced, Emergency Assist may carry out unwanted braking or steering interventions.
- Emergency Assist does not react to persons, animals or vehicles crossing or approaching in the same lane.

## Driving with Emergency Assist

 Please refer to  at the start of the chapter on page 187.

### Switching on and off

When the ignition is switched on, Emergency Assist is active if the following prerequisites are met:

- The lane keeping system (Lane Assist) and Adaptive Cruise Control (ACC) are switched on.
- A position has been selected for driving forward.
- The system has detected a road lane marking on both the right and left sides of the vehicle.



If the lane keeping system (Lane Assist) is not available, Emergency Assist is also not available.

### Driver intervention prompt

If there is no driver activity, Emergency Assist prompts the driver to take control of the vehicle by acoustic warnings and by a braking jolt. A message will also appear on the instrument cluster display.

Depending on equipment, the driver's belt is also tensioned simultaneously.

### System intervention

If the driver does not respond, the system can brake the vehicle and keep it in lane. One of the following indicator lamps lights up in the instrument cluster display:



System intervenes.



System intervenes.

You can override intervention at any time by accelerating, braking or steering.

The hazard warning lights will be switched on after a short time to warn other road users if Emergency Assist is actively intervening.

If the remaining stopping distance is sufficient, the vehicle will be braked to a standstill if necessary. The electronic parking brake will then be switched on automatically.

### WARNING

If Emergency Assist is triggered unexpectedly, it can result in accidents and serious injuries.

- If the vehicle behaves differently to expected, cancel the intervention of Emergency Assist by accelerating, braking or steering.

- Switch off the lane keeping system (Lane Assist).
- Do not use Travel Assist.
- Go to a correspondingly qualified workshop and have the system checked. Volkswagen recommends using a Volkswagen dealership.

## Lane change system (Side Assist)

### Introduction to the topic

The lane change assist system (Side Assist) provides assistance when checking for traffic behind the vehicle.

Radar sensors monitor the area behind the vehicle. The system measures the distance and speed difference in relation to other vehicles and informs the driver by means of visual signals in the wing mirrors.

#### System limits

Use the lane change system only on surfaced roads.

The lane change system may interpret the traffic situation incorrectly in the following driving situations, for example:

- In tight bends.
- When driving in the middle of two lanes.
- When road lanes are of varying width.
- At crests in the road.
- In poor weather conditions.
- Where there are special roadside structures, e.g. high or offset crash barriers.

### WARNING

The intelligent technology used in the lane change system cannot overcome the physical limits specified, and functions only within the limits of the system. Do not let the increased convenience of the lane change system tempt you into taking any safety risks. Always take care when using the lane change system as you could otherwise cause accidents or injuries. The system is not a substitute for the full concentration of the driver.



- Adapt your speed and distance from the vehicles ahead to suit visibility, weather, road and traffic conditions.
- Your hands should always be on the steering wheel so that you can steer at any time.

- Observe the displays in the exterior mirror housings and on the instrument cluster display and act in accordance with the requests.
- Always pay attention to what is happening around the vehicle.
- Never use the lane change system if the radar sensors are dirty, covered or damaged. These circumstances can impair the proper functioning of the system.
- It may be hard to see the display in the wing mirror in direct sunlight.

 Some settings can be stored in the user accounts of the personalisation function and therefore change automatically when the user account changes → page 41.

 The radar sensors calibrate themselves once in the first few kilometres after vehicle delivery and if the sensors are repaired. The sensor range may be limited during the calibration phase.

### Driving with the lane change system



 Please refer to  at the start of the chapter on page 188.

#### Switching on and off

You can view the activation status of the lane change system on the instrument cluster display and in the Infotainment system. You can also switch the lane change system on and off there.

On the display of the instrument cluster:

1. Press the  button.
2. Switch the lane change system on or off.

 Depending on equipment, the  button is either on the multifunction steering wheel or on the turn signal lever.

Depending on equipment, in the Infotainment system:

1. Open the Assist systems menu.
2. Switch the lane change system on or off in the corresponding submenu.



**Fig. 152** In the exterior mirror housing: visual displays of the lane change system.

When the lane change system is switched on, the yellow indicator lamp  in the exterior mirror lights up once briefly.

#### Function

When switched on, the lane change system is active from a speed of around 15 km/h (9 mph). The lane change system is deactivated at a vehicle speed below 10 km/h (6 mph).

The yellow indicator lamp  in the exterior mirror lights up in the following situations:

- If your vehicle is being overtaken.
- When overtaking another vehicle with a speed difference of up to approximately 15 km/h (9 mph). No display will be shown if the overtaking manoeuvre is much faster.

The yellow indicator lamp  in the exterior mirror flashes if a possible critical situation is detected when you indicate in the direction of the detected vehicle.

The faster another vehicle approaches, the earlier there is a corresponding display in the exterior mirror.

#### Lane change system “Side Assist Plus”

If the vehicle is equipped with a lane keeping system (Lane Assist) and the system is switched on, the driver is warned by a corrective steering intervention when changing lanes during a possible critical situation (information level, warning level). The steering intervention also occurs when the turn signal is activated for the corresponding direction. If the steering intervention is overridden by the driver, the steering wheel vibrates to give an additional warning.

#### Automatic deactivation

The lane change system will switch off automatically if the radar sensors are permanently covered. This can, for example, be caused by a layer of ice or snow in front of the radar sensor.

A text message will be shown on the instrument cluster display.

If the lane change system has been automatically deactivated, the system cannot be activated until the ignition has been switched off and back on again.



If you use the factory-fitted trailer towing coupling and have set up the necessary electrical connection, the lane change system switches off automatically. After you have disconnected the electrical connection, the lane change system is switched back on automatically. If the trailer towing coupling is not factory-fitted, you must manually switch off the lane change system and then switch it back on again.

#### Brightness

The brightness of the visual display will change automatically depending on the ambient light levels.

You can adjust the basic brightness of the display in the Assist systems menu in the Infotainment system. The lane change system is not active during the setting procedure. 

## Troubleshooting

 Please refer to  at the start of the chapter on page 188.

### Lane change system fault

Fault or malfunction. The indicator lamp lights up yellow. The yellow central warning lamp  also lights up.

1. Go to a correspondingly qualified workshop. Volkswagen recommends using a Volkswagen dealership.

### No sensor visibility, fault message, system switches itself off

- Clean radar sensors and remove stickers or accessories from radar sensors → page 357.
- Check for any visible damage.
- If the problem persists, go to a correspondingly qualified workshop. Volkswagen recommends using a Volkswagen dealership.

### The system is not responding as expected

- The radar sensors are dirty → page 357. The sensor visibility may be impaired by dirt and snow or also residue from cleaning agents or coatings.
- The general conditions for system operation have not been met → page 188.

- The radar sensors are covered by water.
- The vehicle is damaged in the area of the radar sensors, e.g. due to parking collisions.
- The detection ranges of the radar sensors are blocked by add-on parts, e.g. bicycle carriers.
- Changes have been made to the paintwork in the area of the radar sensors or structural modifications have been made, e.g. on the vehicle front end or the running gear.
- The side windows have been retrofitted with tinted window films.
- If the problem persists, go to a correspondingly qualified workshop. Volkswagen recommends using a Volkswagen dealership.

## Parking and manoeuvring



### Parking

#### Parking the vehicle

##### **WARNING**

If the vehicle is not parked properly it can roll away even on a slight gradient. This can cause accidents and serious injuries.

- When parking, observe the specified order.
- Before leaving the vehicle, make sure that the electronic parking brake is switched on and that the indicator lamp  lights up red on the instrument cluster display when the ignition is switched off.
- *Ignition lock:* Never remove the vehicle key from the ignition if the vehicle is in motion. This could cause the steering lock to engage suddenly. You will no longer be able to steer the vehicle.

1. Depress and hold the brake pedal.  
With a manual gearbox, depress the clutch pedal *fully* or disengage the clutch.
2. With an automatic gearbox, engage the parking lock P.
3. Switch on the electronic parking brake.
4. On uphill and downhill slopes, turn the steering wheel so that the vehicle will roll against the kerb if it starts to move.
5. Stop the engine and switch off the ignition.  
The indicator lamp  in the instrument cluster display lights up red.
6. With a manual gearbox, select first gear for flat ground and uphill gradients, or reverse gear for downhill gradients, and then release the clutch.
7. Release the brake.
8. To engage the steering lock, turn the steering wheel slightly if necessary.
9. Get out of the vehicle → . Watch out for other road users!
10. Take all vehicle keys with you and lock the vehicle.

##### **WARNING**

If children, people requiring assistance or animals are left unattended in the vehicle, there is the danger of accidents and serious injuries.



- Never leave children, people requiring assistance or animals in the vehicle unattended. They could operate the selector lever and switch off the electronic parking brake as a result. The vehicle could start to move.
- Never leave children, people requiring assistance or animals in the vehicle. Depending on the time of year, very high or very low temperatures can occur inside a closed vehicle.
- Always take all vehicle keys with you every time you leave the vehicle.

To avoid damage and dangerous situations, always park the vehicle in a suitable parking space → ①.

#### ! NOTICE

The vehicle cannot be parked safely and can be damaged if the ground is uneven, sandy or muddy.

- Always park the vehicle on a firm, level surface.

#### ! NOTICE

Low-lying vehicle components such as the bumpers, spoiler and parts of the running gear can be damaged if the vehicle drives over objects protruding from the ground.

- Drive carefully over drives, ramps, kerbs, borders and dips.

## Electronic parking brake

### Operating the electronic parking brake



**Fig. 153** In centre console: button for the electronic parking brake.

### Switching on

1. When the vehicle is stationary, pull and hold the button for the electronic parking brake → Fig. 153 ②.

The indicator lamp in the ② button lights up yellow.

- ③ The indicator lamp in the instrument cluster lights up red when the electronic parking brake is switched on.

### Switching off

1. Switch on the ignition.
2. Depress the brake pedal and press the ④ button.

**Or:** when the engine is running, gently press the accelerator without pressing the brake pedal.

The indicator lamp in the ④ button and the red indicator lamp ⑤ in the instrument cluster go out.

### Automatic switch-on if the driver does not leave the vehicle correctly

If the system detects that the driver has not left the vehicle correctly in vehicles with an automatic gearbox or DSG® dual clutch gearbox, the electronic parking brake may switch itself on automatically → ⚠.

### ! WARNING

If not parked properly, the vehicle may roll away. This can cause accidents, serious injuries and damage to property.

- Always park the vehicle in the specified order → page 190, *Parking*.
- Before leaving the vehicle, make sure that the electronic parking brake is switched on and that the indicator lamp ② lights up red on the instrument cluster when the ignition is switched off.

### Automatic switch-off when driving off

The electronic parking brake is released automatically when driving off if one of the following situations occurs when the driver door is closed → ⚠:

- *Manual gearbox:* The clutch is depressed fully before driving off.
- *DSG dual clutch gearbox:* A position is engaged or changed.

### Moving off on steep uphill gradients or with increased vehicle weight

You can prevent the electronic parking brake from switching off automatically by pulling the  button upwards and holding it while pulling away.

If higher engine power is required to move off, the electronic parking brake will be deactivated only when you release the  button.

This can make it easier to move off with a high maximum trailer weight.

### Emergency braking function

The emergency braking function should be used only in those situations where the vehicle cannot be stopped using the foot brake → .

1. Pull and hold the .

The vehicle brakes strongly. An acoustic warning sounds at the same time.

### WARNING

Incorrect use of the electronic parking brake can cause accidents and serious injuries.

- To brake the vehicle, always use the foot brake, never the electronic parking brake, except in an emergency. The braking distance is considerably longer as only the rear wheels are braked in some cases.
- If the vehicle is to be kept stationary, do not press the accelerator when the engine is running and a gear is engaged. The electronic parking brake may become released and the vehicle could start moving.

## Troubleshooting

### Holding force is insufficient in the current situation

The  indicator lamp flashes red.

It is not possible to park the vehicle safely.

1. Park the vehicle in a different place or on a level surface.

### / Fault in electronic parking brake

The central warning lamp lights up yellow. The  symbol with a text message is additionally shown on the instrument cluster display.

1. Go to a correspondingly qualified workshop. Volkswagen recommends using a Volkswagen dealership.

### Electronic parking brake does not switch itself off

- The prerequisites for switching off the electronic parking brake are not met → page 191.
- The 12-volt vehicle battery is discharged → page 303.

### Electronic parking brake makes noises

Noises may be heard when the electronic parking brake is switched on and off.

If the electronic parking brake has not been used for a long period, the system will carry out occasional automatic and audible checks when the vehicle is parked. 

## Auto Hold function



Fig. 154 In the centre console: button for the Auto Hold function.

The Auto Hold function secures the vehicle against rolling away when stationary, without the vehicle having to be held by the foot brake.

### Requirements

- ✓ The driver door is closed.
- ✓ The engine is switched on.

If position **N** is selected, the Auto Hold function will not switch on or will switch itself off. As a result, the vehicle will not be held securely in a stationary position → .

### Switching on

1. Press the  button → Fig. 154.

The indicator lamp in the  button lights up yellow.

Auto Hold is ready for use, but the car is not necessarily stopped → .

The Auto Hold function remains active when the ignition is switched on again.

### Keeping the vehicle stationary with the Auto Hold function

1. Bring the vehicle to a standstill using the brake with the Auto Hold function switched on → page 190.

*Manual gearbox:* Either keep the clutch *fully* depressed or shift to neutral.

2. Release the brake pedal → .

The vehicle will be kept stationary.

 The indicator lamp in the instrument cluster lights up green when the Auto Hold function is active.

The hold function stops if the vehicle is driven off or if the prerequisites for the Auto Hold function are not met.

### Switching off

1. Press the  button → .

The indicator lamp in the  button → Fig. 154 goes out.

The electronic parking brake switches on automatically to hold the vehicle securely.

However, the electronic parking brake will not switch on if the brake pedal is depressed when the Auto Hold function is switched off → .

### Switching off temporarily with the button

When manoeuvring, it may be necessary to turn the Auto Hold function off once temporarily to enable the vehicle to roll more easily.

1. With the engine switched on, depress the brake pedal.
2. Press the  button.

The Auto Hold function is switched off.

The Auto Hold function will be reactivated as soon as the brake pedal is depressed when the vehicle has come to a standstill.

### WARNING

The intelligent Auto Hold function cannot overcome the laws of physics, and operates only within the limits of the system. Do not let the extra convenience afforded by the Auto Hold function tempt you into taking any safety risks when driving.

- If the vehicle is to be held very securely, make sure that the indicator lamp for Auto Hold or for the electronic parking brake on the instrument cluster display lights up.

- Never leave the vehicle while the engine is running and with the Auto Hold function switched on.
- The Auto Hold function cannot hold the vehicle in all hill start situations or brake it sufficiently on all slopes going downhill, e.g. if the ground is slippery or icy.

### NOTICE

Automatic switch-on of the electronic parking brake in a car wash can cause damage.

- Always switch off the Auto Hold function before driving into a car wash. 

## Information about the parking systems

### Safety notes

#### WARNING

The intelligent technology used in the parking systems cannot overcome the laws of physics, and functions only within the system limits. Never let the extra convenience afforded by the parking systems tempt you into taking any risks when driving. The parking systems cannot replace the full concentration of the driver.

- Ensure that your speed and driving style are always appropriate for the current visibility, weather and road/traffic conditions.
- Keep looking in the direction in which you are parking and at the relevant area surrounding the vehicle. Pay special attention to small children, animals and objects.
- Please note that the parking system may not be able to react if the obstacle is approached too fast and will then not issue a warning.
- Do not allow the parking system displays to distract you from the traffic around you.

#### WARNING

Camera lenses enlarge and distort the field of view. Using images from the camera to estimate the distance from persons or obstacles can be inaccurate and may cause accidents and serious injuries.

- Do not rely on the camera image.

## NOTICE

Observe a distance of 50 cm (20 inches) from walls and buildings in parking spaces without kerbs in order to avoid damage to the vehicle.

### Limits of sensors and cameras

There are various sensors and cameras on the vehicle which detect and monitor the area around the vehicle by means of ultrasound, radar waves and optical systems. The various parking systems use different combinations of the sensors. Common to all sensors is the fact that they are subject to technical and physical limits → .

- Some objects may not be detected under certain circumstances, such as trailer drawbars, thin bars, fences, posts, trees, very low or high obstacles, as well as open or opening boot lids → .
- The detection ranges of the parking systems have blind spots in which obstacles and people are not registered.
- In some cases, dirt or ice and water on the sensors and cameras could be registered as an obstacle or impair detection of objects. The sensor visibility may be impaired by dirt and snow, as well as residue from cleaning agents or coatings → page 197.
- External sources of sound and certain surfaces on objects and clothing may influence the sensors' signals. In certain circumstances, the systems will be unable to detect or properly detect people and objects.
- Certain objects, for example narrow posts or railings, may be difficult or impossible to see on the screen because of its low resolution or poor light conditions.
- The cameras show only two-dimensional images on the screen. The lack of depth of field means that potholes and protruding objects on the ground may only be detected with difficulty, or may not be detected at all.

 Volkswagen recommends that drivers practise using the parking systems in a traffic-calmed area or car park to allow them to familiarise themselves with the systems and their functions.

## Requirements

- ✓ The doors and boot lid are closed.
- ✓ Exterior mirrors are not folded in.
- ✓ The sensors or cameras are not covered by add-on parts or trim frames for number plates. The

trim frame or number plate must not project at the sides or downwards.

- ✓ The surrounding area has a flat surface.
- ✓ Vehicle does not have a heavy load at the rear or on one side.
- ✓ Engine running.
- ✓ Brake support systems such as ESC or TCS are switched on.

 The parking function and the acoustic warnings will be deactivated if other functions are operated on the Infotainment system during a parking operation.

### Finding a suitable parking space

- ✓ The length and width of the parking space must be larger than the vehicle dimensions and offer sufficient space for manoeuvring.
- ✓ The distance when driving past the parking space should be around 1 m (around 3 ft).
- ✓ **Vehicles with Park Assist:** The maximum speed when driving past *parking spaces parallel to the road* maximum around 40 km/h (around 25 mph) and for *parking spaces perpendicular to the road* maximum around 20 km/h (around 12 mph).

## Parking system displays in the Infotainment system

The choice of parking displays and Infotainment system settings varies depending on the country and the vehicle equipment.

*USA and Canada:* When the camera image of a parking system is switched on by engaging reverse gear, no function buttons are shown for safety reasons. These function buttons can be made visible again by tapping the  function button.

### General displays

 Mute audio signals.

 Adjust brightness, contrast and colour.

 Show display.

 Hide display.

## X

Close current display and end function.

### Park Distance Control displays

 Switch the manoeuvre braking function off or on.

 Red-coloured image segment: close obstacle. **The vehicle is at risk. Brake.**

 Yellow-coloured image segment: obstacle in the vehicle path. **The vehicle is at risk. Adjust the steering wheel angle.**

 White or grey-coloured image segment: obstacle outside the path of the vehicle.

 System fault in the monitored area (depending on equipment level). The colour may vary.

 Switch to rear view camera system.

### Rear view camera system displays (with parking mode selection)

 Switch to perpendicular parking mode.

 Switch to parallel parking mode.

 Turn the steering wheel (parallel parking mode).

 Stop the vehicle (parallel parking mode).

 Switch to crossing traffic parking mode.

 Switch to trailer support or off-road support parking mode (country-dependent).

 Red line: boundary or vehicle safety clearance.  
Red frame: outline of the vehicle (parallel parking).

 Yellow lines: vehicle path depending on the steering angle.  
Yellow auxiliary box: front and rear boundaries of the parking space (parallel parking).

 Green horizontal lines: boundaries.  
Green lateral line: turning point when driving into a parking space (parallel parking).

Green frame: outline of the vehicle (parallel parking).

 Switch to Park Distance Control.

### Park Assist displays

 Switch Park Assist on and off.

### Area View displays

 Front perpendicular parking.

 Rear perpendicular parking.

 Front crossing traffic.

 Rear crossing traffic.

 Terrain.

 Display both areas next to the vehicle simultaneously.

 Display driver side only.

 Display front passenger side only.

 Switch to trailer or off-road support (country-dependent).

 3D views.

 Switch to top view of the vehicle and surroundings.

 View of the vehicle and surrounding area from above (3D view).

 Slanted view of the vehicle and surrounding area from above (3D view).

 Vehicle and surrounding area are shown at an angle from the side (3D view).

### NOTICE

Visual and acoustic warnings are given only for obstacles in the vehicle path.

- Brake the vehicle no later than when the penultimate segment of an obstacle indicator appears or a continuous acoustic warning sounds.

 In the camera image, the guiding lines are shown by the system regardless of the vehicle surroundings. No automatic detection of obstacles by cameras takes place. Drivers must judge for themselves whether the vehicle will fit into the parking space.

 All of the reversing camera's guiding lines are hidden when the factory-fitted towing bracket is connected electrically to a trailer.

 All of the reversing camera's guiding lines are hidden when the boot lid in which the camera is installed is opened.

## Automatic braking intervention

The automatic braking intervention of a parking system is designed to reduce the possible damage due to a collision if an obstacle is detected during the parking manoeuvre.

### WARNING

Do not let the parking systems' automatic braking intervention tempt you to take any risks while driving. In some situations, the automatic braking intervention can only work in a limited way or not at all. Collisions with obstacles can cause injuries to persons and vehicle damage. The system is not a substitute for the full concentration of the driver.

- Always pay due attention and do not rely exclusively on the parking systems.
- Always be prepared to brake and steer the vehicle yourself.
- Do not take any safety risks.
- React appropriately to the warnings and driving recommendations of the parking systems.

### Requirements

- ✓ The vehicle speed does not exceed a maximum of around 10 km/h (around 6 mph) when manoeuvring.
- ✓ A parking system was switched on.

### What happens when an automatic braking intervention takes place?

The vehicle is braked to a standstill and then held for around 2 seconds if it encounters an obstacle.

1. Hold the vehicle with the foot brake after an automatic braking intervention.

*Park Assist:* the vehicle is braked if it is travelling too fast. The parking manoeuvre can then be continued.

### Switching on and off

Automatic braking intervention is activated or deactivated as soon as the driver switches a parking system on or off.

1. Tap the  function button on the Infotainment system screen to switch manoeuvre braking on or off manually.

### Manoeuvre braking function of Park Distance Control

1. Briefly press the accelerator to cancel the automatic braking intervention → .

The automatic braking intervention does not take place for an obstacle in the front area if Park Distance Control has been activated automatically when driving forwards → page 198.

### Manoeuvring with the trailer manoeuvring system (Trailer Assist)

An automatic braking intervention can take place in the following situations:

- Speed exceeded.
- Steering interventions by driver.
- Diver door is open.
- The  button is pressed.

Depress and hold the brake pedal after the automatic braking intervention.

### Things to note for trailer towing

The automatic braking intervention at the rear of the vehicle is deactivated if the vehicle detects that a trailer is connected electrically.

 Switch off the parking system if automatic braking intervention occurs too frequently, for example when driving off-road.

 If the vehicle has been braked by the manoeuvre braking function of Park Distance Control, the function is inactive for around 5 m (around 16 ft) in the same direction of travel or will be ready for use again after the gear or drive position has been changed.

 The parking manoeuvre will be aborted after emergency braking by Park Assist due to an obstacle.

 After emergency braking by the Rear Traffic Alert, around 10 seconds must elapse before automatic braking intervention can take place again. <

## Troubleshooting

### The parking system is not responding as expected

- The prerequisites for system operation are not met → page 194.
- The sensors or the camera are dirty or iced-up → page 357.
- The camera lens is not clean and the camera image is unclear → page 357.
- The ultrasound signal is subject to interference from external noise sources, e.g. pneumatic drills or cobblestones.
- The vehicle is damaged in the area around the sensors or the camera – this may be caused by parking collisions or changes made to the paintwork or structural modifications in the area of the sensors or the camera, such as on the vehicle front end or the running gear.
- The detection range of the sensors or camera is blocked by add-on parts, e.g. bicycle carriers.

### Fault displays

1. Observe the text messages on the instrument cluster display and in the Infotainment system.

### ! NOTICE

In the event of a fault in the parking system, go to a correspondingly qualified workshop immediately. Volkswagen recommends using a Volkswagen dealership.

### No sensor or camera view, or the parking system has been switched off

The sensor area is switched off permanently if a sensor fails. The affected sensor area can be displayed by the  symbol in the Infotainment system. The parking system may be switched off completely.

If there is a fault in the Park Distance Control, a signal tone will sound for several seconds when it is switched on. A text notification may also be shown on the instrument cluster display.

1. Check whether one of the listed causes is present.
2. Switch the system on again once you have rectified the source of the fault.
3. If the issue persists, go to a suitably qualified workshop. Volkswagen recommends using a Volkswagen dealership.

### Park Assist cancels parking automatically

Park Assist cancels the parking manoeuvre in the following situations:

- Function button  is pressed.
  - The driver intervenes using the steering wheel.
  - The driver door is opened.
  - The time limit or number of manoeuvres for parking are exceeded.
  - TCS is switched off or is taking corrective action.
  - There is a system fault.
1. Restart the parking procedure.

### Park Assist is active and supports steering movements when the vehicle is stationary

If Park Assist attempts to turn the steering wheel when the vehicle is stationary, the white symbol  appears on the instrument cluster display.

1. Depress the brake pedal.

### Park Assist parks inaccurately after a wheel change

If Park Assist does not park correctly after a wheel change (e.g. vehicle is too far away or too close to the kerb), the system may have to adopt the new wheel circumferences.

1. Drive a longer distance with the vehicle, including curves.

Park assist automatically learns the new wheel circumferences. 

## Park Distance Control

### 📖 Introduction to the topic

Park Distance Control assists the driver when parking and provides warnings about obstacles.

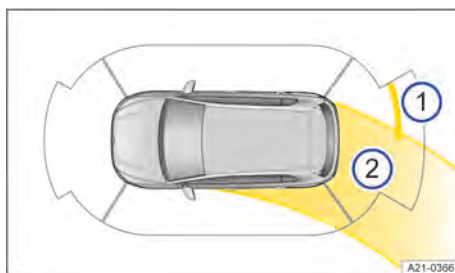

Fig. 155 Infotainment system: Park Distance Control display (illustration).

- ① Obstacle detection.

## ② Steering wheel angle.

### Function

Park Distance Control detects the distance from an obstacle by means of sensors in the front and rear areas of the vehicle.

Park Distance Control warns about an obstacle by means of colour segments on the Infotainment system screen and acoustic signals → Fig. 155, → ⓘ.

An automatic braking intervention can take place if the driver does not react when an obstacle is approaching (depending on equipment) → ⚠.

### ⚠ WARNING

The intelligent technology used in the parking systems cannot overcome the laws of physics, and functions only within the system limits. If this is not observed, this can result in accidents, serious injuries and also damage to the vehicle.

- The parking system is not a substitute for the full concentration of the driver.
- Brake the vehicle in good time when faced with an obstacle.

### ⓘ NOTICE

Do not drive on! The collision area has been reached when the penultimate segment is displayed, if not before.

### ⓘ NOTICE

With some equipment levels, distances to obstacles in the side areas are also displayed. The vehicle must be moved a few metres forwards or backwards in order to scan and display the side areas in full. An obstacle entering these areas from the outside will not be displayed.

### Park Distance Control settings

Depending on the vehicle equipment, settings for Park Distance Control can be made in the vehicle settings in the Infotainment system → page 37.

### Things to note for trailer towing

The rear sensors of Park Distance Control are not switched on if a trailer is electrically connected:

- No warnings are given for obstacles.
- The manoeuvre braking function is also automatically deactivated.

### Personalisation

Some Park Distance Control settings, e.g. the volume of the acoustic signals, can be stored in the personalised user accounts. The settings change au-

tomatically when the user account is changed → page 41. <



## Switching Park Distance Control on and off

📖 Please refer to ⚠ and ⓘ on page 193 and ⚠ and ⓘ at the start of the chapter on page 197.





Fig. 156 In the centre console: button for Park Distance Control.

### Switching on

1. Select reverse gear.
  - Or: press the  button → Fig. 156.
  - Or: press the  button.
  - Or: the vehicle rolls backwards.

### Switching off

1. Press the  button → Fig. 156.
  - Or: press the  button.
  - Or: move the selector lever to position P.
  - Or: the vehicle drives forwards at a speed of more than around 10 km/h (around 6 mph) to around 15 km/h (around 9 mph).

### Automatic activation when driving forwards

Park Distance Control switches itself on automatically if the vehicle approaches an obstacle when driving forwards slowly.

1. Switch the function on or off in the vehicle settings of the Infotainment system → page 37.

There is no further automatic activation if Park Distance Control is switched off by the driver.

Automatic activation is available again under the following conditions:





– The vehicle was accelerated to over a speed of around 15 km/h (around 9 mph) and then slowed down below this speed again.

**Or:** the ignition was switched off and then back on again.

**Or:** a position was selected from the parking lock position **P**.

 If an obstacle is detected in front of the vehicle, the display on the Infotainment system is activated first. Acoustic signals are output additionally if the vehicle continues to approach the obstacle.

 **Trailer support** or **Offroad support** (depending on the country): Shows the area directly behind the vehicle with an enhanced zoom factor and guidelines.

 **Crossing traffic:** Shows a wide-angle view of the area behind the vehicle and the side areas.

1. Observe information about the on-screen displays of the rear view camera system  
→ page 194, *Parking system displays in the Infotainment system*.

## Rear view camera system

### Introduction to the topic

The rear view camera system in the rear of the vehicle makes it easier for the driver to see behind the vehicle and provides support for parking manoeuvres.

#### Function

The rear view camera system shows the area behind the vehicle on the Infotainment system screen. Depending on the operating mode and equipment level, orientation lines aid the view to the rear → .

### WARNING

The intelligent technology used in the parking systems cannot overcome the laws of physics, and functions only within the system limits. If this is not observed, this can result in accidents, serious injuries and also damage to the vehicle.

- The parking system is not a substitute for the full concentration of the driver.
- Brake the vehicle in good time when faced with an obstacle.

#### Parking mode selection

The Infotainment system displays depend on the equipment.

 **Perpendicular parking:** Orientation lines provide support when reversing into a parking space at right angles to the road.

 **Parallel parking:** Guidelines and boxes help with reverse parking parallel to the side of the road.

## Switching the rear view camera system on and off

 Please refer to  and  on page 193 and  at the start of the chapter on page 199.

#### Switching on

*Variant 2: rear view camera system with parking mode selection*

1. Select reverse gear.

**Or:** press the  button.

#### Switching off

*Variant 2: rear view camera system with parking mode selection*

1. The vehicle drives forwards at a speed of more than around 15 km/h (around 9 mph).

**Or:** press the  button.

## Driving into a parking space (rear view camera system with parking mode selection)

Please refer to ▲ and ① on page 193 and ▲ at the start of the chapter on page 199.

### Parking mode: parking perpendicular to the road

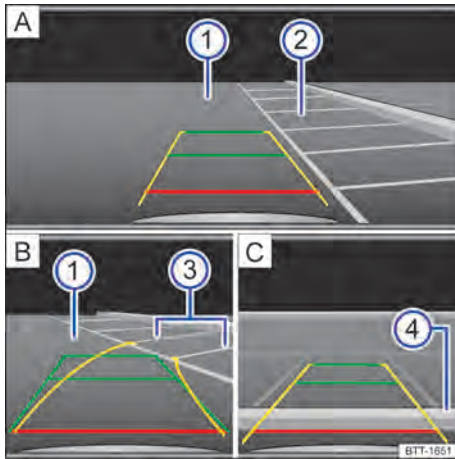

**Fig. 157** Infotainment system: parking perpendicular to the road.



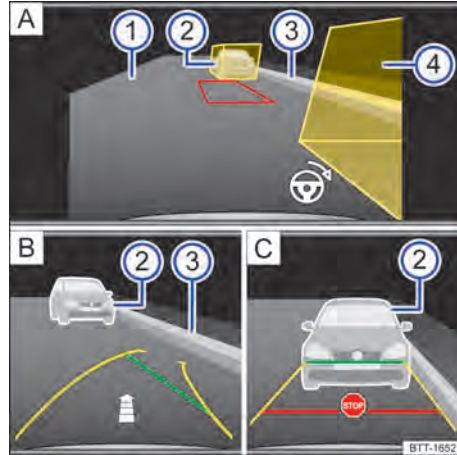

- A** Choose parking space.
  - B** Drive towards the selected parking space.
  - C** Align the vehicle in the parking space.
- ① Road.
  - ② Parking space.
  - ③ Side limit of the parking space.
  - ④ Rear limit of the parking space.
1. Press the **[Pw]** button or function button before driving past the parking space.
  2. Tap the **[Pw]** function button in the Infotainment system to select the parking mode.
  3. Position the vehicle in front of the parking space → Fig. 157 **A** ②.
  4. Steer so that the yellow lines lead into the parking space. The green and yellow lines must be aligned with the side limit lines → Fig. 157 **B** ③.
  5. Stop when the red line reaches the rear limit → Fig. 157 **C** ④.

### Parking mode: parking parallel to the road



**Fig. 158** Infotainment system: parking parallel to the road.

- A** Choose parking space.
  - B** Drive towards the selected parking space.
  - C** Align the vehicle in the parking space.
- ① Road.
  - ② Obstacle or auxiliary box.
  - ③ Side limit of the parking space.
  - ④ Obstacle or auxiliary box.
1. Press the **[Pw]** button or function button before driving past the parking space.
  2. Tap the **[Pw]** function button in the Infotainment system to select the parking mode.
  3. Operate the turn signal for the relevant side of the road.
  4. Position the vehicle at a distance of approximately 1 m (3 ft) parallel to the parking row. The yellow auxiliary boxes must cover the obstacles → Fig. 158 **A** ② and ④. The area in between must be free of obstacles.
  5. Select reverse gear. A red frame shows the target position of your vehicle → Fig. 158 **A**.
  6. Turn the steering wheel until that the red frame moves between the auxiliary boxes and turns green → Fig. 158 **A**. Leave the steering wheel in this position while reversing.
- If a change has to be made to the steering wheel angle, one of the yellow lateral lines will turn red. The steering wheel symbol  shows the driver when the steering wheel angle has to be changed.

7. Reverse slowly until the stop sign  is displayed or the green line is aligned with the side limit of the parking space → Fig. 158 . An arrow → Fig. 158  shows the remaining distance to be covered according to the number of segments shown.
8. Stop the vehicle. Steer in the opposite direction until the steering angle is reached and the direction arrow is no longer displayed.
9. Continue reversing until the stop symbol  is displayed or until the red line reaches the rear limit.

### Parking mode: trailer support

Rear view camera system with parking modes:

In vehicles with a factory-fitted towing bracket, the trailer support function can be used when approaching a trailer drawbar.

1. Tap the  function button to select the parking mode.

Coloured guide lines assist the manoeuvring process:



Red lines: position of towing bracket.



Green lines: distance to towing bracket.



Orange line: predicted path of the towing bracket, depending on the steering angle.

## Park Assist

### Introduction to the topic

Park Assist shows parking spaces that are suitable for parking and assists the driver when driving into and out of parking spaces.

#### Function

Park Assist is an extension of Park Distance Control → page 197.

Park Assist steers the vehicle into a parking space, while the driver operates the accelerator and brake and changes gear → .

### WARNING

The intelligent technology used in the parking systems cannot overcome the laws of physics, and functions only within the system limits. If this is

not observed, this can result in accidents, serious injuries and also damage to the vehicle.

- Pay careful attention to the parking procedure and the traffic around you. Keep looking in the direction in which you are parking.
- Use the foot brake to slow the vehicle in a hazardous situation.

#### Available functions

- Display suitable parking spaces.
- Select a parking mode.
- Drive into suitable parallel and bay parking spaces.
- Drive out of a parallel parking space.

### NOTICE

Park Assist uses parked vehicles, the kerb and other objects for orientation. Please ensure that the wheels and tyres are not damaged when parking the vehicle.

- If necessary, end the parking process before it is complete.



Any equipment that has been retrofitted to the vehicle, e.g. bicycle carriers, can prevent Park Assist from functioning properly and may cause damage.



During parking manoeuvres, the vehicle may be braked if the driver accelerates too strongly.

#### Things to note for trailer towing

The parking system cannot be activated if a trailer is electrically connected to the vehicle.

## Looking for a parking space

📖 Please refer to ▲ and ⌚ on page 193 and ▲ and ⌚ at the start of the chapter on page 201.



Fig. 159 In the centre console: button for Park Assist.

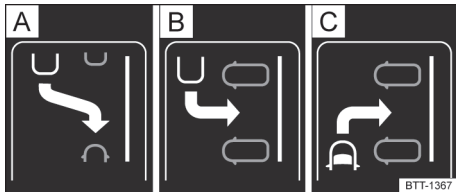

Fig. 160 In the instrument cluster display: parking modes for parking.

- A Reverse parallel parking.
- B Reverse perpendicular parking.
- C Forward perpendicular parking.

### Looking for a parking space

- Press the **P** button → Fig. 159.  
The indicator lamp lights up yellow and the park function is active.
- Drive slowly past a row of parked vehicles, paying attention to the traffic.  
Park Assist automatically searches for a suitable parking space.  
**Or:** operate the turn signal to search for a parking space on the opposite side of the road.  
A parking mode is displayed when a parking space is detected → Fig. 160.
- If, for example, you wish to park in a perpendicular parking space in a forward direction, press the **P** button and select parking mode → Fig. 160 C.

**Or:** press the **P** button multiple times to select one of several displayed parking spaces in sequence.

### ⚠️ WARNING

There is a risk of an accident if a function other than the parking function is selected and used on the Infotainment system during manoeuvring with Park Distance Control or Park Assist. All active parking functions and the acoustic warnings are switched off in this case. This means that no warnings are given about a possible collision and no preventive interventions take place.

- When manoeuvring, do not use any other function of the Infotainment system than the active parking function.

**i** Park Assist can be activated retrospectively. If the vehicle has previously driven past a suitable parking space, it will be displayed. <

## Driving into a parking space

📖 Please refer to ▲ and ⌚ on page 193 and ▲ and ⌚ at the start of the chapter on page 201.

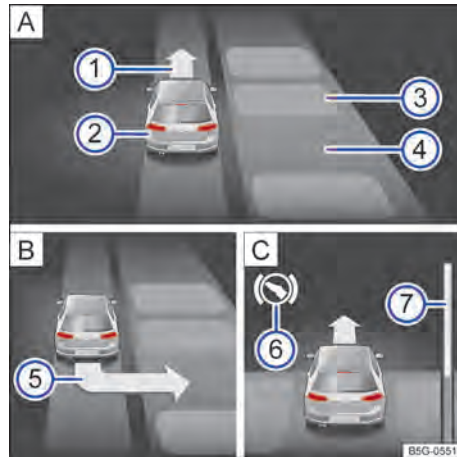



Fig. 161 On the instrument cluster display: parking perpendicular to the road.

- A Choose parking space.
  - B Drive into a parking space.
  - C Manoeuvre in the parking space
- Prompt to drive forward.
  - Your vehicle.

- ③ Parked vehicle or obstacle.
- ④ Detected parking space.
- ⑤ Prompt to reverse.
- ⑥ Prompt to brake.
- ⑦ Progress bar (remaining relative distance).





1. Stop the vehicle in front of or behind the parking space.
2. Observe the prompt to drive into a parking space on the instrument cluster display → Fig. 161 ⑤.
3. Select reverse gear when a reverse arrow appears on the instrument cluster display.
4. Release the steering wheel.
5. Release the brake.
6. Text message **Steering intervention active!**. Observe **Monitor vehicle area.** on the instrument cluster display.
7. Accelerate carefully.
8. Brake when an acoustic signal sounds, the  indicator lights up or a text message appears on the display in the instrument cluster.
9. To ensure the best possible result, always wait until Park Assist has finished turning the steering wheel at the end of the parking manoeuvre → .
10. If necessary, carry out several parking manoeuvres.  
When the parking procedure is completed, a text message is displayed in the instrument cluster.
11. Parking the vehicle → page 190.

### WARNING

Fast steering wheel movements can cause serious injury.

- During the manoeuvring operation, do not grasp the steering wheel until prompted to do so by the system.
- If a dangerous situation occurs, take control of the steering.

## Driving out of a parking space

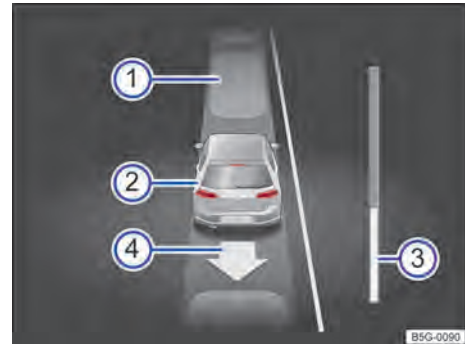

 Please refer to  and  on page 193 and  and  at the start of the chapter on page 201.



**Fig. 162** On the instrument cluster display: reversing out of a parallel parking space.

- ① Parked vehicle.
- ② Your vehicle.
- ③ Progress bar (remaining relative distance).
- ④ Direction of travel when driving out of a parking space

Park Assist can drive out of parallel parking spaces if the prerequisites for this are met → page 194.

1. Press the  button.
2. Use the turn signal lever to select the direction (left or right) in which you would like to drive out of the parking space.
3. Select reverse gear.
4. Release the steering wheel when the text message **Steering intervention active! Please monitor area around vehicle.** is displayed.
5. Accelerate carefully.
6. Brake when an acoustic signal sounds, the display  lights up, or until the prompt to drive forward appears on the instrument cluster display.
7. Continue the procedure for driving out of the parking space until a text message on the instrument cluster display and possibly an acoustic signal indicate that the procedure has been completed.
8. Depress the brake pedal until Park Assist has finished steering or until the  display on the instrument cluster goes out.
9. Take over steering with the steering angle set by Park Assist.

10. Drive the vehicle out of the parking space → ⚠.

### ⚠ WARNING

Drive the vehicle out of the parking space only when permitted by the traffic situation.

## Area View

### 📖 Introduction to the topic

Area View shows the entire vehicle surroundings in real time. This function can help you to detect obstacles at an early stage in confusing situations.

#### Function

The system uses several cameras to take images of the area around the vehicle which are then displayed on the Infotainment system screen → ⚠.

The Area View functions and displays may differ depending on the vehicle equipment, for example, if Park Distance Control is available and is also displayed.

### ⚠ WARNING

The intelligent technology used in the parking systems cannot overcome the laws of physics, and functions only within the system limits. If this is not observed, this can result in accidents, serious injuries and also damage to the vehicle.

- The parking system is not a substitute for the full concentration of the driver.

## Switching on and off

📖 Please refer to ⚠ and ⌚ on page 193 and ⚠ at the start of the chapter on page 204.



Fig. 163 In the centre console: button for switching Area View on and off.

#### Switching on

1. Select reverse gear.  
Or: press the  button → Fig. 163.

#### Switching off

1. Drive forwards faster than approximately 15 km/h (around 9 mph).  
Or: press the  button → Fig. 163.

#### Area View screen display

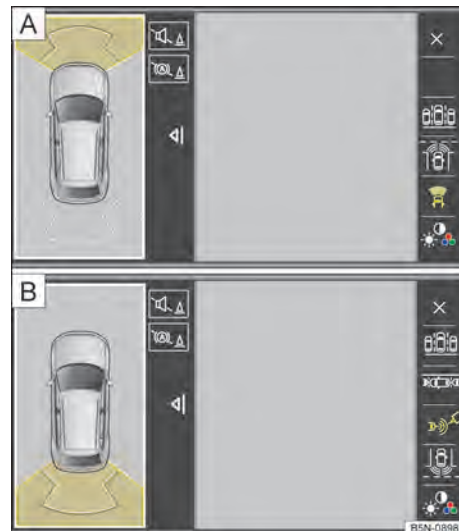

Fig. 164 Infotainment system: screen display of Area View.

- A Front camera.
- B Rear camera.

Area View is shown in two screen areas in the Infotainment system → Fig. 164:

**Left-hand area of the screen** A bird's eye view of the vehicle is shown. The view in the right area of the screen changes when you tap an individual area.

**Right-hand area of the screen** The individual camera images are displayed depending on the area selected on the left-hand screen.

Different function buttons are available at the edge of the display depending on the selected camera perspective → page 194, *Parking system displays in the Infotainment system*.

1. Tap the function button on the edge of the screen to select a corresponding display.

#### Area View – 3D view

A 3D view is available depending on the vehicle equipment.

1. Swipe the screen in the directions shown by the arrows to change the viewing angle in the 3D view.

## Trailer manoeuvring system (Trailer Assist)

### Introduction to the topic

The trailer manoeuvring system helps the driver when manoeuvring the vehicle backwards when towing a trailer.

The trailer manoeuvring system steers a trailer in the direction set by the driver with the rotary knob for adjusting the exterior mirror position. The driver operates the accelerator and the brake → . The trailer manoeuvring system determines the required data using the rear view camera system → page 197.

### WARNING

The intelligent technology used in the parking systems cannot overcome the laws of physics, and functions only within the system limits. If this is not observed, this can result in accidents, serious injuries and also damage to the vehicle.

- The parking system is not a substitute for the full concentration of the driver.

### WARNING

The trailer manoeuvring system does not use the area around the vehicle for orientation. No obstacle detection takes place. Drivers must judge for themselves whether the trailer can be manoeuvred safely.

- Always pay close attention to the movements of the trailer and break off the manoeuvre yourself if necessary to avoid causing any damage. On rare occasions the trailer may behave differently, even when Trailer Assist is operated correctly.
- Do not rely solely on the instrument cluster displays.



For technical reasons, the trailer manoeuvring system cannot always detect trailers with LED rear lights correctly.

### Prerequisites for the trailer manoeuvring system (Trailer Assist)

 Please refer to  and  on page 193 and  at the start of the chapter on page 205.

#### Synchronising the trailer

After each change of the vehicle and trailer, the trailer must be synchronised. In the process, the length of the drawbar is redetermined by the system:

1. Attach the one- or two-axle trailer and connect electrically to the vehicle.
2. Perform as many different turning and cornering manoeuvres with the trailer as possible.

The more accurately it can determine the length of the drawbar, the more angles are available when manoeuvring.

There is a maximum of four end stops for the angle display: around 30°, 45°, 60° and 75°.

#### Prerequisites

The following additional prerequisites must be met for the trailer manoeuvring system:

- ✓ The trailer with unsteered axles is correctly attached.
- ✓ The drawbar must not be covered.
- ✓ The vehicle and trailer are stationary.
- ✓ Driver door and boot lid are closed.

- ✓ The maximum vehicle and trailer angle (jack-knifing angle) is not exceeded.
- ✓ Exterior mirrors are not folded in.
- ✓ ESC is switched on.
- ✓ A driver interaction must take place within around three minutes, otherwise the manoeuvring procedure will be terminated and the Trailer Assist function ended.

- ④ Drive into the towing bracket.
- ⑤ Current position of the trailer (grey).
- ⑥ Target trailer position (orange).
- ⑦ Zero position on the angle display.

#### Switching on

1. Stop the vehicle.
2. Select reverse gear.
3. Press the **[Pw]** button.

#### Manoeuvring

1. Check the requirements before using the trailer manoeuvring system → page 205.
2. Release the steering wheel → **▲**.
3. Tilt the rotary knob until the desired direction is reached. A diagram showing the current position of the trailer appears on the instrument cluster display for orientation purposes → Fig. 166.
4. Slowly accelerate and reverse. Keep an eye on the area around the vehicle.
5. Correct the angle with the rotary knob if necessary → Fig. 165 ①.
6. Push the rotary knob to the left or right to select the direction of travel.
7. Pull the knob rearwards to drive in the direction of the trailer.
8. Drive forwards and backwards until the required position is reached.

The manoeuvring operation has been completed when a corresponding message is displayed on the instrument cluster. An acoustic signal may also sound.

#### **▲** WARNING

Fast steering wheel movements can cause serious injury.

- During the manoeuvring operation, do not grasp the steering wheel until prompted to do so by the system.
- If a dangerous situation occurs, intervene and take over steering yourself.

**i** The exterior mirrors cannot be adjusted while Trailer Assist is active → page 115.

**i** The vehicle cannot be driven at speeds above around 6 km/h (4 mph) while Trailer Assist is active.

## Manoeuvring the vehicle and trailer

**📖** Please refer to **▲** and **ⓘ** on page 193 and **▲** at the start of the chapter on page 205.

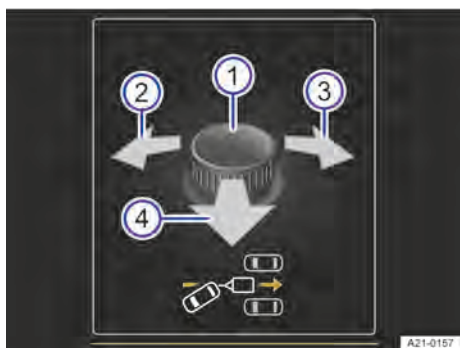

**Fig. 165** In the instrument cluster display: operating the rotary knob in the driver door.



**Fig. 166** In the instrument cluster display: adjusting the vehicle and trailer angle.

- ① Rotary knob for adjusting the exterior mirror position.
- ② Align the trailer to the left.
- ③ Align the trailer to the right.



## Rear Traffic Alert

Rear Traffic Alert monitors crossing traffic when reversing out of a parking space or manoeuvring.

### ⚠ WARNING

The intelligent technology used in the parking systems cannot overcome the laws of physics, and functions only within the system limits. If this is not observed, this can result in accidents, serious injuries and also damage to the vehicle.

- Pay attention to the traffic situation and the area around the vehicle.
- Rear Traffic Alert may not be able to detect all approaching objects, e.g. pedestrians or rapidly approaching objects.

### Switching on and off

1. Press the  button.  
**Or:** depending on the vehicle equipment, press the button for the driver assist systems.  
**Or:** depending on the vehicle equipment, open the vehicle settings in the Infotainment system → page 37.
2. Switches Rear Traffic Alert on and off.

 This setting can be saved in the user accounts of the personalisation function and can therefore change automatically when the user account is changed → page 41.

### Function



**Fig. 167** Illustration of Rear Traffic Alert: monitored area around the vehicle leaving the parking space.

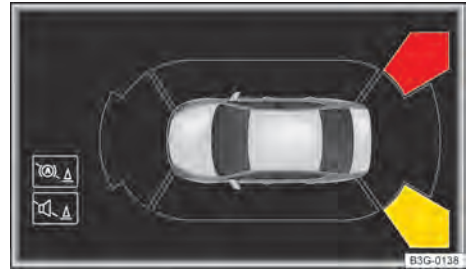

**Fig. 168** Infotainment system: Rear Traffic Alert display.

Rear Traffic Alert functions using radar sensors in the rear bumper.

The system detects approaching and moving objects in the rear and side areas around the vehicle → Fig. 167 and warns the driver about an obstacle → .

A warning signal sounds if an obstacle is detected. Depending on the vehicle equipment, the obstacle area is displayed in colour on the Infotainment system → Fig. 168 or a warning or indicator lamp lights up together with a text message on the instrument cluster.

An automatic braking intervention can take place if the driver does not react.



Obstacle detected. Pay attention to traffic behind the vehicle!



Automatic braking intervention of Rear Traffic Alert.

**Press the brake to keep the vehicle stationary.**



If Park Distance Control is deactivated, no feedback can be given to the driver. The Rear Traffic Alert is also temporarily deactivated.

### Things to note for trailer towing

The parking system cannot be activated if a trailer is electrically connected to the vehicle. 

## Brake support systems

### Information on brake support systems

These braking support systems can help the driver in critical driving or braking situations. The driver is responsible for driving safety → .

If a brake support system is performing a braking intervention, continue to brake with the necessary force, and if necessary steer the vehicle.

### **WARNING**

The intelligent technology used in brake support systems cannot overcome the laws of physics, and functions only within the limits of the system. Driving fast on icy, slippery or wet roads can lead to a loss of control of the vehicle and could cause serious injury to the driver and passengers.

- Ensure that your speed and driving style are always appropriate for the current visibility, weather and road/traffic conditions. Never take any safety risks.
- Brake support systems cannot prevent an accident if the vehicle is driven too close to the vehicle in front of it.
- Always use suitable tyres. Driving stability depends on the tyre grip.
- Always keep the footwell under the pedals clear so that the brake pedal can move freely.

– The ESC, ABS and TCS can only function properly if all four wheels are fitted with the correct tyres → .

– If the ABS fails, ESC, TCS and EDL will also cease to function.

The status of the brake functions is checked automatically when the ignition is switched on. The indicator lamps light up briefly and then go out again. If an indicator lamp remains lit up, there is a fault. Go to a suitably qualified workshop immediately. Volkswagen recommends using a Volkswagen dealership.

### **WARNING**

The effectiveness of ESC can be reduced considerably if other components and systems which affect driving dynamics are not serviced properly or are not functioning properly. This applies in particular to changes to the suspension and wheel and tyre combinations that have not been approved.

- Have vehicle conversions and modifications carried out only by a suitably qualified workshop. Volkswagen recommends using a Volkswagen dealership.
- Always use suitable tyres. Driving stability depends on the tyre grip.

### **Electronic Stability Control (ESC)**



ESC control intervention to reduce the risk of skidding and improve driving stability → . The indicator lamp flashes yellow.

### **Traction control system (TCS)**



TCS control intervention to prevent the wheels from spinning. The indicator lamp flashes yellow.

TCS reduces the drive output if wheelspin occurs and adapts the output to suit the road surface conditions. The TCS makes it easier to pull away, accelerate and drive up hills → .

### **Anti-lock brake system (ABS)**

ABS prevents the wheels from locking during braking so that the vehicle can still be steered → .

### **Brake Assist system**

BAS can help to reduce the stopping distance. The brake assist system reinforces the braking force when the driver depresses the brake pedal quickly in an emergency situation → .

### **Electronic differential lock (EDL and XDS)**

EDL brakes a spinning wheel automatically and distributes the drive force to the other drive wheels.

XDS uses braking interventions to improve traction and keep the vehicle in lane.

### **Automatic Post-Collision Braking System**

The multicollision brake automatically triggers braking if the airbag control unit detects a collision in an accident situation.

Requirements for automatic braking:

- ✓ The driver does not press the accelerator.

### **Brake servo**

The brake servo will only function when the engine is running and reinforces the pressure applied by the driver on the brake pedal.

If the brake servo is not functioning or the vehicle is being towed, the brake pedal will have to be depressed more forcefully as the braking distance will be increased due to the lack of assistance for the brake system → .

### **WARNING**

Driving without the brake servo or with restricted brake servo function can considerably increase the braking distance and cause accidents and serious injuries.

- Never switch the engine or ignition off while the vehicle is in motion.
- If the brake servo does not function or the vehicle is being towed, the brake pedal will have to be depressed more forcefully as the braking dis-

tance will be increased due to the lack of assistance for the brake system.

- Always keep the footwell under the pedals clear so that the brake pedal can move freely.

## Switching a brake support system off and on

### Driving situations

To prevent any safety risk, the braking systems should not be switched off under normal conditions → ⚠.

### ⚠ WARNING

With the ESC switched off, there is a much greater chance of the vehicle breaking away. It can be difficult for untrained drivers to retain control of the vehicle, especially at high speeds. This can result in accidents and severe injuries.

- Switch off the ESC only if you are driving on a closed road or track and have the necessary skills for sporty driving.
- Switch on the ESC Sport only if you are driving on a closed road or track and have the necessary skills for sporty driving.
- Never take a safety risk and make sure to observe the vehicle's specific physical limits.

### Switching on and off

1. Open the vehicle settings in the Infotainment system → page 37.
2. Open the settings for parking systems.
3. Select the function.

When the driving situation no longer exists, the brake system should be switched back on fully → ⚠.

### TCS

It can help to switch off TCS when driving on loose terrain or when rocking the vehicle backwards and forwards if it has become stuck → ⚠.



TCS Switched off manually. The indicator lamp lights up yellow.

### ESC Sport

This function supports a sporty driving style. The ESC intervenes later to stabilise the vehicle, for example when taking bends in the road at high speed → ⚠.



ESC Sport switched on. The indicator lamp lights up yellow.

### ESC off

This function supports a sporty driving style for experienced drivers. The ESC is switched off and no stabilising interventions take place. Always observe the safety warnings → ⚠.



ESC Switched off manually. The indicator lamp lights up yellow.



### Button in the centre console





**Fig. 169** In the centre console: button for switching TCS, ESC and ESC Sport on and off manually (with some equipment levels).

*R model:* In sporty special editions, the ESC settings can be changed using a button in the centre console → ⚠.

### Switching on ESC Sport

1. Press the  button for approximately 1 second → Fig. 169.  
TCS is switched off and ESC Sport is switched on.
2. Press the  button again to switch TCS back on.

### Switching off TCS and ESC

1. Press the  button for approximately 3 seconds → Fig. 169.  
TCS and ESC are switched off.
2. Press the  button again to switch on TCS and normal ESC again.

## Troubleshooting



### Anti-lock brake system failure or fault

The indicator lamp lights up yellow.

1. Go to a correspondingly qualified workshop. Volkswagen recommends using a Volkswagen dealership.

The vehicle can be braked without ABS.



### ESC fault

The indicator lamp lights up yellow. ESC has been switched off.

There is a fault or a malfunction.



1. Switch the ignition off and on.
2. Drive a short distance at a speed of approx. 15 km/h (around 9 mph) to 20 km/h (around 12 mph).
3. If the indicator lamp  remains lit, go to a correspondingly qualified workshop. Volkswagen recommends using a Volkswagen dealership.

### Noises of the brake support systems

The brake pedal may move or noises may occur while the brake support systems are performing a control intervention.

1. Continue to brake with the necessary force, and if necessary steer the vehicle.

#### WARNING

If the brake warning lamp  lights up together with the indicator lamp , the control function of the ABS may have failed. This can cause the rear wheels to lock relatively quickly when you brake. Locked rear wheels can lead to a loss of control of the vehicle.

- If possible, reduce the vehicle speed and drive carefully at low speed to the nearest suitably qualified workshop in order to have the brake system tested. Volkswagen recommends using a Volkswagen dealership.
- Avoid sudden braking and driving manoeuvres.
- The ABS is not functioning correctly if the indicator lamp  does not go out or comes on while the vehicle is in motion. The vehicle can be stopped using the normal brakes only (without the ABS). The protection provided by the ABS is then no longer available. Go to a correspondingly qualified workshop as soon as possible. Volkswagen recommends using a Volkswagen dealership.

## Practical equipment

### Stowage areas

#### Introduction to the topic

#### WARNING

Loose objects may be flung through the vehicle interior in the event of a sudden driving or braking manoeuvre. This can cause serious injury and can also lead to loss of control of the vehicle.

- Stow objects only in closed stowage compartments.
- Always keep stowage compartments closed while the vehicle is in motion.
- The coat hooks in the vehicle should only be used for lightweight clothing weighing max. 2.5 kg (approx. 5.5 lbs). Never leave any heavy, hard or sharp objects in the pockets.

#### WARNING

If the glove box is left open, this can increase the risk of serious injury in the event of an accident or during sudden braking or driving manoeuvres.

- Always keep the glove box closed while the vehicle is in motion.

#### WARNING

Any lighters in the vehicle could be damaged or accidentally lit. This could lead to serious burns and other injuries.

- Before closing stowage areas or compartments always make sure that there is no lighter in the way.
- Never stow lighters in stowage areas or compartments or on other surfaces in the vehicle. High surface temperatures, especially in summer, may cause lighters to self-ignite.

#### WARNING

Incorrect use of the drink holders can cause injury.

- Never place hot drinks in a drink holder. Hot drinks in a drink holder could be spilled and cause scalding in any sudden braking manoeuvre or accident.
- Make sure that only drinks of the appropriate size are placed in the drink holder. Drinks must always be stored securely in the drink holder.

### **⚠ WARNING**

Closed drink bottles can explode in the vehicle in extreme heat or burst in extremely cold temperatures.

- Never leave closed drink bottles in an extremely hot or extremely cold vehicle for extended periods.

### **ⓘ NOTICE**

- Do not stow any temperature-sensitive objects, food or medicines inside the vehicle. Hot and cold temperatures could damage them or render them unusable.
- Objects stored in the vehicle that are made from transparent materials, such as transparent suction cups on the windows, can concentrate the sun's rays and thus cause damage to the vehicle.

## **Drawers**

📖 Please refer to **⚠** and **ⓘ** at the start of the chapter on page 210.



**Fig. 170** Drawer under the front seat.

### **Opening the drawer**

1. Press the button in the drawer handle and open the drawer.

### **Closing the drawer**

1. Push the drawer under the front seat until it clicks into place.

### **⚠ WARNING**

An open drawer or objects that fall out in the driver's footwell can hinder the correct operation of the pedals. This can result in accidents and severe injuries.

- Always keep the drawers closed while the vehicle is in motion.

### **ⓘ NOTICE**

The drawer is designed for a maximum load of 1.5 kg (approx. 3.3 lbs).

## **Ashtray and cigarette lighter**



**Fig. 171** In the middle part of the centre console: cigarette lighter.

1. With the ignition switched on, press the knob on the cigarette lighter into the socket.  
The lighter knob will jump out when the wire spiral is hot enough.
2. Pull out the cigarette lighter → **⚠**.

### **⚠ WARNING**

Improper use of the cigarette lighter or ashtray could cause fires, burns and other serious injuries.

- Always use the cigarette lighter properly.
- Never leave children unsupervised in the vehicle. The cigarette lighter can be used when the ignition is switched on.
- Never put paper or any other combustible materials in the ashtray.



The cigarette lighter socket can also be used as a 12-volt socket.

## Sockets

### Introduction to the topic

Electrical equipment can be connected to the sockets in the vehicle.

The 12-volt socket will work only when the ignition is switched on.

#### **WARNING**

Improper use of the sockets and electrical accessories can cause fires and severe injuries.

- Never leave children unsupervised in the vehicle. Sockets and the devices connected to them can be used when the ignition is switched on.
- If the electrical device gets too hot, switch off the device immediately and disconnect it from the socket.

#### **NOTICE**

- In order to prevent damage to the electrical system, never connect equipment that supplies electric power, such as solar panels or battery chargers for charging the 12-volt battery, to the 12-volt socket.
- Use only electrical devices that have been approved in accordance with current guidelines concerning electromagnetic compatibility.
- Do not use faulty devices.
- In order to avoid damage due to voltage fluctuations, always switch off any electrical devices before switching the ignition on or off and before starting the engine.
- Never connect electrical devices requiring more than the rated power to a 12-volt socket. The vehicle's electrical system can be damaged if the maximum power output is exceeded.
- Observe the operating instructions of the electrical devices.

**i** Using electrical consumers with the engine switched off and the ignition switched on will drain the 12-volt battery.

**i** With some equipment levels, unshielded devices can cause interference with the Infotainment system and vehicle electronics. <

## Sockets in the vehicle

**📖** Please refer to **⚠** and **📌** at the start of the chapter on page 212.

The maximum power of the sockets must not be exceeded. The power consumption of the external devices is specified on their type plates.

### 12-volt socket



**Fig. 172** In the front stowage compartment, in the rear centre console or on the left-hand side of the luggage compartment: fold-open 12-volt socket (illustration).

The continuous power of all 12-volt sockets in the vehicle is 120 watts in total → page 212.

The maximum power of a 12-volt socket in the vehicle is a total of 180 watts when the engine is running.

#### **NOTICE**

The fuse can blow as a result of extended operation of the 12-volt sockets at maximum power.

- Never use the 12-volt sockets at maximum power for longer than 10 minutes.
- Always use only one 12-volt socket with maximum power.

### 230-volt socket, 115-volt socket, 100-volt socket



**Fig. 173** In the luggage compartment on the left side: 230-volt socket, 115-volt socket or 100-volt socket.

The maximum power is 150 watts (300 watts peak power).

The socket is activated automatically as soon as a plug is inserted when the engine is running. If there is sufficient energy in the system, the socket can also be used when the engine is off → ⚠.

#### Connecting an electrical device

1. In order to release the child socket protection, open the cover if necessary and plug the plug into the socket as far as it will go.

Electricity will not flow until the child socket protection has been unlocked.

#### LED display on the socket → Fig. 173.



LED lights up green: the childproof lock is unlocked. The socket is ready for use.



LED flashes green: the ignition is switched off but there is sufficient energy available to continue to supply the socket with power for up to 10 minutes. If the plug is removed during this time, the socket switches off and cannot be re-used until the ignition is switched on again.



LED flashes red: there is a malfunction such as a shutoff due to excess current or temperature.

#### Temperature switch-off

The inverter in the 230-, 115- or 100-volt socket will switch itself off automatically if the temperature exceeds a specific value. The switch-off function prevents the connected device from overheating when the power consumption is too high or if the ambient temperature is too high. The 230-, 115- or 100-volt

socket can be used again only after a cool-down phase.

The plug on the connected device must first be removed and then reinserted before using the 230-, 115- or 100-volt socket again after the cool-down phase. This prevents the electrical devices being switched on again unintentionally.

#### DANGER

High voltages in the electrical system can cause electric shocks, serious burns and death.

- Do not spill any liquids over the sockets.
- Do not plug any adapters or extension cables into the 230-, 115- or 100-volt socket. Otherwise the integrated child socket protection will be deactivated and power will be supplied to the socket.
- Do not insert any items which will conduct electricity, such as knitting needles, into the contacts of the 230-, 115- or 100-volt socket.

#### NOTICE

- Do not plug any very heavy devices or plugs, such as mains adapters, directly into the socket.
- Do not connect any lamps which use neon tubes.
- Only connect devices to the socket with a voltage that matches the voltage of the socket.
- In the case of electrical devices with a high starting current, the built-in excess current switch will prevent the device from being switched on. If this happens, disconnect the power supply from the electrical device and reconnect after waiting approximately 10 seconds.



Functional problems may occur with some devices when they are connected to the 230-, 115- or 100-volt socket due to the lower power output (wattage). ◀

# Data transfer

## Cybersecurity

Cybersecurity comprises measures to reduce the risk of unauthorised access by malware or an Internet attack on vehicle functions, data and control units.

### What are connectivity components?

Control units for data transmission, interfaces, and media and diagnostic connections are connectivity components, via which information and data can be exchanged between the vehicle and external devices or the Internet. The connectivity components that are not included in all vehicles are, in particular:

- Diagnostic port.
- Control unit with embedded eSIM card.
- Mobile phone interface.
- App-Connect.
- WLAN hotspot.
- NFC radio technology.
- Bluetooth interface.
- USB port.
- SD card slot.
- SIM card slot.

Connectivity components are the key elements for cyber security. Connectivity components are also equipped with security mechanisms that minimise the risk of unauthorised access to vehicle systems.

### Security mechanisms

The software and security mechanisms in the vehicle are subject to ongoing development. Like with computers or the operating systems of mobile telephones, the software and security mechanisms in the vehicle may also be updated at irregular intervals.

System updates improve the security, stability and running speeds of the vehicle systems in vehicles that have already been produced.

### WARNING

In spite of the integrated security mechanisms, malware can cause malfunctions in control units and vehicle functions. This can result in serious accidents and fatal injuries.

- Reduce speed in a controlled manner if the vehicle functions or reacts differently than usual.

- Please contact a suitably qualified workshop. Volkswagen recommends using a Volkswagen dealership.



Malware can also access data and information that are stored in control units, in the Infotainment system and on connected data media and paired mobile telephones.

### Minimising risks

You too can reduce the risk of unauthorised access to vehicle systems and functions:

- Use only data media, Bluetooth devices and mobile telephones in the vehicle than do not contain manipulated data or malware.
- Install system updates provided by Volkswagen immediately → page 214.
- Have the vehicle serviced, repaired and maintained only by a correspondingly qualified workshop. Volkswagen recommends using a Volkswagen dealership.

### WARNING

Computers, data media and mobile telephones that are connected to the internet or that are used in public and private networks may be infected by manipulated data or have malware installed on them.

- Protect computers, data media and mobile telephones by means of a suitable anti-virus program and generally known precautionary measures.
- Regularly update the appropriate anti-virus program with the system updates or upgrades from the provider.

## System update

### Introduction to system update

A system update is a preventive measure to optimise functionality and protect against malware, for example.

### What is a system update?

A system update allows the software of control units in the vehicle to be updated by Volkswagen without the need to visit a qualified workshop.

Every system update takes place in two phases: download and software installation. Before the start of each phase, the driver is requested on the Info-



tainment system to confirm the start of the respective operation.

The system update function is only available in some countries and not in all vehicles.

#### How can I see that a system update is available?

The switched-on Infotainment system indicates that a system update is available.

If several system updates are available for the vehicle at the same time, one system update must first be installed successfully before the next system update can be executed.

#### WARNING

It is possible in very rare cases that a control unit will not function properly after a software installation process.

- Do not use the vehicle. Contact Volkswagen Customer Care.

#### WARNING

If the digital instrument cluster does not function after software installation, no instruments, warning lamps, symbols or text messages can be displayed. Driving with an instrument cluster that is not working can cause accidents and fatal injuries.



- Do not use the vehicle. Contact Volkswagen Customer Care.

 A measure such as engine tuning to increase performance or efficiency that has not been performed by Volkswagen may be deleted by a system update.

 Depending on equipment, release notes may be displayed once before or after a system update which describe the changes to the vehicle status. The release notes cannot be viewed again after this.

 No In-Car App is updated with the system update.

### System update requirements

 Please refer to  at the start of the chapter on page 214.

The prerequisites must be met so that a system update can be downloaded and in order for you to install the software.



#### General conditions

- ✓ The system update function is offered in your country.
- ✓ You have assigned the vehicle to your active We Connect user account.
- ✓ Your current privacy settings allow data and information to be transmitted and received → page 221.

#### Vehicle conditions

- ✓ The vehicle is in an area with sufficient mobile reception.
- ✓ The electrical system in the vehicle is ready for use.
- ✓ The 12-volt vehicle battery is appropriately charged.

### Download and software installation

 Please refer to  at the start of the chapter on page 214.

#### Download costs

System updates are downloaded via the factory-fitted control unit with eSIM card and are free of charge. Volkswagen pays the connection costs.

#### Download

The following prerequisites must be met for download:

- ✓ Prerequisites for a system update → page 215.
- ✓ The ignition and the Infotainment system are switched on.
- ✓ Information on the Infotainment system has been observed.
- ✓ The download has been confirmed on the Infotainment system.

 The duration of a download process depends on the network quality, file size and type of system update. The download process can be interrupted at any time and will be resumed as required when the ignition is switched on.

#### Software installation

Choose a time for software installation when the vehicle does not have to be driven by yourself or other users.

Prerequisites:



- ✓ Prerequisites for a system update → page 215.
- ✓ The vehicle is parked safely in accordance with legal requirements and local conditions → page 190.
- ✓ Software installation has been confirmed in the Infotainment system.

### WARNING

Control units will be deactivated and will not function while software installation is taking place. Driving with deactivated or malfunctioning control units can cause accidents and fatal injuries.

- Carry out software installation so that other road users are not hindered.
- Never use your vehicle during a software installation procedure.



## Functional restrictions during software installation

 Please refer to  at the start of the chapter on page 214.

Control units, functions and displays are not available during software installation. Do not use the vehicle and do not operate the Infotainment system during this time.

- Central computer of the Infotainment system: during the software installation, the central computer, the display and control unit and other control devices are not available.
- Control unit of the digital instrument cluster: no or only few displays are possible on the digital instrument cluster during software installation.
- Control unit for We Connect: the services, Emergency Call Service and Automatic Accident Notification are not available during software installation.
- If the ignition is switched on during software installation, this can cause the following error message: **Error: emergency call. Please call workshop.** This is normal in this case. Please wait for a few minutes until the message disappears.



## After software installation

 Please refer to  at the start of the chapter on page 214.

After the software installation and before starting the engine, read the message in the Infotainment system or instrument cluster about completed installation. The vehicle requires up to one minute to display the status of the system update.

- The engine can be started after successful software installation.
- If software installation is unsuccessful: → page 216.

## Troubleshooting

 Please refer to  at the start of the chapter on page 214.

### Software installation was unsuccessful

- If software installation is unsuccessful, a corresponding error message will be displayed on the Infotainment system or instrument cluster. Observe the corresponding messages and warnings.
- Control units will no longer function or will not function correctly in the event of a critical installation error. Functions and displays are not available until the error is corrected. Do not use the vehicle. In this case, contact Volkswagen Customer Care.

### Should I perform the system update?

It is in your own interests to carry out system updates promptly. If the driver repeatedly rejects the system update, it is then necessary to visit a correspondingly qualified workshop. Volkswagen recommends using a Volkswagen dealership.

### Can I interrupt software installation?

No, this is not possible.

### What will happen if software installation is interrupted?

If software installation is interrupted, for example due to damage to the electrical system in the vehicle, it is possible that control units will be not be updated and may be damaged due to incomplete software installation.

# We Connect

## Introduction to the topic

To use We Connect, it must first be activated online by concluding a We Connect contract with Volkswagen and is subject to a restricted, country-dependent period of validity.

Both the We Connect portfolios offered by Volkswagen and individual services may be changed, discontinued, deactivated, reactivated, renamed and expanded without further notice.

For more information about creating the user account, the service description, and further information, see [www.connect.volkswagen-we.com](http://www.connect.volkswagen-we.com). The provision and availability of We Connect services and service portfolios can vary from country to country and depend on the vehicle and vehicle equipment.

### Service description

Read and observe the service description before using We Connect services. Service descriptions are updated from time to time and made available online at [www.connect.volkswagen-we.com](http://www.connect.volkswagen-we.com).

1. Always use the latest edition of the relevant service description.

### WARNING

In areas with insufficient mobile phone and GPS reception, no emergency calls and phone calls can be made and no data can be transmitted.

- Move to a different location.

### NOTICE

Vehicle damage may be caused by factors beyond the control of Volkswagen. Such factors include in particular:

- Insufficient network strength.
- Misuse of mobile devices.
- Data loss during transmission.
- Unsuitable and faulty third-party apps.
- Malware on data media, computers, tablets and mobile telephones.

## Service portfolio

The initial assignment of services listed here represents the maximum possible scope. The maximum possible scope is available only for a few vehicle

models. There may be changes in the assignment shown here during the service life of the vehicle.

After activating the "Manage services" function, you can see whether and which services are available in the vehicle in the Infotainment system → page 220.

The portfolio of offered services may be different than that specified here in some countries and in the event of contract renewal.

The voice or search recognition technology for We Connect does not recognise and return search results for all words. For example, Google Speech Recognition includes a "Safe Search" feature that prevents the display of search results if vulgar terms are accidentally detected.

 You can find out which services actually belong to We Connect, We Connect Plus and We Connect Fleet when you conclude or renew your contract for the portfolio at [www.connect.volkswagen-we.com](http://www.connect.volkswagen-we.com) or on the Volkswagen website. This also applies to possible We Connect individual options.

### We Connect services and functions available without activation

The following services also function without We Connect activation:

- Emergency Call Service.
- Personalisation online.
- In-Car Apps in the In-Car Shop.

 The Emergency Call Service is available independently of logging into the Infotainment system. Personalisation and purchase of In-Car Apps require you to log into the Infotainment system, but do not need activation of the vehicle in a We Connect user account.

### We Connect services

*Maximum possible scope. Not available in all vehicles and countries.*

- Driving data.
- Vehicle status.
- Vehicle Health Report.
- Information Call.
- Mobile key.
- Emergency Call Service.
- Breakdown Call.
- Parking Position.
- Service Scheduling.
- Doors & Lights.

- Wi-Fi hotspot.

### We Connect Plus services

*Maximum possible scope. Not available in all vehicles and countries.*

- All We Connect services.
- Departure times
- Charging.
- Air Conditioning.
- Apple Music®.
- TIDAL.
- Horn & Turn Signals.
- Charging Stations.
- Online Anti-Theft Alarm.
- Online Map Update.
- Online Route Calculation.
- Online Voice Control.
- Online Auxiliary Heater and Ventilation.
- Online Traffic Information.
- Parking Spaces.
- Filling Stations.
- Lock & Unlock.
- Internet Radio.
- Remote Ventilation Control.

### We Connect Fleet services

*These services are available only for commercial customers and fleet operators.*

Additionally to the We Connect services:

- Digital Logbook.
- Fuel Logbook.
- Fleet Driving Efficiency.
- GPS Tracking & Route Information.
- Consumption Analyser.
- Maintenance Management.

### We Connect individual options

- In-Car Apps. These apps may be pre-installed directly in the Infotainment system and activated by the user. If technically implemented, apps can also be purchased and installed in the Infotainment system via the In-Car Shop.
  - Digital owner's manual (User Guide).
  - We Experience.
  - App-Connect.

- Data plans. Data plans subject to payment of a fee for use of online functions, e.g. 2 GB per month.
- Subsequent purchase of additional mobile keys. <

## Activating We Connect, S-PIN, vTAN procedure

### Activating We Connect

Take the following steps to activate and register We Connect:

1. Create a user account in the user area of the website [www.myvolkswagen.net](http://www.myvolkswagen.net) or directly in the Infotainment system in the **Manage users** menu.
2. Order and activate We Connect.
3. Add a vehicle to your user account.
4. Provide proof of ownership.
5. Provide proof of identity. This is only necessary if security-related We Connect services are to be carried out.

You can perform activation at [www.connect.volkswagen-we.com](http://www.connect.volkswagen-we.com) or directly in the Infotainment system. Proceed as follows for activation via the Infotainment system:

1. Tap **(HOME)** ► **(Manage users)** ► **Become primary user**.  
Or: tap **(MENU)** ► **(Manage users)** ► **Become primary user**.

Follow the other information and instructions in the Infotainment system. During activation, you may be requested to create an S-PIN → page 218.

### Activation options

10", 9.2" and 8" Infotainment system	Yes
8.25" Infotainment system	not possible
6.5" Infotainment system	not possible
myVolkswagen	Yes
We Connect app	Yes

### S-PIN

The S-PIN is a multi-digit number sequence that can be freely selected during the We Connect registration process.

When creating the S-PIN, avoid easy-to-guess number sequences and generally known birthday dates. The S-PIN can be changed in the We Connect user account under "Account settings".

The S-PIN is required, for example, to protect your user profile or to execute a security-related We Connect service in the vehicle.

You must treat the S-PIN as strictly confidential. For security reasons, you should change the S-PIN if the S-PIN is disclosed to a third party.

### vTAN procedure

If, for example, a mobile key is downloaded and installed for the first time on the main user telephone from the user area of [www.myVolkswagen.net](http://www.myVolkswagen.net), the vTAN procedure must be performed:

1. In the vehicle, switch on the ignition and, if applicable, the Infotainment system.
2. Follow the instructions in the We Connect app and the Infotainment system.
3. Enter the vTAN from the app in the Infotainment system and confirm.

The vTAN procedure has been completed.

If the vTAN message windows are not displayed automatically, manually request a vTAN under **Mobile key** or **User**.

## Proof of ownership and identity

### Becoming the primary user (proof of ownership)

(2-key method).

In order to become the primary user and thus provide proof of ownership of the vehicle, you need the two mechanical vehicle keys that belong to the vehicle. Proof of ownership is provided in the vehicle during registration or, if a We Connect user account already exists, in the Infotainment system via the **Manage users** function.

1. Switch on the ignition and the Infotainment system.
2. In the Infotainment system, register for We Connect.

**Or:** in the menu **Manage users** ► **Settings** ►, tap **Become primary user** and follow the instructions.

3. Press the open button on the first vehicle key.
4. Press the open button on the second vehicle key.

Once the Infotainment system has processed the radio commands, proof of ownership is verified.

You can check the current status in the user area of the website [www.myvolkswagen.net](http://www.myvolkswagen.net).

### How is proof of ownership provided?

10", 9.2" and 8" Infotainment system	2-key method
--------------------------------------	--------------

### How is proof of ownership provided?

8.25" Infotainment system	2-key method
6.5" Infotainment system	Transmission of the registration codes from the We Connect portal or We Connect app to the Infotainment system.
<a href="http://www.myvolkswagen.net">www.myvolkswagen.net</a>	<i>not possible</i>
We Connect app	<i>not possible</i>

 Proof of ownership in the vehicle can be provided by the "2-key method" or by transferring the registration codes from [www.myvolkswagen.net](http://www.myvolkswagen.net) or the We Connect app into the Infotainment system.

### Proof of identity (Volkswagen Ident)

The proof of identity must be provided before security-relevant We Connect services such as "Lock & Unlock" can be used. Proof of identity can be provided in two ways:

- Personally, at your Volkswagen dealership.
- Via video chat together with identity documents in the We Connect app.

Further information on Volkswagen Ident is available in the user area of the website [www.myvolkswagen.net](http://www.myvolkswagen.net).

 Costs may be incurred due to data exchange during the video chat. The extent of these costs depends on tariffs and contracts that you concluded with third-party providers, e.g. telephone or mobile phone providers.

## Legal requirements

When using the We Connect services, information about the vehicle is transmitted and processed online. This data can also indirectly provide information about the respective driver, e.g. driving behaviour. As the contracting party of the We Connect contract with Volkswagen, you must ensure that data protection and privacy rights are guaranteed when your vehicle is used by family members, friends and other drivers. You must inform the respective driver in advance that the vehicle is transmitting and receiving data online and that you can view this data.

Failure to observe this obligation to inform can infringe certain rights of vehicle occupants.

### Tracking services: ask all vehicle occupants

Tracking services require geodata and vehicle data to determine whether the vehicle is complying with

set speed limits, where the vehicle is parked, or whether the vehicle is being used in a geographically-defined area. This information is displayed in the user area of the website [www.myvolkswagen.net](http://www.myvolkswagen.net) and in the We Connect app.

Therefore, before driving, ask all occupants if they agree to use of the activated services. If an occupant does not agree, deactivate the services if possible or exclude the occupant from use of the vehicle.

### Personal data

Volkswagen protects your personal data and uses it only to the extent permitted by law, or if you have consented to its use. Further information on data processing in relation to the We Connect services can be found in the Privacy Policy. The current version of this policy can be accessed on the Volkswagen website.

### Permanent transfer of the vehicle

If the vehicle has been purchased as a used vehicle or handed over to you by another person for permanent use, We Connect may already be activated and the previous user may still have the possibility to view collected data and control certain vehicle functions via We Connect.

In the Infotainment system you can see whether a person is assigned to your vehicle as the primary user. In this case, you can register yourself as the primary user of the vehicle and automatically remove the previous primary user.

Alternatively, you can permanently delete the previous user as the primary user in the Infotainment system. You can also set the vehicle to offline mode (→ page 221) here and thus restrict communication of your vehicle with the data server of Volkswagen and processing of vehicle-related and personal data. <

## Deactivating We Connect services

The following functions are available for deactivating and activating the We Connect services:

- Central deactivation and activation via the Infotainment system → page 221, *Privacy settings*.
- Individual deactivation and activation via your user area of the website [www.myvolkswagen.net](http://www.myvolkswagen.net) or in the We Connect app.

The respective services can only be run again after the deactivation is cancelled.

Some streaming services can be activated or deactivated only together, even if they are listed separately in the individual menu.

 Legally required services and their data transmissions cannot be switched off and cannot be deactivated, e.g. "eCall Emergency System". <

## Interference

Even when the above-mentioned requirements for using the services are met, the functionality of the We Connect services can be impaired or interrupted due to factors that are beyond the control of Volkswagen. Such factors include in particular:

- Maintenance, repairs, deactivations, software updates and technical changes to your service provider's telecommunication systems, satellites, servers and databases.
- The telecommunications provider has changed the mobile telecommunication standard for transferring mobile data, e.g. from LTE or UMTS to EDGE or GPRS.
- An existing mobile telecommunications standard has been shut down by the telecommunications provider.
- Disturbance, interference or interruption of mobile and GPS reception, e.g. due to high speeds, weather, landscape, interfering devices or intensive use of the mobile network in the relevant cells.
- If your current location is in an area with no or insufficient mobile communications and GPS reception. This can also include tunnels, streets with tall buildings, garages, multi-storey car parks, underpasses, mountains and valleys.
- Restricted availability, completeness or correctness of information provided by third parties, e.g. maps.
- Countries and regions where We Connect services are not available. <

## Manage services

Open the function for managing services: tap **System** ► **Service**.

The following are possible in the Manage services area of the Infotainment system:

- Checking which We Connect services are currently available in the vehicle.
- Number of activated and deactivated We Connect services.
- Activating or deactivating individual We Connect services.

Further information: [www.connect.volkswagen-we.com](http://www.connect.volkswagen-we.com).

 If you deactivate all We Connect services individually, the control unit with embedded eSIM card can still transmit data.

### Settings

We Connect services can be activated or deactivated individually. To do this, open the drop-down list for the service and make the corresponding selection.

If data transmission is restricted by the "privacy settings" function, it is not possible to activate or deactivate services individually.

#### Function button and its function:

**Manage services**

**Display services**

All: overview of services available in the vehicle.

Activate: activate one or more services.

Deactivate: deactivate one or more services.

The setting options are not available in all countries and vehicle models.

## Privacy settings

### Introduction to the topic

The "privacy" function enables the staggered blocking or authorisation of data transmission between the vehicle and the internet.

The required mode can be set in the Infotainment system.

The "Privacy settings" function applies only to data transmissions via the control unit with embedded eSIM card. The "Privacy settings" function cannot prevent the transmission of data from a mobile telephone that is paired with the mobile phone interface.

The "Privacy settings" function is not available with all Infotainment systems.

Legally required services and their data transmissions cannot be switched off and cannot be deactivated, e.g. "eCall Emergency System".

 Please note that every vehicle user can adjust individual settings in the "Privacy settings" function. These settings may be different from those preferred by the vehicle owner.

## Privacy settings

In order to permit or prevent data transmission, activate one of the four following modes on the Infotainment system.

### Mode: Offline

The following happens in this mode:

- All We Connect, We Connect Plus and We Connect Fleet services are deactivated and do not transmit any data.
- All tracking services are deactivated → page 222.
- The eSIM card is deactivated.
- All vehicle functions that require an online connection via the eSIM card are deactivated → page 222.
- It is not possible to update any information and data stored in the control units, e.g. emergency call numbers. This can restrict functions and services or mean that they are not available.
- Legally required services cannot be deactivated and still transmit data.

### Mode: No position data

The following happens in this mode:

- The current position of the vehicle is not transmitted.
- All tracking services are deactivated → page 222.
- The eSIM card remains activated.
- All vehicle functions that require an online connection via the eSIM card are activated → page 222.

### Mode: Use my position

The following happens in this mode:

- Information on the current position of the vehicle is not provided to other persons.
- All tracking services are deactivated → page 222.
- The eSIM card remains activated.
- All vehicle functions that require an online connection via the eSIM card are activated.

### Mode: Share my position

The following happens in this mode:

- All We Connect, We Connect Plus and We Connect Fleet services can transmit and receive data without restriction.
  - All tracking services are activated.
  - Primary and secondary users can access the vehicle's position data via the We Connect app.
- The eSIM card is activated.
  - All vehicle functions that require an online connection via the eSIM card are activated. <

## Status display

The following symbols display the status of the privacy function individually or together in the Infotainment system.



grey bullet point (offline): no connection to the Internet.



white bullet point (online): connection to the Internet.



Symbol for "Offline" mode.



Flag for no location mode.



Flag for use location mode.



Flag for share location mode.

Display example for "Offline" mode: <

## Effects on online functions and tracking services

If data transfer is restricted, the following online functions and tracking services cannot be executed, for example.

Some online vehicle functions and tracking services are available only in certain countries and vehicle models.

### Online vehicle functions

- Emergency Call Service.
- Online Anti-Theft Alarm.
- Online Voice Control.
- Online Map Update.

- Online Traffic Information.
- Personalisation.
- System update.
- We Connect registration and activation.

### Tracking services

- Vehicle tracking.
- Area Alert.
- Speed Alert.
- Parking Position.



The restrictions also apply to new online vehicle functions and tracking services that are provided for the vehicle in future. <

## User administration

### Description of user roles

Open user management: tap the menu **Users** or **Manage users** on the start page of the Infotainment system.

#### Primary user or

The "primary user" role is intended for the vehicle keeper or a vehicle user with only temporary authorisation to use the vehicle such as a lessee or company car driver. The primary user has unrestricted rights and can assign additional rights to other users of the vehicle by inviting them as secondary users.

If a new primary user legitimises themselves for the vehicle, the previous primary user will automatically lose their primary user role. <

#### Secondary users or

The "Secondary user" user role is intended for users who also use the vehicle regularly. Secondary users derive their role from the primary user and must be invited for the vehicle by the primary user. The primary user can delete secondary users at any time.

#### Guest users

The "Guest user" user role is intended for users who use a vehicle occasionally or only once. Guest users can log in themselves in every vehicle with service capability and involvement of the primary user is not necessary. Every vehicle user can delete the guest user in the vehicle at any time. The guest user has only restricted access to certain online services.



## Anonymous guest

The "Anonymous guest" user role is a non person-specific account that exists locally in the vehicle and cannot be synchronised with the server. This account exists only once in vehicles with online personalisation and cannot be deleted.

If the "Anonymous guest" role is activated in the vehicle, all users logged into the vehicle will be logged out temporarily.

Anonymous users are persons who have access to the vehicle but do not log in.

## Creating and deleting user roles

### Creating a primary user

Register with We Connect and add your vehicle to your user account.

### Creating secondary users

New users can log in with your We Connect user account or register as new users in the vehicle. A user profile is automatically created in the Infotainment system.

If a new user was not invited as a secondary user by the primary user, the user profiles will be automatically stored as a guest user in the Infotainment system.

### Deleting the primary user

1. Set privacy settings to "Share my position" mode or "Online mode".
2. Restore the factory settings of the Infotainment system.

**Or:** legitimise a new user in the vehicle.

 If a different privacy setting is chosen, the primary user may still be present on the server. <

## Settings

Access settings in the Infotainment system:

1. Tap **HOME** ► **Manage users**.  
**Or:** tap **MENU** ► **Manage users**.

These setting options may be available, depending on the vehicle equipment:

- Me (primary user).
- Others (secondary users).
- Key.
- Settings. <

## We Upgrade

### Introduction to the topic

With We Upgrade, the vehicle can be extended by new functions after delivery.

### Functions

- < Depending on the vehicle model, you can activate comfort and Infotainment system functions, along with driver assistance systems.

Activation of We Upgrade functions depends on the country and vehicle.

 If the required hardware for the respective activable function is not available in the vehicle, it can be retrofitted in some cases by a correspondingly qualified workshop. Volkswagen recommends using a Volkswagen dealership.

 If the required software for the respective activable function is not available in the vehicle, it can be retrofitted → page 214. Retrofitting may be subject to charge, depending on the type of software.



Inform the user or buyer about unlocked functions when renting or selling the vehicle.

### WARNING

If the driver is distracted when driving, this can cause accidents and serious injuries.

- Only activate functions when the vehicle is stationary. <

## Viewing and activating functions

 Please refer to  at the start of the chapter on page 223.



### Viewing functions

The activated We - Upgrade functions for the vehicle are displayed in the In-Car - Shop of the Infotainment system.

Prerequisites:

- ✓ The vehicle is assigned to a We Connect user account.
- ✓ The electrical system in the vehicle is ready for use.

- ✓ The 12-volt vehicle battery is appropriately charged.

1. Tap **HOME** ►  ► .
2. Open the **Privacy settings/services** menu.
3. View functions.

### Activating functions



The We Connect primary user can activate the existing We Upgrade functions for the vehicle in the In-Car Shop of the Infotainment system or in the We Connect web shop.

#### Prerequisites:

- ✓ You are the We Connect primary user for the vehicle.
- ✓ You have a valid We Connect contract with Volkswagen.
- ✓ The vehicle is assigned to your We Connect user account.
- ✓ Sufficient mobile reception is available at the current location of the vehicle.
- ✓ The electrical system in the vehicle is ready for use.
- ✓ The 12-volt vehicle battery is appropriately charged.
- ✓ Tethering via mobile telephone or eSIM is available.

1. Tap **HOME** ►  ► .
2. Open the **Privacy settings/services** menu.
3. Activate functions in the In-Car Shop.

## Troubleshooting

 Please refer to  at the start of the chapter on page 223.

### Where can I obtain functions?

Functions are available from an online shop accessible via your We Connect user account.

Depending on the vehicle equipment, functions can also be activated directly via the Infotainment system in the In-Car shop.

### Function restrictions during activation

The function is not available during activation.

### After successful activation

Successful activation is displayed in the Infotainment system.

### When will the activated function be available?

Depending on the activated function, it is either available immediately or after switching the ignition back on. 

## Wi-Fi hotspot

### Introduction to the topic



The WLAN hotspot function is not available in all markets and vehicles.

Some Infotainment systems can be used as a WLAN hotspot to provide Internet access for up to eight WLAN devices.



Some Infotainment systems can use the WLAN hotspot of an external WLAN device (WLAN client) → page 226.

A data connection is required to set up a connection to the internet and to use services such as We Connect.

 As default, the WLAN connection is encrypted using WPA2 encryption for security reasons. Volkswagen recommends always using WPA2 encryption. Observe country-specific requirements.

 The necessary data transfer may be subject to charges. Due to the potentially high volume of data in use, Volkswagen recommends using a mobile device tariff which includes a data flat rate. For more information contact your mobile telephone provider. 

 Depending on your mobile telephone tariff, additional costs such as roaming charges may be charged for loading and using online data packages, especially if you use these services abroad.

 When you cross the border into countries that have different permitted radio frequencies than in your own country, operation of the wireless function/Wi-Fi must be deactivated due to legal requirements. Operation of functions that are connected by cable is not affected by this restriction, and these functions can still be used. 

### Setting up a data connection

#### Wi-Fi (9.2" version and 8" version)

- WLAN in accordance with IEEE 802.11 a/b/g/n/ac.
- Transfer in 2.4 GHz and 5 GHz (country-dependent).

- Two WLAN modes simultaneously:
  - Tethering (2.4 GHz and 5 GHz).
  - 2.4 GHz and 5 GHz access point.
- Up to eight WLAN devices can be connected simultaneously.
- Internet connection via WLAN:
  - Tethering via mobile telephone.
  - Hotspot for clients in the vehicle.
- Apple CarPlay™ via WLAN.
- Android Auto™ via WLAN.
- Simplified pairing process via WPS, NFC or QR code.

### Possible types of data connections

**eSIM (embedded SIM):** The vehicle has a control unit with embedded eSIM card (eSIM). To use the Wi-Fi hotspot, you need to purchase data plans via the In-Car Shop or our mobile telephone partner's web shop.

**External Wi-Fi device:** Use the WLAN hotspot of an external mobile telephone → page 226.

The available data connection types depend on the country and the vehicle equipment level.

## Setting up and deactivating a Wi-Fi hotspot

The Infotainment system can be used as a WLAN hotspot to provide online access for up to eight WLAN devices.

In order to establish a connection to the internet and be able to use services such as We Connect, a data connection is additionally required, for example by using an internal eSIM card or an external WLAN device. The types of data connections possible depend on the country and the Infotainment system used.

### Setting up the Wi-Fi connection

1. Tap **[MENU]**  **[Wi-Fi]** **[Infotainment system as hotspot]**.
2. Activate the  **Mobile hotspot** checkbox.
3. Search for the displayed name of the WLAN device.
4. Enter the displayed network key on the WLAN device and confirm.

The WLAN connection is set up. Further inputs may be required on the WLAN device to complete the connection.

5. Repeat the procedure to connect further WLAN devices.

 The name of the hotspot and the network key are automatically generated. You can then define a name for the hotspot and the network key yourself.

### Deactivating the Wi-Fi hotspot

1. Open the **Hotspot (Wi-Fi) settings** menu. To do this, tap **[MENU]**  **[Wi-Fi]** **[Infotainment system as Hotspot]**.
2. Deactivate the  **Mobile hotspot** checkbox.  
The Wi-Fi hotspot is deactivated. <

## Quick connection

The quick connection function makes it possible to easily and quickly establish a wireless local network with encryption. Alternatively, in some countries the function can be performed using a scanning a code.

### WPS with Infotainment system as Wi-Fi hotspot

Prerequisites:

- ✓ The WLAN hotspot of the Infotainment system is activated.
- ✓ The WLAN device supports WPS.

1. Tap **[MENU]**  **[Wi-Fi]**.
2. Tap **[Quick connection with Infotainment system]**.
3. Activate WPS on the WLAN device that is to be connected.

The WLAN connection is set up. Further inputs may be required on the WLAN device to complete the connection.

4. Repeat the procedure to connect further WLAN devices.

It is possible to establish only one WPS connection at a time. If several connection attempts are started simultaneously, all connection attempts will fail.

### WPS with Infotainment system as client

Prerequisites:

- ✓ The WLAN hotspot of the Infotainment system must be deactivated.
- ✓ The WLAN device must support WPS.

1. Tap **[MENU]**  **[Wi-Fi]** **[Wi-Fi]**.
2. Tap **[WPS quick connection (WPS button)]**.
3. Activate WPS on the external WLAN device.

The WLAN connection is set up. Further inputs may be required on the WLAN device to complete the connection.

 WPS is not supported by all WLAN devices. Establish the connection manually in this case:

- Set up the Infotainment system as a WLAN hotspot → page 224, → page 225.
- Connect the Infotainment system as a client to the hotspot of an external WLAN device → page 226.

### Carrying out Wi-Fi pairing via NFC

WLAN pairing can be carried out via NFC using the stowage area of the wireless charging function.

Prerequisites:

- ✓ The stowage area of the wireless charging function is installed in the vehicle.
- ✓ NFC is activated in the WLAN device.
- ✓ The WLAN hotspot of the Infotainment system is activated.

1. Tap **MENU** ►  ► **Wi-Fi**.
2. Tap **Quick connection with Infotainment system**.
3. Unlock the WLAN device and place it on the stowage area of the wireless charging function → page 260.

The WLAN device is connected as a client to the WLAN hotspot of the Infotainment system.

 While the Infotainment system is in the WLAN settings menu, the wireless charging function is deactivated. Wireless charging is reactivated when you exit the settings menu.

 In the case of older WLAN devices, the function may be restricted or may not work. Make sure you are using the latest software version for your WLAN device.

### Wi-Fi pairing via QR code

The WLAN connection can also be established by scanning the corresponding QR code.

Prerequisites:

- ✓ The WLAN hotspot of the Infotainment system is activated.
- ✓ A suitable application for scanning QR codes is installed on the WLAN device.

1. Tap **MENU** ►  ► **Wi-Fi**.
2. Tap **Quick connection with Infotainment system**.
3. Scan the QR code on the Infotainment system screen with the Wi-Fi device.

The WLAN device is connected as a client to the WLAN hotspot of the Infotainment system. <

## Configuring a Wi-Fi client

The Infotainment system can use the Wi-Fi hotspot of an external Wi-Fi device, such as a mobile telephone, to establish an internet connection to use online services.

### Setting up the Wi-Fi connection

1. Activate the Wi-Fi hotspot on the Wi-Fi device; refer to the manufacturer's operating instructions.
2. Open the **Wi-Fi hotspots** menu. To do this, tap **MENU** ► **Setup** ► **Wi-Fi** ► **Wi-Fi**.
3. Activate Wi-Fi on the Infotainment system. For this, activate the  **Wi-Fi** checkbox.
4. Tap **Find** and select the required Wi-Fi hotspot from the list. The search process for available Wi-Fi hotspots may take a few seconds.
5. If necessary, enter the Wi-Fi hotspot network key on the Infotainment system and confirm with **OK**.

The Wi-Fi connection is set up. Further inputs may be required on the Wi-Fi device to complete the connection.

**Manual settings**: enter the network settings of an external Wi-Fi device manually.

 The Infotainment system cannot be used simultaneously as a hotspot and as a client of a Wi-Fi network. To connect the Infotainment system as a client with a Wi-Fi device, the hotspot of the Infotainment system must first be switched off.

 Due to the large number of possible Wi-Fi devices, it is not possible to guarantee fault-free operation of all functions.

 The availability of the Wi-Fi function is country-specific and may vary. <

## Adjusting settings

### Accessing Wi-Fi settings

1. Tap **HOME** ► **SETTINGS** ► **Wi-Fi**.

The following settings are possible:

- Set up the Infotainment system as a hotspot.
- Connect to the Infotainment system via a fast connection.

— Connect to the WLAN.

1. Make corresponding entries or tap function buttons.

Changes are automatically stored when a menu is closed.

## App-Connect

### Introduction to the topic

App-Connect enables the user to display and operate content and functions from the mobile telephone on the Infotainment system screen.

For this, the mobile telephone must be connected to the Infotainment system using a USB interface with data transfer function.

Some technologies can also be accessed using App-Connect Wireless via the Bluetooth interface and a WLAN connection.

#### The following technologies may be available:

- Apple CarPlay™.
- Apple CarPlay™ Wireless.
- Android Auto™.
- Android Auto™ Wireless.
- MirrorLink®.

The availability of the App-Connect technologies is country-dependent and may vary according to the mobile telephone.

MirrorLink, Apple CarPlay and Android Auto are technologies that are operated by third parties and made available by Volkswagen. Volkswagen is not responsible if these technologies are terminated, discontinued or deactivated during the service life of the vehicle.

For more information, please visit the Volkswagen website.

#### Wireless function of App-Connect after crossing a border

Please note the following if you cross borders into countries that have other permitted radio frequencies than in your own country:

- The wireless function of App-Connect is restricted or is not possible at all due to legal requirements. This may be indicated by a message displayed on the Infotainment system.
- The wireless function of App-Connect must be deactivated due to legal requirements. The Wi-Fi hotspot must be deactivated.

This does not apply to the function connected by cable.

#### Opening the App-Connect main menu

The navigation to the App-Connect main menu depends on the Infotainment system used.

1. Tap **HOME** .
- Or: press **APP**.

#### Setting up App-Connect Wireless

You must first pair the mobile telephone with the Infotainment system to use App-Connect Wireless. Proceed as follows:

#### Connecting the mobile telephone for the first time

1. Unlock the mobile telephone.
2. Activate WLAN reception and Bluetooth on the mobile telephone.
3. Connect the mobile telephone to the Infotainment system using a USB cable or Bluetooth.
4. Open the App-Connect main menu if it does not load automatically.
5. Select the mobile telephone and the required technology.
6. Grant the Infotainment system the necessary permissions. To do this, confirm the permission requests on the mobile telephone.
7. Disconnect the USB connection and connect to the Infotainment system again using WLAN or Bluetooth.

App-Connect Wireless is now set up.

Pairing is complete. In future, the connected mobile telephone will also be able to use App-Connect Wireless without a USB connection.

App-Connect Wireless will not be available if you do not confirm the pop-up menus during the connection process. In this case, Volkswagen recommends deleting the mobile telephones in both the device settings and on the Infotainment system and re-starting the connection process.

 Wireless App-Connect may not be supported by all technologies.

#### WARNING

Using apps while the vehicle is in motion can distract you from the road. Accidents and injuries can occur if the driver is distracted.

- Drive with your full attention and with responsibility.
- Use apps and functions only when the vehicle is stationary.

## WARNING



Use of unsuitable apps or incorrect use of apps can cause damage to the vehicle, accidents or serious injury.

- Protect the mobile telephone with its apps against misuse.

## NOTICE

Volkswagen is not responsible for damage to the vehicle caused by poor quality or faulty apps, inadequate programming of apps, insufficient network strength or loss of data during transmission or by misuse of the mobile telephones.

## Applications (apps)

 Please refer to  and  at the start of the chapter on page 227.

Volkswagen App-Connect allows content from Volkswagen apps and third party apps on mobile telephones to be shown on the Infotainment system screen.

There may be problems with compatibility with third-party apps.

Apps, their use, and the necessary mobile network connection may be subject to charges.



A wide range of apps may be available and they may depend on the vehicle and country. The content, scope and providers of apps can vary. Some apps also depend on availability of services offered by third parties.

We are unable to guarantee that the available apps can be run on all mobile telephones and all operating systems.

The apps offered by Volkswagen can also be changed, discontinued, deactivated, reactivated and upgraded without prior notice.

In order to avoid distracting the driver, only certified apps can be used when driving.

## Icons and settings for App-Connect

 Please refer to  and  at the start of the chapter on page 227.

### Symbols in the menu App-Connect

The actual symbols present depend on the installed Infotainment system and the vehicle model.

 Show further information.



Open the App-Connect Settings menu.



Open the App-Connect Settings menu.



Select Apple CarPlay technology.



Select Android Auto™ technology.



Select MirrorLink® technology.

### Possible settings in the App-Connect Settings menu



The setting options depend on the Infotainment system installed.

(Mobile devices): Open Device Manager.

Activate data transfer for VW apps: data transfer for Volkswagen apps is activated.

Allow MirrorLink information to be shown: information is displayed in MirrorLink® mode.

## Apple CarPlay™

 Please refer to  and  at the start of the chapter on page 227.

### Prerequisites

The following conditions must be fulfilled in order to use Apple CarPlay:

- ✓ The iPhone must support Apple CarPlay.
- ✓ Voice control (Siri) must be activated on the iPhone.
- ✓ Apple CarPlay must be activated in the iPhone settings without any restrictions.
- ✓ The iPhone must be connected to the Infotainment system via a USB port. Only USB ports with data transfer capability are suitable for using Apple CarPlay.
- ✓ The USB cable used must be an original cable from Apple.

*Apple CarPlay Wireless:* in addition, Bluetooth and WLAN must be activated on the iPhone.



The availability of the technologies depends on the country and may vary.



 Information on technical requirements, compatible iPhones, certified apps and availability is available on the website of Volkswagen and Apple CarPlay or from your Volkswagen dealership.

### Connecting

Follow the instructions on the Infotainment system screen and the display on the iPhone when establishing a connection for the first time.

The prerequisites for using Apple CarPlay must be fulfilled.

Start Apple CarPlay:

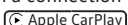
1. Open the App-Connect main menu. To do this, tap  ► .
- Or: press .
2. Establish a connection with the iPhone. To do this, tap .

### Disconnecting

1. To access the App-Connect main menu when in Apple CarPlay mode, tap .
2. Tap  or  to disconnect the active connection.

How the function buttons are displayed on the screen may vary.



### Points to note

Please note the following points during an active Apple CarPlay connection:



- Bluetooth connections between the iPhone and the Infotainment system are not possible.
- An active Bluetooth connection is terminated automatically.
- Telephone functions are possible only via Apple CarPlay. The functions described for the Infotainment system are not available.
- The connected iPhone cannot be used as a media device in the Media main menu.
- It is not possible to use the Apple CarPlay navigation at the same time as the internal navigation. The last route guidance to be started terminates the previous active route guidance.
- Depending on the Infotainment system, the instrument cluster display may show information about telephone mode.
- Depending on the Infotainment system and navigation app used, turning instructions may be shown on the instrument cluster display.
- You can accept or reject incoming calls or end a telephone call via the multifunction steering wheel.

### Voice control

The “voice control” function depends on the vehicle equipment level.

1. Tap  briefly to start voice control of the Infotainment system.  
Or: long-tap  to start voice control (Siri) of the connected iPhone.

## Android Auto™

 Please refer to  and  at the start of the chapter on page 227.

### Prerequisites

- ✓ The mobile telephone – referred to below as a smartphone – must support Android Auto.
- ✓ An Android Auto app must be installed on the smartphone.
- ✓ The smartphone must be connected to the Infotainment system via a USB connection with data transfer function.
- ✓ The USB cable used must be an original cable from the smartphone manufacturer.

*Android Auto Wireless:* in addition, Bluetooth and WLAN must be activated on the smartphone.

 The availability of the technologies depends on the country and may vary.



 Information on technical requirements, compatible smartphones, certified apps and availability are available on the Volkswagen and Android Auto websites or from a Volkswagen dealership.

### Connecting

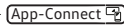

Follow the instructions on the Infotainment system screen and the display on the smartphone when establishing a connection for the first time.

The requirements for using Android Auto must be met.

Start Android Auto:

1. Tap  ► .
- Or: press .
2. Tap  to establish a connection with the smartphone..

### Disconnecting

1. To access the App-Connect main menu when in Android-Auto mode, tap .
2. Tap  to disconnect the active connection.



## Points to note

The following points apply when an Android Auto connection is active:



- An active Android Auto device can also be connected simultaneously to the Infotainment system via Bluetooth (HFP profile).
- Telephone functions are possible via Android Auto. If the Android Auto device is connected to the Infotainment system via Bluetooth at the same time, the telephone function on the Infotainment system can also be used.
- An active Android Auto device cannot be used as a media device in the **Media** main menu.
- It is not possible to use the Android Auto navigation at the same time as the internal navigation. The last route guidance to be started terminates the previous active route guidance.
- The instrument cluster display shows information about the telephone mode.
- Depending on the Infotainment system and navigation app used, turning instructions may be shown on the instrument cluster display.
- You can accept or reject incoming calls or end a telephone call via the multifunction steering wheel.

## Voice control

The voice control function depends on the vehicle equipment level.

1. Tap  briefly to start voice control of the Infotainment system.  
**Or:** long-tap  to start voice control of the connected smartphone.

## MirrorLink®

 Please refer to  and  at the start of the chapter on page 227.

## Function buttons

**APP** Goes back to the **App-Connect** main menu. Here you can end the MirrorLink connection, connect another mobile telephone or select another technology.

 Tap to close any open apps. Then tap apps to be closed or tap the function button **Close All** to close all open apps.

 Tap to display the screen of the mobile telephone on the screen of the Infotainment system.



Open the MirrorLink settings.



Tap to return to the MirrorLink main menu.

## Prerequisites

- ✓ The mobile telephone must support MirrorLink.
- ✓ The mobile telephone must be connected to the Infotainment system via a USB connection with data transfer.
- ✓ The USB cable used must be an original cable of the mobile telephone manufacturer.
- ✓ Depending on the mobile telephone used, a suitable Car Mode app for using MirrorLink must be installed on the device.



Information on technical prerequisites, compatible mobile telephones, certified apps and availability is available on the homepage of Volkswagen and MirrorLink or from your Volkswagen dealership.

## Connecting

Follow the instructions on the Infotainment system screen and the display on the mobile telephone when establishing a connection for the first time.

The prerequisites for using MirrorLink must be met.

Start MirrorLink:

1. Tap **[MENU]** ► **[App-Connect]**.

**Or:** press **[APP]**.

2. Tap **[MirrorLink]** to establish a connection with the mobile telephone.

## Disconnecting

1. To access the **App-Connect** main menu when in MirrorLink mode, tap **[APP]**.

**Or:** tap **[☒]** to go to the MirrorLink main menu.

2. Tap **[☒]** to disconnect the active connection.

## Points to note

The following points need to be noted during an active MirrorLink connection:

- An active MirrorLink device can also be connected simultaneously to the Infotainment system via Bluetooth.
- If the MirrorLink device is connected to the Infotainment system via Bluetooth, the telephone function on the Infotainment system can also be used.



- An active MirrorLink device cannot be used as a media device in the Media main menu.
- The instrument cluster display shows information about the telephone mode.
- No information about turning off at junctions or media mode displays are shown on the instrument cluster display.
- You can accept or reject incoming calls or end a telephone call via the multifunction steering wheel.

## Cable and wireless connections

### Introduction to the topic

Some external devices can be connected to the Infotainment system by cable and wireless connections present in the vehicle, if installed.

The type and number of cable and wireless connections differ according to country and vehicle equipment. The connections may also be different within a model series or in special-edition models.

In the case of cable connections, use only the original device connecting cables or, if available, the factory-supplied connecting cables for your vehicle.

If the plug on the connecting cable cannot be inserted, check the angle of insertion and the connections.

### NOTICE

Use only suitable and undamaged connecting cables for cable connections.

- When inserting the plugs of the connecting cables into the appropriate connection, ensure that they are correctly positioned and apply only light pressure. Applying too much pressure may damage both the unit connection and the plug of the connecting cable.
- Make sure that the connecting cable is not pinched or sharply bent.
- Using unsuitable or damaged connecting cables may damage devices and cause malfunctions.

**i** If a connected device is not recognised, disconnect all devices and connect the device again. If necessary, check that the connecting cable you are using is working properly.

**i** If a connected device malfunctions, restart the device. In some cases this will remedy the fault.

## USB port

**i** Please refer to **1** at the start of the chapter on page 231.

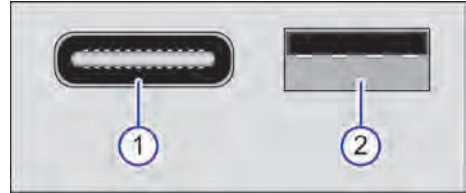

Fig. 174 Possible USB ports in the vehicle (illustration).

- 1** USB port, Type C.
- 2** USB port, Type A.

### USB port types

The following USB ports may be available in the vehicle:

- Type A : suitable for data transfer and the charging function.
- Type A : suitable for charging function only.
- Type C : suitable for data transfer and the charging function.
- Type C or : suitable for charging function only.

Each USB port is a cable connection which can be operated only using a suitable connecting cable.

The USB port supplies the customary USB voltage of 5 volts.

The USB types and also the number and installation locations of the USB ports depend on the vehicle and country.

Only supported audio files are displayed. Other files will be ignored.

The Infotainment system only supports mass storage and audio sources in “mass storage mode”. Please refer to the description of your audio source on how to activate this mode.

Audio files on an external data medium connected to the USB port can be played and controlled via the Infotainment system.



**i** Before connecting an audio source, check which USB port is installed in your vehicle. Use only suitable USB connecting cables which are appropriate for the respective USB type.

- USB ports “Type A” and “Type C” have different connector shapes.

### Possible fitting locations of USB ports

- On the front of the Infotainment system.
- in the storage compartment of the centre armrest in the front.
- In the centre console.

### Connecting the external data media to the USB port

1. Reduce the volume on the Infotainment system.
2. Connect external data medium to the USB port .
3. Start playback on the external audio source.
4. To open the Media menu, tap .
5. Tap **Source** and select  **My media** as the media source.



iPod-specific list views (**Playlists**, **Artists**, **Albums** etc.) can be displayed under  or **LIST**.

### Notes and restrictions



The number of USB ports  and compatibility with Apple devices as well as other media players depend on the equipment level.

Due to the large variety of data storage devices and the various iPod, iPad and iPhone generations available, it is not possible to guarantee fault-free operation of all functions described here.

Depending on the Infotainment system used, external hard drives with a capacity greater than 32 GB sometimes have to be reformatted for the FAT32 file system. You can find the necessary software and information online, for example.

 Do not connect or use USB extension cables or USB hubs. 

## Bluetooth® interface

 Please refer to  at the start of the chapter on page 231.

The Bluetooth interface is a wireless connection.

In Bluetooth audio mode, audio files from a Bluetooth audio source, e.g. mobile telephone, that is connected via Bluetooth can be played over the vehicle loudspeakers.

Bluetooth audio mode is available if the vehicle is equipped with a factory-fitted mobile phone interface that supports this function.

### Bluetooth profiles

The Infotainment system is delivered from the factory with a Bluetooth interface.

A maximum of three Bluetooth devices can be connected at the same time.

The following Bluetooth profiles may be available in the specified or different version:

- HFP 1.7.
  - Telephony and handsfree mode.
- A2DP 1.3.
  - Music playback.
- AVRCP 1.6.
  - Display and operation of music playback.
  - Transmission of Cover Arts.
- PBAP 1.2.
  - Access to phone book and call lists.
- MAP 1.4.
  - Access to SMS and email.
- SPP 1.2.
  - Serial data transmission via Bluetooth.

### Starting Bluetooth audio transmission

Prerequisites:

- ✓ The Bluetooth audio source is paired with and connected to the Infotainment system  
→ page 260.
- ✓ The Bluetooth audio source supports the A2DP Bluetooth profile.

1. Reduce the volume on the Infotainment system.
2. Activate Bluetooth visibility on the external Bluetooth audio source, e.g. mobile telephone.
3. Open the **Media** menu.
4. Tap **Source** and select  **BT audio**.
5. If necessary, start playback on the Bluetooth audio source manually.

When playback on the Bluetooth audio source is stopped, the Infotainment system remains in Bluetooth audio mode.

### Controlling playback



The extent to which the Bluetooth audio source can be controlled via the Infotainment system varies depending on what Bluetooth audio source is connected.

With media players that support the AVRCP Bluetooth profile, playback on the Bluetooth audio source can be automatically started or stopped when the unit is switched to Bluetooth audio mode or to a different audio source. Depending on the Bluetooth audio source, it may also be possible to

display the track and change the track using the Infotainment system.

 Due to the large number of possible Bluetooth audio sources, it is not possible to guarantee fault-free operation of all described functions.



 Always switch off the warning and service tones on a connected Bluetooth audio source, e.g. key tones on a mobile telephone, to prevent interference noise and malfunctions.

 With some devices, the Bluetooth audio connection will be disconnected automatically if an external media player is simultaneously connected to the Infotainment system with Bluetooth and the USB port . 

### Controlling playback

The extent to which the WLANaudio source can be controlled via the Infotainment system varies depending on what WLAN audio source is connected. 

## Connecting an external audio source via Wi-Fi

 Please refer to  at the start of the chapter on page 231.

The WLAN connection is a wireless connection.





In WLAN audio mode, sources connected via WLAN, e.g. mobile telephones, can be used for audio transmission.



The availability of the WLAN function varies depending on country and the Infotainment system used.

### Prerequisites

- ✓ The connected audio source has a suitable app or supports media enabling under the UPnP standard.
- ✓ The WLAN connection to the audio source is established.

### Starting Wi-Fi audio transmission

1. Reduce the volume on the Infotainment system.
2. To open the Media main menu, tap  .
3. Start the UPnP server application or suitable app for audio playback on the Wi-Fi audio source.
4. Tap  and select  Wi-Fi.
5. Observe the information on the further procedure on the Infotainment system screen and on the WLAN audio source screen.

The function button for selecting the audio source  in the Media main menu may vary if another audio source is already connected to the Infotainment system, e.g. via USB  and is selected.

# Infotainment system

## Getting started

### Introduction to the topic

The functions and settings of the Infotainment system depend on the equipment and are not available in all countries.

#### Before using for the first time

Before using the Infotainment system for the first time, please observe the following points so you can make full use of the available functions and settings:

- Observe the safety instructions → page 234.
- Reset the Infotainment system to factory settings.
- Find your favourite radio stations and store them to station buttons for quick access → page 245.
- Use only suitable audio sources and data media → page 248.
- Use current map data for the navigation system.
- Pair a mobile telephone to make calls using the mobile phone interface → page 257.
- Register with We Connect to use the corresponding services.

#### Other applicable documents

In addition to this manual, please observe the following documents when using this Infotainment system and its components:

- Supplements to the vehicle wallet of your vehicle.
- The operating instructions for the mobile telephone or audio sources.
- The operating instructions for external data media and playback devices.
- Instructions for any Infotainment accessories subsequently installed or additionally used.
- Service description when using We Connect services.
- Digital instructions in the Infotainment system, where available.

### Safety notes

 Please refer to  and  on page 234.

- Some functions may contain links to websites that are operated by third parties. Volkswagen does not assume ownership of the third-party

websites that are reached via links and is not responsible for their content.

- Some functions may contain external information supplied by third parties. Volkswagen is not responsible for external information being correct, up-to-date and complete, or for any infringement of third-party rights.
- The radio stations or owners of the data storage media and audio sources are responsible for the content provided.
- Mobile, GPS and radio signals can also be impaired by multi-storey car parks, garages, underpasses, tunnels, tall buildings, mountains, valleys, and other electrical devices such as battery chargers.
- Films or metal-coated stickers on the aerial and on the windows can interfere with radio reception.
- Read and follow the appropriate operating manuals of the respective manufacturer when using mobile telephones, data media, external devices, external audio and media sources.

#### WARNING

The central computer of the Infotainment system is networked with the control units in the vehicle. For this reason, improper repairs or incorrect removal and installation of the central computer could constitute an increased risk of accident and injury.

- Never replace the central computer with a used central computer taken from an older vehicle or a recycling facility.
- Only have the central computer removed, installed or repaired by a specialist company qualified to perform this work. Volkswagen recommends using a Volkswagen dealership.

#### WARNING

Accidents and injuries can occur if the driver is distracted. Reading information from the screen, operating the Infotainment system and connecting, inserting or removing a data medium or audio source while driving can distract you from the traffic situation and cause accidents.

- Drive with your full attention and with responsibility.

#### WARNING

Unfavourable light conditions and a damaged or dirty screen may result in displays and information not being read or not being read correctly from the screen.

- Displays and information on the screen must never cause you to take safety risks. Drive with your full attention and with responsibility.

### WARNING

If you set the volume at too high a level, this will mean that you will not hear acoustic signals from outside, and it can also damage your hearing. This is the case even if you are only exposed to high volumes for short periods.

- Set the volume so that you can still always hear acoustic signals from outside the vehicle (e.g. emergency service sirens).

### WARNING

The volume level may suddenly change when you switch the audio or media source or connect a new source.

- Reduce the volume before switching the audio or media source or connecting a new source.

### WARNING

The following conditions can lead to situations where emergency calls, telephone calls and data transmission are not possible or are interrupted:

- If your current location is in an area with no or insufficient mobile communications and GPS reception.
- If you are in an area with sufficient mobile communications and GPS reception but the telecommunications provider's mobile network is out of order or is not available.
- If the components in the vehicle required for emergency calls, telephone calls and data transmission are damaged, not working or do not have sufficient electrical power.
- If the rechargeable battery in the mobile telephone is flat or has insufficient charge level.

### WARNING

Radio stations can transmit catastrophe and danger warnings. The following conditions can prevent these warnings from being received or issued:

- If your current location is in an area with no or insufficient radio signal reception.
- If the frequency bands of the radio stations are subject to interference or are not available in areas with adequate radio signal reception.
- If the loudspeakers and the components required for radio reception in the vehicle are damaged, not working or do not have a sufficient power supply.

### WARNING

In some countries and mobile networks, a call for assistance or an emergency call can be made only subject to the following prerequisites:

- A mobile telephone with unlocked SIM card and sufficient call credit is connected to the mobile phone interface of the vehicle.
- Sufficient network coverage is available.

### WARNING

If mobile telephones or two-way radios that are not connected to an external aerial are used, electromagnetic radiation in the vehicle could exceed limit values and thus be a health hazard for drivers and other vehicle occupants. This also applies to external aerials which have not been correctly installed.

- Maintain a minimum distance of 20 cm (around 8 inches) between the aerials on the mobile telephone and an active medical implant, such as a pacemaker, since the mobile devices may impair the function of active medical implants.
- Do not carry an operational mobile telephone in close proximity to or directly above an active medical implant, e.g. in a breast pocket.
- Switch off mobile telephones immediately if you suspect they may be interfering with an active medical implant or any other medical device.

### WARNING

Mobile telephones, external devices and accessories in the vehicle that are not properly secured can be flung through the vehicle interior and cause injuries in the event of a sudden driving or braking manoeuvre or in the event of an accident.

- Safely secure or stow any mobile telephones and accessories outside the deployment zone of the airbags.
- Arrange the wires for external devices and audio sources so that they do not obstruct the driver.

### WARNING

Driving recommendations and traffic symbols displayed by the navigation system may differ from the current traffic situation.

- Road signs, traffic signals, traffic regulations and local conditions have priority over the recommendations and displays provided by the navigation system.
- Adapt your speed and driving style to the current visibility, weather and road or traffic conditions.

- Certain events can make the originally planned driving time and route to the destination considerably longer or make navigation there temporarily impossible, e.g. due to a road being closed.

### ! NOTICE

The radiation produced by the mobile telephone when switched on may interfere with sensitive technical and medical equipment, possibly resulting in malfunction or damage to the equipment.

- Always switch off your mobile telephone in areas where special regulations apply and when the use of mobile devices is forbidden.

### ! NOTICE

The loudspeakers can be damaged if the volume is set at too high a level and by playback which is too loud or distorted.

- Choose the volume setting so that the loudspeakers are not damaged.

## Notes on use

📖 Please refer to  and  on page 234.

- The Infotainment system needs a few seconds for a complete system start and does not respond to inputs during this time. During system startup, only the rear view camera image can be displayed.
- The Infotainment system must start up completely before all displays are available and before it is possible to execute functions. The duration of a system start depends on the functional scope of the Infotainment system and can also take longer than usual particularly at low and high temperatures.
- When using the Infotainment system and the corresponding accessories, such as a headset or headphones, please observe the regulations and legal requirements in the relevant country.

- To ensure that the Infotainment system functions correctly, it is important to make sure the system is switched on and that, where applicable, the correct date and time are set in the vehicle.
- A missing function button on the screen does not constitute a fault in the unit; It reflects the equipment that is available in the country in question.
- Some of the functions and settings of the Infotainment system are available only when the vehicle is stationary. In some countries, the selector lever must also be in parking position P or neutral position N. This is not a malfunction, but simply a legal requirement.
- There may be restrictions on the use of Bluetooth® devices in some countries. Information is available from the local authorities.
- Switch the ignition on before switching the Infotainment system back on if the 12-volt vehicle battery has been disconnected.
- If settings are modified, displays on the screen may vary and the Infotainment system may behave differently from the description in this manual in some cases.
- The Infotainment system switches off automatically when the engine is switched off and when the charge level of the 12-volt vehicle battery is low.
- In certain vehicles with Park Distance Control, the volume of the current audio source is lowered automatically when reverse gear is engaged. It is possible to lower the volume.
- Information on the software and the licence conditions is stored in the Infotainment system: **Settings ▶ Copyright**.
- If you sell your vehicle or loan it to somebody else, make sure that all the stored data, files and settings are deleted and that the external SD card, external audio sources and data media are removed where applicable.
- Some Infotainment system functions require a We Connect user account for the vehicle and an Internet connection. The data transfer must not be restricted for the execution of the functions.

## Overview and controls of the 9.2" version

Please refer to  and  on page 234.



Fig. 175 Overview: display and operating unit of the 9.2" version.

- ① **MENU**.
- ② **HOME**.
- ③ Sensor field (Infotainment system on or off).
- ④ Sensor fields (louder and softer).
- ⑤ Function buttons for main menus.
- ⑥ Control Centre.
- ⑦ Screen (touchscreen).
- ⑧ Views (current view is highlighted).
- ⑨ Status bar.

 Further information and tips for operating the Infotainment system are provided on → page 241, *Operating the Infotainment system*.

### ① and ② **MENU** and **HOME**

- Tap **MENU** to open the start screen.
- Tap **HOME** to open the views.

### ③ **Sensor field (Infotainment system on or off)**

1. Tap the sensor field to switch the Infotainment system on or off manually.

### ④ **Sensor fields (increase or reduce volume)**

1. Tap the sensor fields to adjust the volume.

### ⑤ **Function buttons for main menus**

The position of the function buttons can be configured → page 242.

1. Tap the corresponding function button to open a main menu, e.g.  for the mobile phone interface.

### ⑥ **Control Centre**

There are additional function buttons for functions and notifications in the Control Centre. You can configure the displayed functions → page 242.

1. Tap the marking and drag it down to open the Control Centre.

### ⑦ **Screen (touchscreen)**

You can operate the functions of the Infotainment system using the screen. You can find a detailed explanation of the different finger gestures in the digi-

tal instructions on the Infotainment system, where available.

1. Tap **[MENU]** ► **[?]** ► **Bedienung**.

### ⑧ Views (current view is highlighted)

Some menus and functions have several views with different content. The current view is highlighted.

- Tap the marking to change to a view.
- Swipe your finger to the left or to the right across the screen to switch between views.

### Scroll bar (without item number)

Some menus and functions have further content above or below the current screen view.

1. Tap the scroll bar and drag it up or down to display additional content.

### Gesture control (without item number)

You can also switch on gesture control. When gesture control is switched on, this is indicated on the screen.

1. Tap **[MENU]** ► **[Settings]** ► **Screen** ► **Hand gesture**.



## Overview and controls of the 8" version

📖 Please refer to **▲** and **!** on page 234.



**Fig. 176** Overview: display and operating unit of the 8" version

### ① Possible sensor fields for opening main menus:

- **[RADIO]** → page 245.
- **[MEDIA]** → page 248.
- **[PHONE]** → page 257.
- **[VOICE]** → page 262. The button has no function in some countries.
- **[NAV]** → page 251.

– **[APP]** → page 227. The button has no function in some countries.

– **[SOUND]**.

– **[CAR]**.

– **[MENU]** Open the start screen.

② Rotary pushbutton.

③ Function buttons for main menus.

④ Views (current view is highlighted).

⑤ Control Centre.



## ⑥ Menu control.

 Further information and tips for operating the Infotainment system are provided on → page 241, *Operating the Infotainment system*.

## ① Sensor fields

1. Tap the corresponding sensor field to open a main menu, e.g.  for the mobile phone interface.

## ② Rotary pushbutton

- Press to switch the Infotainment system on or off.
- Turn anti-clockwise to reduce the volume.
- Turn clockwise to increase the volume.

## ③ Function buttons for main menus

The position of the function buttons cannot be configured.

1. Tap the corresponding function button to open a main menu, e.g.  for the mobile phone interface.

## ④ Views (current view is highlighted)

Some menus and functions have several views with different content. The current view is highlighted.

- Tap the marking to change to a view.
- Swipe your finger to the left or to the right across the screen to switch between views.

## ⑤ Control Centre

There are additional function buttons for functions and notifications in the Control Centre. You can configure the displayed functions → page 242.

1. Tap the marking and drag it down to open the Control Centre.

## ⑥ Menu control

1. Turn to select from a list.
2. Press to confirm a selection.

## Screen (touchscreen) (without item number)

You can operate the functions of the Infotainment system using the screen. You can find a detailed explanation of the different finger gestures in the digital instructions on the Infotainment system, where available.

1. Tap  ►  ► *Bedienung*.

## Scroll bar (without item number)

Some menus and functions have further content above or below the current screen view.

1. Tap the scroll bar and drag it up or down to display additional content.

## Gesture control (without item number)

You can also switch on gesture control. When gesture control is switched on, this is indicated on the screen.

1. Tap  ►  ► *Screen* ► *Hand gesture*.



## Overview and controls of the 6.5" version

Please refer to ▲ and ① on page 234.

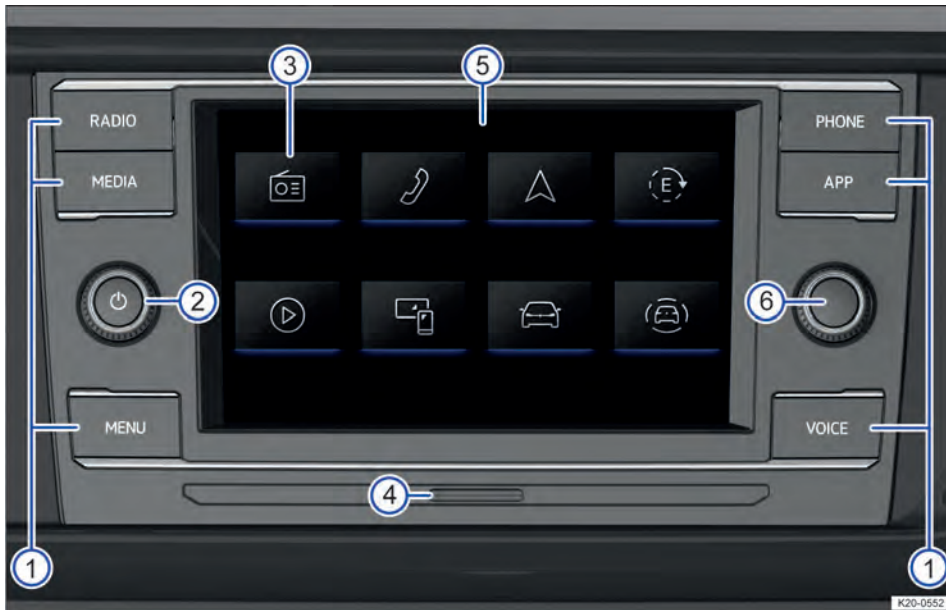

Fig. 177 Overview: display and operating unit of the 6.5" version.

- ① Function buttons for opening the main menus:
  - **RADIO** → page 245.
  - **MEDIA** → page 248.
  - **MENU** Open the start screen.
  - **PHONE** → page 257.
  - **APP** → page 227. The button has no function in some countries.
  - **VOICE** → page 262. The button has no function in some countries.

- ② Rotary pushbutton.
- ③ Function buttons for main menus.
- ④ SD card slot → page 241.
- ⑤ Screen (touchscreen).
- ⑥ Menu control.

**i** Further information and tips for operating the Infotainment system are provided on → page 241, *Operating the Infotainment system*.

### ① Function buttons

- Tap the corresponding function button to open a main menu, e.g. **PHONE** for the mobile phone interface.
- Press **MENU** to open the start screen.
- Press and hold **VOICE** to start voice control of the connected mobile telephone.

### ② Rotary pushbutton

- Press to switch the Infotainment system on or off.
- Turn anti-clockwise to reduce the volume.
- Turn clockwise to increase the volume.

### ③ Function buttons for main menus

The position of the function buttons cannot be configured.

1. Tap the corresponding function button to open a main menu, e.g. **PHONE** for the mobile phone interface.

## 5 Screen (touchscreen)

You can operate the functions of the Infotainment system using the screen. You can find a detailed explanation of the different finger gestures in the digital instructions on the Infotainment system, where available.

1. Tap **[MENU]** **Bedienung**.

## Media drives

Please refer to and on page 234.

### SD card slot

Depending on equipment, an SD card slot is not available in all Infotainment systems and not in all countries.

To use stored media such as audio files or media files in the Infotainment system, insert a compatible SD card into the SD card slot. Supported file formats are displayed in the Infotainment system. Other file formats will be ignored.

Dimensions of compatible SD cards:

- ✓ 32 mm x 24 mm x 2.1 mm (approx. 1 in x 0.94 in x 0.083 in)
- ✓ 32 mm x 24 mm x 1.4 mm (approx. 1 in x 0.94 in x 0.055 in)

### Inserting an SD card safely

1. Insert the SD card into the SD card slot with the cut-off corner first and the contact surfaces facing down until you feel the card click into place.  
  
If the SD card cannot be inserted, ensure that the SD card is compatible and that it is positioned correctly.

### NOTICE

The SD card slot, SD card or both may be damaged if you insert SD cards with force, if an SD card has the wrong dimensions or if you use an SD card adapter. If you insert other objects, e.g. SIM cards, in the SD card slot, the object, SD card slot or both may be damaged.

- Do not use excessive force when inserting SD cards.
- Observe the dimensions of compatible SD cards.
- Do not use any SD card adapters.

## 6 Menu control

1. Turn to select from a list.
2. Press to confirm a selection.

If the Infotainment system cannot read the data of an SD card, a corresponding message will be displayed on the screen.

An SD card with navigation data cannot be used as a storage device for other files. Stored files will not be recognised by the Infotainment system.

## Operating the Infotainment system

Please refer to and on page 234.

### Opening the instructions (if available)

You can find further information and tips for operation in the digital instructions for the Infotainment system.

1. Tap **[HOME]** **Guide**.

### Switching the Infotainment system on and off

If the Infotainment system was not manually switched off before, the Infotainment system will start up when the ignition is switched on.

If the last set volume does not exceed the preset maximum switch-on volume, the Infotainment system will start up at this volume.

Vehicles with ignition lock: the Infotainment system switches off automatically when the vehicle key is removed from the ignition lock.

Vehicles with starter button: the Infotainment system switches off automatically when the driver door is opened with inactive ignition.

If you switch on the Infotainment system manually when the ignition is inactive, it will switch off automatically after around 30 minutes without a user input.

### Opening the start screen

1. Tap **[MENU]** page 237, page 238, page 240.

## Main menus on the start screen

The following main menus may be included as function buttons on the start screen:



Background lighting → page 110.



App-Connect → page 227.



Apps.



Driver assistance → page 168.



Vehicle → page 17.



Help: here you can find further information on the functions and operation of the Infotainment system.



Air conditioning → page 119.

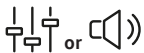

Sound → page 243.



Media → page 248.



Navigation → page 251.



Users, User management.



Radio → page 245.



Legal.



Settings → page 243.



Auxiliary heater.



Telephone → page 257.

## Configuring the start screen

You can configure the layout of the function buttons and also the views and displays on the start screen

of the display and operating unit or have them positioned on the basis of factory layout templates.

It is not possible to configure the start screen in all available Infotainment systems.

1. Tap a function button and hold until the function button is visibly highlighted.
2. Move the function button to the desired position and release.

## Scrolling through lists, switching tracks

Use the touchscreen or menu control to select the desired function, setting or track.

## Moving objects, adjusting volume

Move objects on the screen to adjust settings, e.g. of sliders, or to move areas of a menu.

Personalise function buttons and views (this depends on the vehicle equipment level) → page 242.

## Enlarging and reducing images and maps on the screen

Recommendation: use thumb and index finger.

1. Using two fingers at the same time, tap the screen and keep your fingers on the screen.
  - To enlarge the display of images and maps, slowly move your fingers apart.
  - To reduce the display of images and maps, slowly move your fingers together.

## Personalising the Infotainment system

Please refer to  and  on page 234.

Depending on equipment, you can personalise the Infotainment system to permit faster access to favourite or frequently used functions.

## Adapting tiles

You can find tiles for accessing further menus and functions on the Infotainment system displays.

Configure tiles and the displayed functions of the tiles in the Infotainment system views to adapt the Infotainment system to your needs.

1. Tap a tile and hold until an additional window opens.
2. Tap the desired function in the additional window. Various functions are available depending on the size of the tile.

**Or:** tap a free area on the screen to return to the view.

 At least two tiles are always available. These cannot be removed. With some equipment levels, you can add two more tiles. In total, a maximum of four tiles can be displayed.

 More functions are available for some tiles than are visible at first glance in the additional window. Swipe up or down in the additional window to see all functions.

### Adapting the Control Centre

Personalise the Control Centre of the Infotainment system to permit faster access to favourite or frequently used functions.

1. Tap a function and hold until an additional window opens.
2. Tap the desired function in the additional window and hold until the function is visibly highlighted.
3. Move the function to the desired position and release.

The active function is automatically removed from the Control Centre and added to the additional window.

 More functions are available for the Control Centre than are visible at first glance in the additional window. Swipe to the left or right in the additional window to see all functions.

### Opening the instructions (if available)

You can find further information and tips for personalisation in the digital instructions for the Infotainment system.

1. Tap **HOME** ►  ►  ► Custom.

## System and sound settings

 Please refer to  and  on page 234.



### Changing settings

The meanings of the following symbols apply to all system and sound settings.

Changes are automatically stored when a menu is closed.

or  The setting is selected and activated or switched on.

or  The setting is not selected and is deactivated or switched off.

 or  Open the drop-down list.

 Increase the setting values.

 Decrease the setting values.

 Gradually back.

 Gradually forwards.

 Change setting values with the slider control (infinitely variable).

### System settings

The following functions, information and setting options may be available in the system settings:

- Screen.
- Time and date.
- Language.
- Additional keyboard languages.
- Units.
- Voice control.
- Wi-Fi.
- Data connection.
- Manage mobile devices.
- Reset to default settings.
- System information.
- Copyright.
- Configuration assistant.

### Opening the system settings

1. Tap **HOME** ► Settings.  
Or: tap **MENU** ► Settings.

### Sound settings

The sound settings may contain information and setting options for equaliser, position, volume and settings.

### Opening the sound settings

1. Tap **HOME** ► Sound.  
Or: tap **MENU** ► Sound.

## Adjusting the volume of external audio sources

If you need to increase the output volume of an external audio source, first lower the volume on the Infotainment system.

If the sound from the external audio source is too quiet, increase the output volume of the external audio source. If this is not sufficient, set the input volume to **Medium** or **Loud**.

If the sound from the connected external audio source is too loud or distorted, lower the output volume on the external audio source. If this is not sufficient, set the input volume to **Medium** or **Quiet**.

## Cleaning the screen

📖 Please refer to ▲ and ⓘ on page 234.

Observe this checklist when cleaning the screen:

- ✓ The Infotainment system is switched off.
- ✓ Use a clean, soft cloth that is moistened with water.
  - Or:** use a cleaning cloth available from Volkswagen dealerships.
- ✓ In the case of stubborn dirt:
  - Moisten dirt with only a little water and allow to soak in.
  - Carefully remove dirt with a clean, soft cloth.

### ! NOTICE

You can damage the screen if you clean the screen with the wrong cleaning agents or when the screen is dry.

- Use only gentle pressure.
- Do not use aggressive or solvent-based cleaning products. These cleaners may damage the device and dull the screen.

### ! NOTICE

If the screen is cleaned with too much moisture, it may no longer be possible to operate the screen or the screen may switch off.

- Dry the screen then leave the vehicle locked from the outside for at least 2 minutes.

## Marks, licences, copyright

📖 Please refer to ▲ and ⓘ on page 234.

### Marks and licences

Certain terms in this manual are accompanied by the symbol ® or ™. These symbols indicate trademarks or registered marks. However, the absence of these symbols does not constitute a waiver of the rights concerning any term.

Other product names are registered marks of the respective legal owners.

- Manufactured under license from Dolby Laboratories. Dolby and the double-D symbol are trademarks of Dolby Laboratories.
- Manufactured under license from Dolby Laboratories. Dolby, Pro Logic and the double-D symbol are trademarks of Dolby Laboratories.
- All SiriusXM services require a subscription. See the SiriusXM Customer Agreement for complete terms at [www.siriusxm.com](http://www.siriusxm.com) (US) or [www.siriusxm.ca](http://www.siriusxm.ca) (Canada). All fees, content and features are subject to change. Satellite and steaming line-ups may vary. SiriusXM, Pandora and all related logos are trademarks of Sirius XM Radio Inc. and its respective subsidiaries. All rights reserved.
- HD Radio Technology manufactured under license from iBiquity Digital Corporation. U.S. and Foreign Patents. For patents see <http://dts.com/patents>. HD Radio, Artist Experience, and the HD, HD Radio, and "ARC" logos are registered trademarks or trademarks of iBiquity Digital Corporation in the United States and/or other countries.
- Android Auto™ is a certified trademark of Google Inc.
- Apple CarPlay™ is a certified trademark of Apple Inc.
- Bluetooth® is a registered trademark of Bluetooth® SIG, Inc.
- iPod®, iPad® and iPhone® are trademarks of Apple Inc.
- MirrorLink® and the MirrorLink® logo are certified trademarks of Car Connectivity Consortium LLC.
- MPEG-4 HE-AAC audio coding technology and patents are licensed by Fraunhofer IIS.
- SD® and SDHC® are brands or registered trademarks of SD-3C LLC in the USA and other countries.
- Windows® is a registered trademark of Microsoft Corporation, Redmond, USA.
- This product is subject to certain intellectual property rights and copyrights owned by the Mi-

icrosoft Corporation. The use or distribution of this type of technology outside this product requires a licence from Microsoft or an authorised Microsoft company.

### Copyright law

Audio and video files saved on data media and audio sources are normally subject to national and international copyright laws. Observe the legal requirements.

## Radio mode

### Introduction to the topic

In radio mode, you can receive available radio stations on different frequency bands and store your favourites to station buttons for quick access.

The available reception modes and frequency bands are dependent on the equipment level and are not available in all countries. Frequency bands may be discontinued, deactivated or no longer offered in individual countries.

### Opening the RADIO menu

1. Tap **HOME** ▶ ▶ .  
Or: tap **MENU** ▶ .  
Or: tap **RADIO**.

### Opening settings

1. Tap **HOME** ▶ ▶ ▶ **Radio**.  
Or: tap **MENU** ▶ ▶ .

The radio stations are responsible for the content of the information sent.

Additional electrical devices connected in the vehicle can interfere with reception of the radio signal and cause noises in the loudspeakers.

Foil or metal-coated stickers attached to the windows may affect reception on vehicles with a window aerial.

## Equipment scope and radio symbols

Please refer to and on page 234.

### Radio

The available functions and possible reception modes and frequency bands depend on the vehicle equipment and are not available in all countries.

- AM tuner.
- FM dual tuner (antenna diversity).
- FM station list.
- Combined station list.
  - Combination of FM- and DAB stations in one list.
- Combined preset list.
  - Combination of all stations stored to station buttons in one list.
  - 36 station buttons as storage locations for favourites.
- Station logos.
- Aerial amplifier.
- DAB/DAB+.
- DAB slide show.
  - Stationary images are transmitted parallel to the current broadcast.
- Internet Radio.

### General symbols in radio mode

The appearance of the symbols may differ depending on Infotainment system.

Select AM reception mode.

Select FM reception mode.

Select FM/DAB reception mode.

Select Internet Radio reception mode.

Select previous station from the station list or station on previous station button.

Select next station from the station list or station on next station button.

Display station buttons.

 Display selected station with additional information.

 Station already stored to a station button in a station list.

**TP** Traffic news monitoring (TP) is activated.

**No TP** The selected traffic news station is not available.

**AF off** Automatic station tracking (AF) is switched off.

**RDS off** Radio Data System (RDS) is switched off.

### Symbols in the AM frequency band

 Display list of AM stations.

 Update station list manually.

 Display frequency band for manual selection of AM frequency.

### Symbols in the FM and FM/DAB frequency band

 Display station list of FM stations and, depending on country, DAB stations.

 Display frequency band for manual selection of FM frequency.  
Possible only if the combined station list is switched off.

 No DAB reception possible.

 DAB station supports slide show.

 Slide show is not available for the DAB station.

### Symbols in Internet Radio mode

 Open full-text search.

 No Internet Radio reception possible.

 Display recently listened to internet radio stations.

**TOP 100** Display 100 most frequently listened to internet radio stations.

 Display available internet radio podcasts.

 Display internet radio stations from the desired country.

 Display internet radio stations that broadcast in the desired language.

 Display internet radio stations who broadcast programmes from the desired genre.

 Display station selection.

## Tuning to, selecting and storing stations

 Please refer to  and  on page 234.

### Selecting a frequency band or reception mode

Before selecting a station, you must first select a frequency band or reception mode. Different stations are available depending on the selected frequency band or reception mode.

The available frequency bands and reception modes are dependent on the equipment level and are not available in all countries.

1. Tap **Source** to open the list of frequency bands and reception modes.
2. Select frequency band or reception mode:
  - AM, if available.
  - FM/DAB.
  - FM (for devices without DAB support).
  - DAB (for 6.5" devices).
  - Internet Radio.
  - Satellite radio.

### Searching for and selecting stations

You can select radio stations in different ways. The possibilities vary depending on frequency band and reception mode.

#### Selecting via frequency band (AM and FM)

1. Display frequency band.
2. Tap the cursor, move on the frequency band and release at the desired frequency.

**Or:** tap a point on the frequency band. The cursor automatically jumps to the corresponding frequency.



The station at the set frequency is set.

### **Selecting from station list (AM, FM and FM/DAB)**

The station list shows the stations that can currently be received. Depending on equipment, it may be necessary to manually update the station list if you have left the corresponding region since you last opened the station list. In the FM/DAB frequency band, the station list normally updates itself automatically.

1. Open the station list.
2. Tap the desired station.

The selected station is set.

In the FM/DAB frequency band, the best reception mode is selected automatically according to availability of the station.

### **Searching for and filtering stations (Internet Radio)**

In Internet Radio mode, it is possible to filter stations according to categories or search for stations by means of a full-text search.

1. Open the station selection.
2. Select the category according to which you wish to filter the stations.

**Or:** tap  to start the full-text search.

The input field is displayed.

3. Enter the name of the desired station.  
The list of found stations is automatically updated during input.
4. Tap the desired station.  
The selected station is set.

### **SCAN Searching in SCAN mode (AM, FM and FM/DAB)**

In SCAN mode, the radio tunes to each station on the frequency band in turn and plays it for around 5 seconds.

1. Tap  **SCAN** to start the SCAN function.  
The SCAN function starts and the currently set station is shown on the display.  
The SCAN function button is shown.
2. To select a station, tap SCAN.  
The SCAN function stops and the station is set.

### **Storing stations to station buttons**

You can store up to 36 stations from different frequency bands and reception modes as favourites on station buttons.

1. Set the desired station.
2. Open the station buttons.

3. Tap and hold the station button until the station is stored.

**Or:** tap and hold a station in the station list.

The station buttons are displayed.

4. Tap station button.

The station is stored to the selected station button.

If a station was already stored on the station button, this station will be removed from the station button and replaced by the new station. <

## **Special functions in radio mode**

 Please refer to  and  on page 234.

The special radio mode functions listed below are not available on all Infotainment systems, or in all countries, depending on the equipment.

### **TP (Traffic Programme)**

The TP function monitors the reports from a set traffic news station and automatically outputs them in radio mode or during media playback. Reception of a traffic news station must be possible for this.

Some stations that do not broadcast their own traffic news support the TP function through a corresponding traffic news station (EON).



The system will always automatically tune to a traffic news station in the background if one is available in the AM frequency band or media mode.

If no traffic news station can be received, No TP will be shown on the display. The unit automatically searches for a receivable traffic news station. As soon as a new traffic news station can be received, the status in the display changes to TP again.

The TP function must be activated in the settings in order to receive traffic announcements.

Traffic news stations are not available in all countries.

### **Switching on the TP function**

1. In radio or media mode, tap  or  and activate  Traffic Programme (TP).

### **Internet radio**

Internet Radio is a reception mode for internet radio stations and podcasts which is independent of AM, FM and DAB. Due to transmission via the internet, reception is not regionally restricted.

Internet radio is available only when the Infotainment system has an active internet connection.

Costs may be incurred for data transmission from the internet when using Internet Radio mode.

 In some countries, functioning of Internet Radio depends on the privacy settings in the vehicle.

### Station logos



Station logos may be pre-installed for some frequency bands in the Infotainment system.

The station logos will be assigned to the stations automatically if **Autoselect station logos** is activated in the settings.

In Internet Radio mode, the Infotainment system accesses station logos from an online database and automatically assigns them to the stations.

### Manually assigning station logos

You cannot assign station logos manually in the AM frequency band.

1. In radio mode, tap  **Station logos**.
2. Select the station to which you wish to assign a station logo.
3. Select station logo.
4. Repeat the process for further stations if desired.
5. Tap  to finish assigning station logos.

## Online functions in radio mode

 Please refer to  and  on page 234.

With some equipment levels, the Infotainment system has online functions in radio mode.

Online functions in radio mode are not available in all countries and vehicle models.

Internet Radio is an example of an online function in radio mode.

### Requirements for using online functions in radio mode:

- ✓ The vehicle is equipped with We Connect or We Connect Plus.
- ✓ You have an active We Connect user account.
- ✓ The vehicle is assigned to your We Connect user account.
- ✓ You have purchased a corresponding data plan for an internet connection from the In-Car Shop or you have available data volume on the SIM card of your mobile telephone and are connec-

ted to your vehicle via the WLAN hotspot on your mobile telephone → page 226. 

## Media mode

### Introduction to the topic

In media mode, you can play media files from data media on the Infotainment system.

With some equipment levels, the following data media can be used:

- USB data medium, e.g. USB stick.
- Bluetooth device, e.g. mobile telephone.
- SD map.





With some equipment levels, the following types of media files can be played back:

- Audio files, e.g. music.
- Video files.

### Streaming services

With some equipment levels and in some countries, you can also use streaming services → page 251.

### Open the MEDIA main menu

1. Tap **HOME**  .
- Or: tap **MENU**  .
- Or: tap **MEDIA**.

### Opening settings

1. Tap **MENU**   .
- Or: tap **MEDIA**  .
- Or: press **MEDIA** and tap .

### Restrictions and notes on data media

Dirty, overheated or damaged data media may be unusable. Observe the manufacturer's instructions.

Differences in the quality of data media from different manufacturers can interfere with media playback.

Incorrect configuration of a data medium can render it unreadable.

The read time of data media can be increased by the storage capacity, usage state (copying and deletion processes), file system, folder structure, and the amount of stored data.

Playlists simply specify a playback sequence. They link to the location of the media files within the folder structure. There are no media files stored in

a playlist. To play a playlist, the media files must exist in the locations on the data medium referenced by the playlist.

 No liability can be accepted for damaged, modified or lost files on data media.

## Equipment features and media symbols

 Please refer to  and  on page 234.

### Audio, media, connectivity

The available functions and possible media formats depend on the vehicle equipment and are not available in all countries.

The appearance of the symbols may differ depending on Infotainment system.

- Media playback and media control via Bluetooth.
- Audio playback in the following formats:
  - AAC.
  - APE.
  - ALAC.
  - FLAC.
  - MP2.
  - MP3.
  - MP4.
  - Vorbis.
  - OPUS.
  - WMA.
  - WAV.
- Video playback in the following formats:
  - MPEG-1 and MPEG-2 (.mpg, .mpeg, .mkv, .avi).
  - ISO MPEG-4 ASP; Xvid (.mp4, m4v, .mov, .mkv, .avi).
  - ISO MPEG-4 AVC / H.264 (.mp4, .m4v, .mov, .mkv, .avi).
  - Windows Media Video 9 (.wmv, .asf, .mkv, .avi).
- Cross-device playlists.
- Cross-source media database:
  - The data of all media sources connected to the Infotainment system is stored in a media database.
- Media streaming (online).
- Media search.

### Symbols for media sources

 Select **My media** as the media source. Connected USB devices can be selected under **My media**.

 Select a device connected via Bluetooth as media source.

 Set up available streaming services. Already set up streaming services will be displayed in the list of media sources with their own logo.

### General symbols in media operation

 Start playback.

 Pause playback.

 Go to previous track.

 Go to next track.

 Repeat current track.

 Repeat all tracks.

 Activate shuffle mode.

 Search current media source (list view).

 Close list view.

 Go back to higher-level folder of the media source.

 Show favourites list.

### Symbols for categories and groups of media files

 Music tracks.

 Videos.

 Playlists.



Albums.



Artists.



Genre.



Podcasts.



Audio books.

### Symbols for video playback



Play video in full-screen mode.



Minimise playback.

## Selecting and playing a media source

Please refer to  and  on page 234.

### Selecting a media source

1. Connect an external media source if you require playback from an external media source.
2. Select the connected media source that is to be used for playback.

### ▶ Playing audio and video files

Before playing media files you must first connect a media source.

You can search for and play media files from an available media source in various ways.

### ☰ Searching in the folder structure

All media files of USB devices are filtered according to categories, e.g. album. This category view is always displayed in My media. The classic folder structure of the individual USB data media is additionally located under My media.

1. Show folder structure.

The folder structure of the selected media source is displayed. If My media is selected, categories, e.g. music, and connected media sources are displayed first.

2. Search through the folder structure for the desired track.

**Or:** tap  to start the full-text search.

The input field is displayed.

3. Enter the name of the desired track.

The list of found tracks is automatically updated during input.

4. Tap the desired track.

If the selection is located in a folder on a media source at the start of playback, the media files located in this folder will be added for playback.

If a playlist is played, all available tracks in the playlist will be added for playback.

5. Close the selection with .

### ☆ Selecting favourites

You can save individual tracks, albums, artists and genres as favourites for playback.

1. Open favourites.
2. Tap the desired favourite.

Depending on the selected favourite, all tracks that belong to it are added to the playback content.

### ☆ Saving favourites

You can only store media files that are saved to My Media in the Music and Video folders as favourites. You can save individual tracks, albums, artists and genres.

1. Start playback.
2. Open favourites.
3. Tap a free favourite location.

**Or:** tap an already assigned favourite location and hold for around 3 seconds.

4. Choose from the selection list:

- Track.
- Albums.
- Artists.
- Genres.
- Playlists.

The selection is saved as a favourite at the selected favourite location. If the favourite location was already assigned, the previously stored favourite is overwritten.

The selection options in the selection list depend on the data attached to the media file. If no genre is specified for music files, for example, the genre cannot be saved as a favourite.

If a video file is currently being played, only this video can be saved as a favourite.

### Setting up streaming services

Depending on the vehicle equipment and country, you can use streaming services directly via the Infotainment system → page 248. You require an Internet connection in order to use streaming services → page 248.

1. Select **Media streaming** as the media source.  
A list of available streaming services is displayed.
2. Select the desired streaming service.  
Either an input field will be displayed for input of the login data, or instructions will be shown for registration with the provider.
3. Enter the login data of the desired user account and confirm.  
The streaming service is added to the list of media sources as a new function button.

 You may need to log in again to the streaming service if you change the privacy setting, for example.

## Entertainment playback via the Infotainment system

 Please refer to  and  on page 234.

You can play music and videos on the Infotainment system.

### Video mode

In video mode, the Infotainment system display can play a video from a data medium → page 250.

You can also play videos from streaming services, depending on the equipment and country → page 250.

The video soundtrack is played on the vehicle loudspeakers.

A stable Internet connection is required for playback via a streaming service. Costs may be charged by the mobile operator.

The video image is displayed only when the vehicle is stationary. When the vehicle is in motion, the Infotainment system display is switched off. The video audio can continue to be heard.

In some countries, no video image is displayed even when the vehicle is stationary for traffic safety reasons.

## Online functions in media mode

 Please refer to  and  on page 234.

With some equipment levels, the Infotainment system has online functions in media mode.

Online functions in media mode are not available in all countries and vehicle models.

Streaming services are one example of the online functions in media mode.

### Requirements for using online functions in media mode:

- ✓ We Connect or We Connect Plus is available in the vehicle.
- ✓ You have an active We Connect user account.
- ✓ The vehicle is assigned to your user account.
- ✓ You have purchased a corresponding data plan for an internet connection from the In-Car Shop or you have available data volume on the SIM card of your mobile telephone and are connected to your vehicle via the WLAN hotspot on your mobile telephone → page 226.

### Streaming services

You can additionally use streaming services, depending on the vehicle equipment.

Streaming services are not available in all countries and vehicle models.

### Conditions for using streaming services:

- ✓ The requirements for using online functions in media mode must be met.
- ✓ You have a user account for the respective streaming service:

 Some streaming services can only be activated or deactivated together, even if they are listed individually in the menu → page 220.

## Navigation

### Introduction to the topic

The current vehicle position is determined by means of a global satellite system. To enable optimal navigation to the destination, all readings and possible traffic messages are compared with the available map material

◀ Acoustic navigation announcements and visual guidance direct the driver to the destination.

In certain countries, some Infotainment system functions can no longer be selected when the vehicle is travelling above a certain speed. This is not a malfunction, but simply a legal requirement.

### **WARNING**

Configure the settings and enter destinations and changes for the navigation only when the vehicle is stationary.

 The navigation may recalculate the route if the driver misses a turning.

 The quality of the navigation recommendations depends on the navigation data available and any reported traffic jams.

 Traffic announcements will be output in the navigation system only if the available We Connect service has been activated.

### **Opening the main menu of the navigation system**

1. Tap **HOME** ▶ .  
Or: tap **MENU** ▶ .

### **Opening settings**

1. Tap **HOME** ▶  ▶ .  
Or: tap **MENU** ▶  ▶ .

### **Navigation announcements**

Navigation announcements are acoustic driving instructions for the current route.

The type and frequency of navigation announcements depends on the driving situation, e.g. start of route guidance, driving on a motorway or in a roundabout.

A navigation announcement informing you that you have reached the destination area is given if the exact destination cannot be reached, e.g. because it is located in a non-digitised area. In addition, information on the direction and distance to the destination are displayed on the screen.

During dynamic route guidance, you receive information about reported traffic jams on the route. An additional navigation announcement is given if the route is recalculated due to a traffic disruption or changed driving style → page 256.

The volume of a navigation announcement can be adjusted or muted during output of the announcement. All other navigation announcements are given with this volume setting or are muted.

 Navigation announcements are not given if the Infotainment system has been muted.

### **Restrictions during navigation**

When the Infotainment system cannot receive any data from GPS satellites, e.g. in a tunnel, navigation can still continue using the vehicle sensors.

In areas that are not or are not completely included in the Infotainment memory, the Infotainment system will also try to enable route guidance.

If navigation data is unavailable or incomplete, the navigation system may be unable to determine the exact vehicle position. As a result, the navigation may not be as exact as usual.

Road navigation is subject to continuous changes, e.g. new roads, road works, road closures, changes in the road names and house numbers. In the case of obsolete navigation data, there may be errors or inaccuracies during navigation.

### **Controlling the navigation map**

For optimal viewing, you can also operate the navigation map with advanced finger movements.

### **Moving the navigation map**

Recommendation: use your index finger.

1. Use your finger to move the navigation map.

### **Enlarging and reducing the map view**

Recommendation: use your index finger.

1. Tap the map twice in succession and keep your finger on the screen.
2. Move your finger upwards to zoom out from the map view. Move your finger downwards to zoom in on the map view.

### **Enlarging and reducing the map view**

Recommendation: use thumb and index finger.

1. Using two fingers at the same time, tap the map and keep your fingers on the screen.
2. Move your fingers together to zoom out from the map view. Move your fingers apart to zoom in on the map view.

### **Tilting the map view**

Recommendation: use your index and middle finger.

1. Using two fingers that are horizontal to each other at the same time, tap the map and keep your fingers on the screen.
2. Move your fingers upwards to tilt the map view forwards. Move your fingers downwards to tilt the map view backwards.

## Rotating the map view

Recommendation: use thumb and index finger.

1. Using two fingers at the same time, tap the map and keep your fingers on the screen.
2. Turn your fingers clockwise or anticlockwise to rotate the map view.

## Stored data

The Infotainment system stores certain data, e.g. frequently driven routes and positioning data, so that you can enter destinations quickly and enjoy the most efficient route guidance.

## Deleting stored data

1. Tap  ► Basic functions ► Delete usage pattern.
2. Tap confirmation to delete.

## Navigation equipment and symbols

 Please refer to  and  on page 234 and  at the start of the chapter on page 251.

### Navigation

The navigation equipment, symbols and functions depend on the equipment and are not available in all countries.

### Equipment

- Destination input and route calculation.
- Simultaneous display of two navigation maps (screen and instrument cluster).
- Personal POIs.
- 3D City Maps.
- Online Map Update.
- Online Traffic Information.

### Map symbols

The function buttons and displays depend on the settings and the current driving situation.

The map displays symbols for traffic announcements and POIs, such as filling stations, if the navigation data is available → page 257.

 Display current position.

 Destination search.

 Destinations and stopovers on the current route.

 Personal destination suggestions (home address, work address, favourite POIs nearby).

 Display route options.

 Fully automatic map mode (alignment in direction of travel, position, zoom and tilt).

 Determine driving orientation and map tilt.

 Map scale.

 Display destination memory.

 Display additional window with further options. Map menu with settings for navigation and navigation announcements.

### Symbols in the additional window

– To open the additional window, tap .

 Display route overview and alternative routes for current route guidance.

 Repeat the previous navigation announcement.

 Mute navigation announcements and adjust volume for navigation announcements.

 Navigation setup.

### Other symbols

 Destination search: detailed destination input for an address.

### Route plan symbols

 Display current position.

 Destination of the current route guidance.

 End the current route guidance.

 Close the route plan.

## Setting preferred POI categories

The system offers various POIs, e.g. filling stations, as quick selection symbols in destination input, in the route plan and on the map. You can prioritise display of these symbols under  ► **Basic function settings** ► **Preferred POI categories**. The system also independently learns which category you prefer.

## Traffic reports

Traffic announcements are displayed on the map when navigation data is available → page 257.

Tap a traffic announcement to open an additional window with further details → page 256.



Traffic jam.



Accident.



Ice.



Road closed.



Risk of skidding.



Danger.



Road works.



Strong winds.

## Navigation data

 Please refer to  and  on page 234 and  at the start of the chapter on page 251.

The Infotainment system has an internal navigation data memory. Depending on the country, the required navigation data is already pre-installed.

In order to carry out route guidance correctly and make full use of the functions offered, the Infotainment system always requires up-to-date navigation data.

## NOTICE

If you use obsolete data, navigation may be impaired. Current routes cannot be determined or route guidance leads to the wrong destination.

- Always keep navigation data up-to-date.

## Updating navigation data online

The navigation data for regions in which you regularly travel is automatically updated in the background when the ignition is switched on, an Internet connection is available and, depending on country, when the privacy settings are valid → page 222.

1. Switch on the ignition.
2. Check the Internet connection and, depending on the country, also check that privacy settings are valid. If necessary, connect to the Internet and select a mode other than "Offline" → page 222.

Navigation data for regions in which you regularly travel is automatically updated in the background.



Automatic updating of navigation data is country-dependent and also depends on the privacy settings. No update is carried out in offline mode → page 222.

## Updating navigation data manually

Current navigation data for larger regions, e.g. Western Europe, can be downloaded from the Internet at [www.volkswagen.com](http://www.volkswagen.com) and stored on a suitable USB data medium available commercially. If you switch off the Infotainment system, installation will be interrupted and will automatically continue once the unit is switched on again.

1. Download the navigation data and save on a USB data medium.
2. Switch on the vehicle ignition.
3. Connect a USB data storage device to the Infotainment system when the vehicle is stationary.

The navigation data for regions that are currently frequently travelled is automatically updated in the background.



No message appears in the Infotainment system while the navigation data is being updated, or once the update is complete.



When you update navigation data manually, the USB data medium must remain continuously connected. No message appears to indicate that the update has been completed.



Leave the USB data storage device connected to the Infotainment system for a few days un-



til the navigation data for travelled regions has been completely downloaded and installed. Installation takes place automatically in the background while driving. Failure to do so will cancel the update. If you remove the data medium and travel through a new region in offline mode, the navigation data will not be updated, as there is neither a USBdata storage device nor an Internet connection.

### Displaying map data version

1. Tap **(MENU)**   System information.

## Entering a destination and starting route guidance

 Please refer to  and  on page 234 and  at the start of the chapter on page 251.

Depending on country and vehicle equipment, different functions are available for destination input.

Further information about the symbols on the Infotainment system display is available on → page 253.

You can more precisely limit the search by indicating preferences in the results list, such as "nearby".

The different functions for destination input can be found in the main menu of the navigation system.

### Opening the main menu of the navigation system

1. Tap **(MENU)** .

### Opening settings

1. Tap **(MENU)**   .

### Entering an address

Start route guidance by entering an address. The navigation system will suggest known destinations during input. You can also enter a new, as yet unknown address for route guidance.

 When entering the address, enter the name of the destination rather than the postcode.

### Selecting a destination and starting navigation

1. Tap **Q**.
2. Enter the address of the destination and select the desired destination.

Or: tap  and enter the address on the input screen.

3. Tap **Route**.

### Quick start

1. Tap **Q**.

2. Enter the address of the destination and tap and hold the desired destination for a few seconds.

 Enter the destination as accurately as possible. If you make a mistake when entering the destination, route guidance will not be possible or you may be navigated to the wrong destination.

### Recommended destinations

The navigation system uses stored data such as the last and learned destinations, favourites, and home and work addresses so it can use this data for route guidance.

### Selecting a destination and starting navigation

1. Tap .
2. Tap the desired destination.  
Route guidance starts automatically.

### Last destinations

The navigation system stores up to ten destinations that you have driven to last in order to make them available for route guidance. A new destination automatically overwrites the oldest destination.

### Selecting a destination and starting navigation

1. Tap .
2. Tap the desired destination.
3. Tap **Route**.

### Quick start

1. Tap .
2. Tap the desired destination and hold for a few seconds.

### Favourite destinations

Save up to 50 destinations as favourites.

### Saving a destination as a favourite

1. When entering a destination, tap  in the additional window.

### Selecting a destination and starting navigation

1. Tap .
2. Tap the desired destination.
3. Tap **Route**.

### Quick start

1. Tap .
2. Tap the desired destination and hold for a few seconds.

## Selecting on the map

The navigation map contains active areas at many locations which are suitable for destination input. To enter a destination, tap the desired position or location on the map. You can start route guidance if map data is available at this location.

Destination input via the navigation map depends on the data status and is not possible for all positions.

Use the offroad navigation function to enter a destination point with unknown data.

## Offroad navigation

The offroad navigation function calculates routes to selected destination points with unknown data. If a destination point is not on known roads or there is no positioning data available for this point, the navigation system will calculate the route up to the nearest point on the known roads and then complete the route up to the destination point by a direct connection.

To start offroad navigation, tap a free area without positioning data.



## Starting navigation

1. Tap .
2. Move the map view until the desired position can be selected. The navigation map can be operated by extended tap gestures → page 251.
3. Tap the desired destination or any destination point on the map without positioning data.
4. Tap **Route**.

## Using the address data of a contact

Start navigation using the stored address data of a contact. Stored contacts without address data cannot be used for route guidance.

## Starting navigation

1. Tap  .
2. Tap the desired contact and address data.
3. Tap **Route**.

## NOTICE

If the address data of a contact is out-of-date, navigation will still be performed to the stored address. Make sure that the address of the contact is up-to-date.

## Function descriptions

 Please refer to  and  on page 234 and  at the start of the chapter on page 251.

## Route plan

The route plan contains information on relevant events, such as stopovers and suggested destinations, if navigation data is available.

When you tap an event, an additional window opens with further options. The options available depend on the event and the current settings → page 251.

## Opening and closing the route plan

1. Tap the route plan to open the route plan.
2. Tap **>** to stop route guidance.

## Editing route guidance

To edit route guidance, move the stopovers or the destination to the route plan.

1. Tap and hold the desired destination until it is visibly highlighted.
2. Move the destination to the desired position and release.

The route will be recalculated.

## Bypassing a traffic disruption

The route plan displays reports of current traffic disruptions when navigation data is available. Avoid traffic disruptions by editing the route plan → page 257.

1. Tap the traffic announcement.
2. Tap **Bypass**.

The route will be recalculated.

 For each guidance to a destination, only one announced traffic event can be avoided in this way.

## Additional window on the route plan

If you tap the entries of the route plan, an extra window with additional options can appear. The possible options depend on the entry touched.

## Functions in the additional window:

 **Display on map** Display the selection on the map.

 **Add stopover** Add a stopover to the route guidance.

 **Direct route** Start direct route guidance.

 **Delete** Delete stopover from route guidance.

 **Bypass** Avoid a traffic disruption. The route will be recalculated.

 **Stop route guidance** End the current route guidance.

### Closing the additional window on the route plan

1. Tap a free area outside the additional window.

### Learning usage patterns

While travelling, the navigation saves the routes travelled and destinations arrived at in order to create suggested destinations automatically. Destinations are learned depending on the time of day and the day of the week.

The navigation system can suggest learned routes.

1. To display the suggested routes, tap .

Route guidance begins when one of the suggested routes is selected.

The route guidance follows the selected route until the vehicle deviates from it. The route is recalculated and will guide you back to the selected route via a direct alternative.



Major traffic disruptions are taken into account in the route guidance. Major traffic disruptions will be avoided if an alternative route and the navigation data is available.

If you drive an already learned route when route guidance is inactive, the destination will be transferred to the route plan. It is not necessary to actively start route guidance to the learned destination. Warnings may be given about traffic disruptions.

A forecast arrival time will be displayed.

You can activate or deactivate the function at any time and also delete the stored data for the function.

### Activating and deactivating "Learn usage pattern"

1. Tap   **Basic function settings** to open the settings for this function.
2. Tap **Learn usage pattern** to activate or deactivate the function.
3. Tap **Delete usage pattern** to delete saved data.

## Traffic information

 Please refer to  and  on page 234 and  at the start of the chapter on page 251.

Depending on equipment, reception of traffic information is not available in all Infotainment systems and not in all countries.

The Infotainment system automatically receives detailed traffic information when connected to the Internet. This information is indicated by symbols and colouring of the road network on the map.

 Receipt of traffic information depends on the privacy settings. No traffic information is received in offline mode → page 221.

### Traffic reports

Traffic announcements, e.g. traffic jams or slow-moving traffic are shown as symbols on the navigation map → page 253.

When route guidance is active, traffic reports that are on the current route are displayed in the route plan. You can bypass these traffic reports → page 256.

 Local warnings, e.g. about severe weather, can be output as a pop-up message via the Infotainment system.

### Traffic flow display

The traffic flow is shown on the navigation map for all traffic reports by colouring of the road network.

**Orange** Slow-moving traffic.

**Red** Traffic jam.

## Mobile phone interface

### Introduction to the topic

You can connect your mobile telephone to the Infotainment system via the mobile phone interface and then use the Infotainment system to control the telephone functions. Sound is played back using the via the vehicle loudspeakers.

You can connect up to two mobile telephones to the Infotainment system simultaneously. Only one device is active and can be used to make calls. You can use the second connected device to receive calls via the Infotainment system and for media playback.

High speeds, poor weather and poor road conditions, loud noise levels, also outside the vehicle, and network quality may impair telephone calls in the vehicle.



The mobile phone interface may contain an aerial amplifier which improves the reception quality of the mobile telephone.

 As a general rule, it is only necessary to pair a device, e.g. mobile telephone, once. The device connection with the Infotainment system via Bluetooth or WLAN can be restored at any time without having to pair the device again.

 When a telephone call is made using the hands-free system or at a loud volume, a con-

versation can also be heard by third parties outside the vehicle.

### Open the menu for the mobile phone interface

1. Tap **[HOME]** ▶ .  
Or: tap **[MENU]** ▶ .  
Or: press **[PHONE]**.

## Equipment and symbols of the mobile phone interface

 Please refer to  and  on page 234.





The specified equipment features and symbols are not available in all countries and for all Infotainment systems.

### Equipment features

- Hands-free function.
- Use up to two mobile telephones simultaneously.
- Phone book with up to 5,000 contact entries.
- SMS functions via Bluetooth:
  - Read SMS.
  - Write SMS (including templates).
  - Have SMS read out loud.
  - Message history.
- Email functions via Bluetooth:
  - Read emails.
  - Write emails.
- Convenience telephony.
- Connection to wireless charging facility (wireless charging function) → page 260.
- Connection to microphone installed in the vehicle.

### Symbols in the main menu

The appearance of the symbols may differ depending on Infotainment system.















-  Contacts.
-  Call lists for incoming and outgoing calls.
-  Dial phone number.
-  Text messages (SMS and email).

 Change active device.

 Settings of mobile phone interface.

### Symbols for phone calls

◀ The appearance of the symbols may differ depending on Infotainment system.

-  Make or answer and display call.
  -  End or reject call.
  -  Mute hands-free system.
  -  Hold call.
  -  Continue call.
  -  Add a participant to a conference or start conference.
  -  Make emergency call (SOS).
  -  Obtain help in the event of breakdown.
  -  Voicemail.
  -  Obtain information about the Volkswagen brand and selected value-added services relating to traffic and travel.
- ### Symbols for call lists
1. Tap  to open the call lists.
-  Incoming call.
  -  Outgoing call.
  -  Missed call.
  -  Frequent calls or favourites from the mobile telephone (if supported by the mobile telephone).



Phone number (work).



Phone number (private).



Mobile number.



Fax.



Fax (business).



Fax (private).

### Symbols for text messages

The appearance of the symbols may differ depending on Infotainment system.

1. Tap  to open the text messages.



Template for text messages.



Have text messages read out loud.

## Areas where special regulations apply

 Please refer to  and  on page 234.

Switch off the mobile telephone and mobile phone interface in areas where there is an explosion hazard. These areas are not always clearly signposted. This includes, for example:

- Areas immediately around chemical pipelines and tanks.
- Lower decks of ships and ferries.
- The area around vehicles which run on liquid gas, such as propane or butane.
- Places where there are chemicals or particles such as flour, dust and metal powder in the air.
- All other places where the engine or mobile telephone must be switched off.

### WARNING

Switch the mobile telephone and mobile phone interface off in potentially explosive areas and locations where special guidelines apply.

### NOTICE

Your mobile telephone must always be switched off in areas where special regulations apply and when the use of mobile telephones is forbidden. The radiation produced by the mobile telephone when switched on may interfere with sensitive technical and medical equipment, possibly resulting in malfunction or damage to the equipment.

## Types of mobile phone interface

 Please refer to  and  on page 234.

Depending on country and vehicle equipment, the following mobile phone interface types may be present in your vehicle:

- Basic equipment of the mobile phone interface.
- Comfort mobile phone interface.

### Basic equipment of the mobile phone interface

The mobile phone interface uses the HFP Bluetooth profile for transmission. This allows use of telephone functions via the Infotainment system and output via the vehicle speakers.

### Comfort mobile phone interface

The Comfort mobile phone interface uses the HFPBluetooth profile like the basic version of the mobile phone interface.

The Comfort mobile phone interface may be equipped with a wireless charging function → page 260.

In order to use the wireless charging function, you must place a suitable mobile telephone correctly in the stowage compartment. Depending on equipment, the mobile telephone is paired with the vehicle aerial. This improves the reception and call quality.

## Wireless charging function

📖 Please refer to ⚠ and ① on page 234.

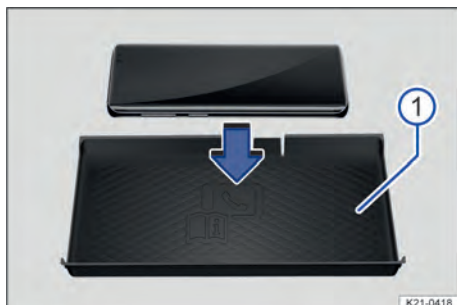

**Fig. 178** Illustration: stowage area with mat for wireless charging function.

The wireless charging function is dependent on the equipment level and is not available in all countries.

The stowage area with lining mat → Fig. 178 ① for the wireless charging function is located either in the centre console or in a stowage compartment in the area between the front seats depending on the vehicle.

In some vehicles, the lining mat → Fig. 178 ① has a telephone symbol that marks the centre position of the wireless charging function. The symbol on the lining mat may look different in some vehicles.

The wireless charging function enables wireless energy transmission by electromagnetic induction over a short distance.

The maximum charging power is 5 watts.

The Qi standard enables wireless charging of suitable Qi-enabled mobile telephones.

Consult the operating manual for the mobile telephone to find out if it is compatible with the Qi standard. The manufacturer of the mobile telephone can provide more information on compatibility.

Always place only one Qi-enabled mobile telephone without a protective case and with maximum dimensions (width x length) of 80 mm x 140 mm (approx. 3 in x 6 in) flat on the shelf for the wireless charging function.

Qi-capable mobile telephones with larger dimensions cannot be charged wirelessly.

Before charging, remove any foreign objects with metallic components such as coins from the stowage compartment and observe the operating instructions for the mobile telephone.

To charge a Qi-enabled mobile telephone, remove the protective cover and place the entire surface of the suitable mobile telephone flat in the centre of the stowage area with the display facing upwards. The charging process starts automatically.

The factory-fitted Infotainment system will provide information about the start of the charging operation and, where applicable, about any foreign objects with metallic components that are detected in the stowage compartment. Remove foreign objects immediately!

If the mobile telephone has not been positioned correctly in the stowage area or is too large, it cannot be detected or cannot be detected correctly. In certain circumstances, the Infotainment system will report that there is a foreign object in the stowage compartment. The fault can be rectified if a suitable mobile telephone is used and its position is corrected.

### ⚠ WARNING

Metallic objects may become very hot. This may cause burn injuries to the skin and cause a fire.

- Do not place any metal or metallic objects on the shelf for the wireless charging function.

### ⓘ NOTICE

Do not place any ID cards, credit cards etc. with magnetic strips or a chip on the shelf for the wireless charging function. The data saved on the magnetic strip or on the chip may become unusable. ◀

## Pairing, connecting and managing

📖 Please refer to ⚠ and ① on page 234.

Pair a mobile telephone with the Infotainment system to use the functions of the mobile phone interface. The mobile telephone must be paired with the Infotainment system before the first connection is established. A user profile is then automatically stored in the Infotainment system.

The pairing process can take a few minutes. The available functions depend on the mobile telephone used and its operating system.

### Pairing a mobile telephone

Prerequisites for pairing:

- ✓ Bluetooth is activated on the mobile telephone.
- ✓ Bluetooth is activated in the Infotainment system.

1. Open the list of available Bluetooth devices on the mobile telephone and select the device name of the Infotainment system.

2. Observe the messages on the mobile telephone and Infotainment system and confirm as necessary.

If pairing was successful, the data of the mobile telephone will be stored in the user profile.

3. Optional: confirm the data transfer prompt on the mobile telephone.

### WARNING

If you carry out pairing when driving, this can cause accidents or injuries.

- Carry out pairing only when the vehicle is stationary.

 When some mobile telephones are paired, a PIN is shown on the display of the mobile telephone. To finish the pairing procedure, enter this PIN on the Infotainment system.

### Active and passive connection

At least one mobile telephone must be connected to the Infotainment system in order to use the functions of the mobile phone interface. If several mobile telephones are connected to the Infotainment system, you can switch between active and passive connections. Establish an active connection to the Infotainment system in order to operate the mobile phone interface with the desired mobile telephone.

### Difference between the connection types

**Active** Mobile telephone is paired and connected. The functions of the mobile phone interface are performed with the data of this mobile telephone.

**Passive** Mobile telephone is paired and connected. Only incoming calls can be accepted via the mobile phone interface. No other functions are available.

Paired mobile telephones are stored in the Infotainment system even if they are not currently connected.

### Connecting a mobile telephone

Prerequisite: a mobile telephone is paired with the Infotainment system.

1. Activate Bluetooth on the mobile telephone.

### Changing the connection type (passive to active)

Prerequisite: several mobile telephones are connected to the Infotainment system simultaneously.

1. Tap .

**Or:** tap the name of the active mobile telephone.

The mobile telephone with an active connection is highlighted.

2. Select the name of the desired mobile telephone.

Other mobile telephones then automatically have a passive connection.

### User profiles

An individual user profile is automatically created for every paired mobile telephone. Data from the mobile telephone is stored in the user profile, e.g. contact details or settings. A maximum of ten user profiles can be stored in the Infotainment system simultaneously.

To completely delete the stored data, reset the Infotainment system to the factory settings. 

## Making phone calls and sending messages

 Please refer to  and  on page 234.

### Opening the mobile phone interface

1. Tap  .  
**Or:** press .

### Using the telephone

Select a telephone number to start the call. Different functions are available for selection of phone numbers.

### Using contact data

If there are several phone numbers for each contact, you must select the phone number you require.

1. Tap . Tap a contact in the list to start the call.



**Or:** tap . To search for a contact, enter the name of the contact in the input field. Tap the contact to start the call.

**Or:** tap a favourite in the main menu of the mobile phone interface to start the call.

 When searching for a contact, enter the surname and first name separated by a space.



### Using the call list

The mobile phone interface displays the call list of the mobile telephone. Start calls via the call list.

1. Tap   All. Tap a number in the list to start the call.

Or: tap  and filter entries in the call list, e.g. missed calls or dialled numbers. Tap a number in the filtered list to start the call.

### Entering a phone number manually

1. Tap  and enter telephone number.
2. Tap  to start the call.

 While you are entering a phone number, contacts that match the number will be shown on the Infotainment system display.

### Sending text messages

Depending on the mobile telephone and the Infotainment system being used, you can send and receive SMS messages and emails via the mobile phone interface in some countries.

### Sending text messages

1. Tap  ► Text message ► New message and enter the message on the screen.
2. Enter the desired contact in the search bar.
3. Tap OK to send the message.

### Sending emails

1. Tap  ► E-mail ► New message and enter the message on the screen.
2. Enter the desired contact in the search bar.
3. Tap OK to send the message.

## Telephone book, favourites and speed dial buttons

 Please refer to  and  on page 234.

### Telephone book

The telephone book is stored in the Infotainment system when a mobile telephone is paired with the Infotainment system for the first time. It may be necessary to confirm transfer on the mobile telephone.

The telephone book is updated each time a new connection is established. The still existing telephone book can be used during the update.

If conference calls are supported, the telephone book can be opened during a call and a further participant added to the call.

If an image is stored for a contact, this can also be displayed in the list next to the entry.

The appearance of the symbols may differ depending on Infotainment system.

### Favourites and speed dial buttons

A favourite from the telephone book can be assigned to a speed dial button. If an image is stored in the entry, it will be displayed on the speed dial button.

Speed dial buttons must be assigned manually and are assigned to a user profile → page 260.

### Assigning a speed dial button

1. Tap a free speed dial button.
2. Tap a contact from the telephone book or search for the contact using the search bar. If several phone numbers are stored for a contact, tap a number from the list.

### Editing a speed dial button

1. Tap and hold the speed dial button until the telephone book is opened.
2. Tap a new contact from the telephone book. If several phone numbers are stored for a contact, tap a number from the list.







### Calling a favourite

1. Tap the assigned speed dial button.

 Favourites are not automatically updated. If the phone number of a contact changes, the speed dial button must be assigned again.



### Deleting favourites from the speed dial button

1. Tap  ►  ► Manage favourites.  
Tap  on the desired speed dial button to delete a favourite.  
Or: tap  ► .  
Or: tap Delete all to delete all favourites from all speed dial buttons.
2. Tap confirmation to delete. 

## Voice control

### Introduction to voice control

The voice control allows you to perform certain functions by spoken commands.





## Types of voice control

Depending on the language set in the Infotainment system, one of the following voice control types is available in the vehicle:

- Command-based voice control (standard).
- Advanced voice control (offline or online).

### Does my vehicle have voice control?

Voice control is installed in the vehicle if the voice control button  is present on the multifunction steering wheel or the  button is present on the Infotainment system, or if your vehicle understands the activation word.



In black with blue background: voice control is active and will recognise spoken words.



Test voice control before starting a journey in order to familiarise yourself with the function. <

## Differences in voice control systems

### Command-based voice control (standard)

Only grammatically correct voice commands will be recognised by the voice control. Voice commands must follow a defined syntax in order to be recognised correctly, e.g.: "Navigate to [Town, Street name, House number]". You will find further examples in the Infotainment system. Command-based voice control can be performed in every available language.

### Advanced voice control (offline or online)

Voice commands can be freely formulated and colloquial. For example, the system will show the remaining time until arrival at your destination in response to the statement "How much longer do I have to drive?" Suggestions for voice commands depend on the set language and can be found in the Infotainment system.

Advanced voice control works online and offline. Voice commands can be processed better in online mode because more data is available. For online mode, you need a valid We Connect Plus or We Connect Start contract.



If advanced voice control is available for your language, this will be used when voice control is activated.

### Supported languages

The number of languages available in your country depends on the vehicle equipment.

Start voice control by speaking the activation word available in your country → page 264. <

## Starting and stopping voice control

### Voice commands

Voice control recognises only voice commands in the language set in the Infotainment system.

Observe the following tips for successful voice commands:

- ✓ Speak clearly and at normal volume. Speak slightly louder at higher speeds.
- ✓ Avoid excessive emphasis or strong dialect.
- ✓ Do not leave long pauses when speaking.
- ✓ Avoid exterior and background noise.
- ✓ Do not point the airflow from the vents towards the microphones or roof.

### Opening suggested voice commands



1. Tap  ►  ► .





Depending on the content of the telephone book, it may be advisable to swap the order of the contact's forename and surname to ensure it is reliably recognised from the telephone book.

### Starting the voice control function

Depending on the vehicle equipment, you can start voice control using different methods:





- *Starting with voice:* speak the activation word.
- *Starting via multifunction steering wheel:* Press the voice control button .
- *Starting via the Infotainment system:* tap .



Depending on the mobile telephone and operating system, voice control of a connected mobile telephone can be started by pressing and holding  or the .

### Ending the voice control function

Depending on the vehicle equipment, you can end voice control in different ways:

- *Ending with voice:* to open suggestions for a voice command for ending voice control, tap  ►  ►  ► **General**.
- *Ending with multifunction steering wheel:* Press the voice control button .
- *Ending automatically:* voice control is ended automatically if you use functions in the Infotainment system, activate the parking system, tele-

phone calls are received or if there are voice outputs and warnings from the navigation system. <

## Activation word

The words spoken in the vehicle are checked for the activation word in the Infotainment system circular buffer. Voice control starts if the Infotainment system recognises the activation word. The circular buffer is overwritten approximately every 15 seconds. There is no transmission of data or words spoken in the vehicle. The circular buffer is not active if the activation word is deactivated.

### Switching activation word on and off

If the activation word is switched off, the voice control cannot be activated via the activation word.

1. Tap **MENU** ►  ► Voice control ► Voice control start/end sound or Activation word.

### Speaking activation word and activation word recognition

Prerequisite:

- ✓ The Activation word is switched on in the settings.

**BG** Здравей Volkswagen.

**BR** Olá Volkswagen.

**CDN** Bonjour Volkswagen.

**CZ** Ahoj Volkswagen.

**D** Hallo Volkswagen.

**DK** Hej Volkswagen.

**E** Hola Volkswagen.

**F** Bonjour Volkswagen.

**FIN** Hei Volkswagen.

**GB** Hello Volkswagen.

**GR** Γεια σου Volkswagen.

**I** Ciao Volkswagen.

**J** こんにちは Volkswagen.

**MEX** Hola Volkswagen.

**N** Hallo Volkswagen.

**NL** Hallo Volkswagen.

**P** Olá Volkswagen.

**PL** Cześć Volkswagen.

**ROK** 안녕하세요 Volkswagen.

**RUS** Привет Volkswagen.

**S** Hej Volkswagen.

**TR** Merhaba Volkswagen.

**USA** Hello Volkswagen. <

## Troubleshooting

### Voice control does not react

- Voice control is not available in your language.
- Set the correct system language in the Infotainment system.
- Start voice control using the activation word or the voice control button on the multifunction steering wheel.
- Voice commands are not recognised due to a system error. Please contact a suitably qualified workshop. Volkswagen recommends using a Volkswagen dealership.

### **Voice control provides inappropriate answers**

- The voice control system has interpreted the question incorrectly.
- Speak the voice command again clearly.

### **Voice control does not perform function**

- The function cannot be performed by voice control.
- The function cannot be performed in all languages. Suggestions for voice commands in the set language can be found in the Infotainment system.
- Settings in the function prevent it from being switched on or performed.
- The voice control system has not understood the voice command.
- Insufficient data is available. <

# Transporting items

## Stowing luggage and loads

### Stowing luggage safely in the vehicle

- Always distribute any loads in the vehicle as evenly as possible. Do not cover any ventilation openings.
- Always stow luggage and heavy objects in the luggage compartment →  and place them as far forwards as possible.
- Observe gross axle weight ratings and the gross vehicle weight rating → page 388.
- Secure luggage to the fastening rings in the luggage compartment using suitable lashing, fixing and securing straps → page 270.
- Also stow small objects safely.
- If necessary, fold back the rear seat backrest and engage it securely.
- If necessary, adjust the headlight range. Vehicles with dynamic headlight range control adapt automatically to the load.
- Adjust the tyre pressure according to the vehicle load. Observe the tyre pressure sticker → page 334.
- If necessary, adapt the tyre monitoring system to the new load level → page 326.

### WARNING

Objects or animals that are not secured, or are secured incorrectly, can cause serious injuries in the event of a sudden driving or braking manoeuvre or accident. This applies particularly if objects are struck when the airbag is triggered and then flung through the vehicle interior. To reduce the risk of accidents, please observe the following guidelines:

- Always stow all objects in the vehicle securely. Observe legal requirements when doing this.
- Stow items in the vehicle interior in such a way that they can never enter the airbag deployment zones while the vehicle is in motion.
- Secure animals in the vehicle using a system that is suitable for their weight and size.
- Always keep stowage compartments closed while the vehicle is in motion.
- Stowed objects must never cause passengers to assume an incorrect sitting position.
- If an item is being stowed on a seat, this seat must not be used by any passengers.

- Do not stow any hard, heavy or sharp objects loose in any of the vehicle's open stowage areas, on the surface behind the rear seat backrest or on the dash panel.
- Remove any hard, heavy or sharp objects from items of clothing and bags inside the vehicle and stow them securely in the luggage compartment.

### WARNING

Transporting heavy objects changes the vehicle's handling due to the change in the centre of gravity and increases the braking distance. Heavy loads that are not properly stowed or secured in the vehicle can lead to a loss of vehicle control and can cause serious injury.

- Never overload the vehicle. Both the load and the distribution of the load in the vehicle will have an effect on the driving response and braking distance of the vehicle.
- Transporting heavy objects changes the vehicle's handling and the centre of gravity.
- Always distribute the load evenly and as low down as possible in the vehicle.
- Always stow heavy items in the luggage compartment as far as possible in front of the rear axle.
- Loose objects in the luggage compartment can suddenly slide and change the way the vehicle handles.
- Always adapt your speed and driving style to the current visibility, weather and road or traffic conditions.
- Accelerate particularly carefully and gently.
- Avoid sudden braking and driving manoeuvres.
- Brake earlier than usual.

### NOTICE

Rubbing objects on the rear windows can cause damage (e.g. to the heating wires of the rear window heating).

### NOTICE

Do not secure any luggage carriers or other carrier systems such as bicycle carriers on the vehicle's rear spoiler. 

## Luggage compartment cover

### Luggage compartment cover

When the boot lid is opened and closed, the luggage compartment cover is also raised and lowered if the retaining straps are attached.

The luggage compartment cover is not suitable as a shelf for objects, not even for light pieces of clothing → ⚠.

### ⚠ WARNING

Objects or animals on the luggage compartment cover can damage the luggage compartment cover and cause serious injuries in the event of sudden driving and braking manoeuvres or accidents.

- Never transport any objects on the luggage compartment cover.
- Never transport any animals on the luggage compartment cover.

### ⓘ NOTICE

Incorrect handling of the luggage compartment cover may result in damage.

- Do not load the luggage compartment to such a height that the luggage compartment cover can press on the load when the boot lid is closed.
- Never close the boot lid when the luggage compartment floor is open or locked in position.

### Installing and removing the luggage compartment cover

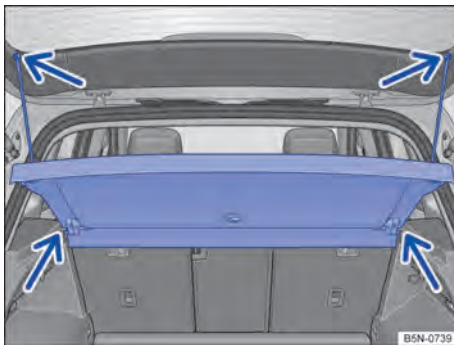

**Fig. 179** In the luggage compartment: removing and installing the luggage compartment cover.

### Removing the luggage compartment cover

1. Unhook the retaining straps at the top on the boot lid → Fig. 179 (upper arrows).
2. Lift the boot lid.
3. Press the luggage compartment cover out of the side holders in the luggage compartment → Fig. 179 (lower arrows).

### Fitting the luggage compartment cover

1. Push the luggage compartment cover into the side holders in the luggage compartment → Fig. 179 (lower arrows).
2. Hook the retaining straps onto the boot lid → Fig. 179 (upper arrows).

### Stowing the luggage compartment cover

Depending on the equipment level, the removed luggage compartment cover can be stowed under the variable luggage compartment floor. The luggage compartment cover must be turned over to do this.

## Luggage compartment floor

### Variable luggage compartment floor

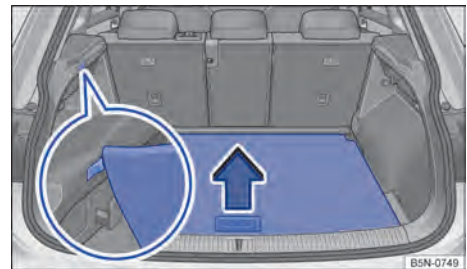

**Fig. 180** In the luggage compartment: raising the luggage compartment floor.

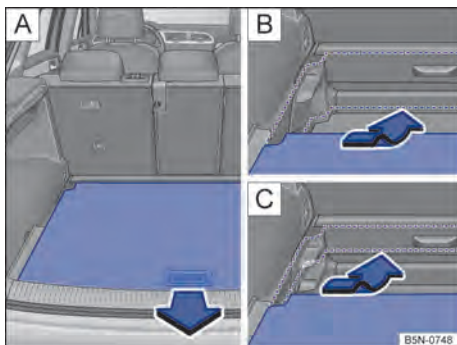

**Fig. 181** In the luggage compartment: adjusting the height of the luggage compartment floor.

### Opening the luggage compartment floor

1. Grasp the handle recess in the luggage compartment floor → Fig. 180 and fold the floor upwards in the direction of the arrow until it is held in position by the side restraints (close-up) → Fig. 180.

### Closing the luggage compartment floor

1. Guide the luggage compartment floor downwards into position → ①.

### Adjusting the height of the luggage compartment floor

Depending on the equipment level, the luggage compartment floor is height-adjustable.

1. If necessary, remove the luggage net → page 270 and also remove the retaining or securing straps.
2. Lift the luggage compartment floor and pull it rearwards out of the guides on the sides of the luggage compartment → Fig. 181 [A].
3. Insert the luggage compartment floor into the guides at the required height and push it forwards as far as it will go → Fig. 181 [B], [C].

### NOTICE

Incorrect use can damage the variable luggage compartment floor or the trim of the luggage compartment.

- Always guide the luggage compartment floor down carefully when closing and do not allow it to drop.

Depending on the vehicle equipment, there may be compartments for stowing small items under the luggage compartment floor.

Volkswagen recommends that you secure items to the fastening rings with the aid of fixing or securing straps.

## Net partition

### Folding the net partition in and out

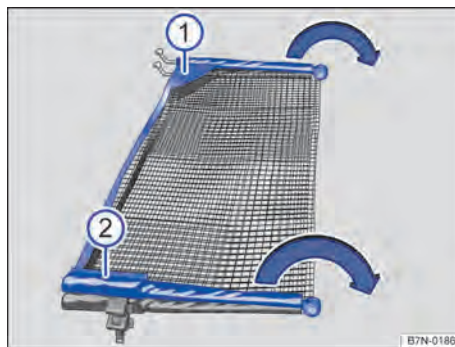

**Fig. 182** Folding out the net partition.

- ① Transverse rod.
- ② Transverse rod.

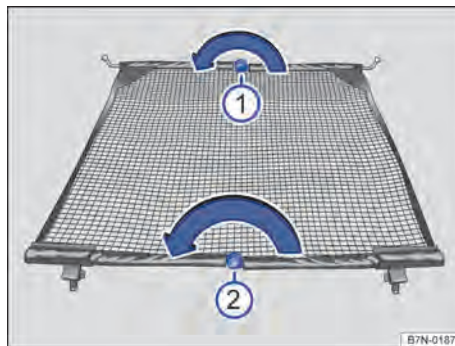

**Fig. 183** Folding in the net partition.

- ① Release button.
- ② Release button.

The net partition must be folded out before being fitted in the vehicle.

### Folding out the net partition

1. Remove the net partition from the bag and unroll.

- Fully fold out the net partition transverse rods → Fig. 182 ① and ② in the direction of the arrow until there is an audible click.

#### Folding in the net partition

- Press the release button and fold in the transverse rod in the direction of the arrow while keeping the release button pressed → Fig. 183 ①.
- Repeat this procedure with the other release button → Fig. 183 ②.
- Roll up the net partition and stow in the bag.
- Stow the bag safely in the vehicle.

## Installing and removing the net partition

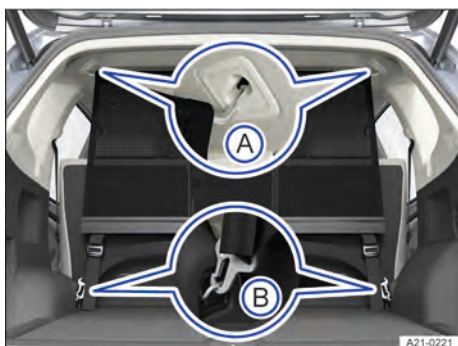

**Fig. 184** In luggage compartment: fitting net partition behind the rear bench seat.

- Ⓐ Mountings in the roof.
- Ⓑ Fastening rings for attaching the retaining hooks.

The net partition can help to prevent objects from being flung from the luggage compartment into the vehicle interior, e.g. in the event of a sudden braking manoeuvre.

#### Installing the net partition

The net partition can be fitted behind the rear bench seat or behind the front seats when the second row of seats are folded down, depending on the equipment.

- Remove the luggage compartment cover, if necessary → page 267.
- Fold out the net partition → page 268.

- Hook the net partition into one of the two mountings in the roof → Fig. 184 Ⓐ. Ensure that the transverse rod is pulled down over the top position.
- Fit the net partition into the opposite mounting in the roof by pushing the transverse rod together → Fig. 184 Ⓐ.
- Attach both retaining hooks of the net partition to the fastening rings in the luggage compartment and pull the securing straps taut → Fig. 184 Ⓑ.

#### Removing the net partition

- Remove the luggage compartment cover, if necessary → page 267.
- Loosen the net partition straps.
- Unhook the retaining hooks of the net partition from the fastening rings → Fig. 184 Ⓑ.
- Unhook the net partition from one mounting in the roof by pushing the transverse rod together.
- Unhook the net partition from the other mounting in the roof.
- Fold in the net partition → page 268.
- If necessary, fit the luggage compartment cover → page 267.

#### **WARNING**

In the event of a sudden braking manoeuvre or accident, objects could be flung through the interior of the vehicle and lead to severe or fatal injuries.

- Check that the transverse rods are securely engaged.
- Secure objects even if the net partition is installed correctly.
- While the vehicle is moving, no passengers may travel behind the fitted net partition.

#### **NOTICE**

If the net partition is not secured at the mounting points provided for this purpose, this may result in damage.

## Luggage compartment equipment

### Fastening rings

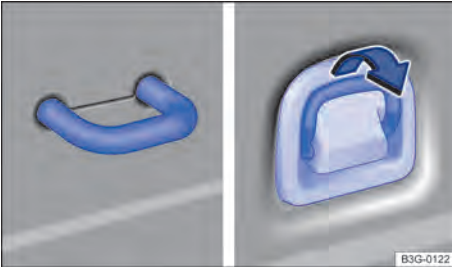

**Fig. 185** In the luggage compartment: fixed and folding fastening rings.

There are fastening rings in the luggage compartment which can be used to secure loose items and luggage with the help of lashing, retaining or securing straps → Fig. 185.

#### **⚠ WARNING**

Unsuitable or damaged lashing, retaining or securing straps could tear in the event of a braking manoeuvre or accident. This could cause objects to be flung through the vehicle interior and lead to severe or fatal injuries.

- Always use suitable and undamaged lashing, retaining or securing straps.
- Pull lashing, retaining and securing straps taut crosswise over the load on the luggage compartment floor and attach the lashing, retaining and securing straps securely to the fastening rings.
- Make sure that the upper edge of the load is higher than the fastening rings, particularly when stowing flat objects.
- Depending on the vehicle equipment, observe the signs about stowing loads that are attached in the luggage compartment.
- Never secure a child seat using the fastening rings.

#### **⚠ WARNING**

Elastic tensioning straps must be stretched to attach to the fastening rings. The hooks attached to them can cause serious injuries.

- Always protect eyes and face from injury when attaching elastic tensioning straps.

- Always hold elastic tensioning straps securely when fastening so that they cannot slip off and snap back.
- Always fasten the elastic tensioning straps first to the fastening rings in the front area of the luggage compartment, then pull them towards the load sill and fasten them to the fastening rings there. If the tension straps slip off, they will snap away from the body.

**i** Suitable lashing, retaining or securing straps and luggage securing systems are available from a correspondingly qualified workshop. Volkswagen recommends using a Volkswagen dealership. <

### Luggage net

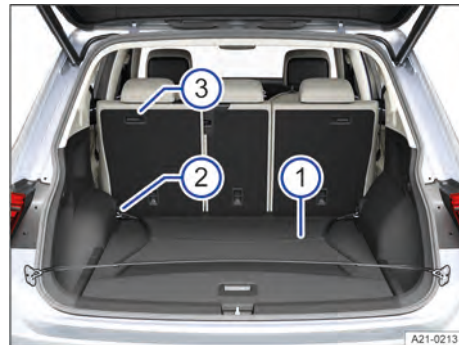

**Fig. 186** In the luggage compartment: luggage net fitted flat.

- ① Luggage net.
- ② Bottom mounting.
- ③ Top mounting.

The luggage net can help to prevent light items of cargo from sliding around in the luggage compartment. The luggage net also has a built-in pocket with a zip that can hold smaller items.

#### **Hooking the luggage net flat on the luggage compartment floor**

1. Attach the luggage net hooks in the front fastening rings → Fig. 186 ② → ⚠. The luggage net zip must face upwards.
2. Attach the hooks on the other end of the luggage net to the fastening rings under the load sill → Fig. 186.

It may be necessary to fold out fastening rings in order to use them → page 270.



### Attaching the luggage net at the seats

1. Attach the hooks of the luggage net on the seats → Fig. 186 ③ → ⚠. The luggage net zip must face upwards.
2. Attach the hooks on the other end of the luggage net to the fastening rings under the load sill → Fig. 186.

It may be necessary to fold out fastening rings in order to use them → page 270.

### Removing the luggage net

When fitted, the luggage net is held taut → ⚠.

1. Unhook the hooks of the luggage net.
2. Stow the luggage net in the luggage compartment.

#### ⚠ WARNING

The elastic luggage net must be stretched when it is secured to the fastening rings in the luggage compartment. When fitted, the luggage net is held taut. The luggage net hooks can cause injuries if the luggage net is installed or removed incorrectly.

- Always hold the luggage net hooks tightly to prevent them from jumping out of the fastening ring during installation or removal.
- Protect your eyes and face to avoid injuries from any hooks that may jump out during installation or removal.
- Always attach the luggage net hooks in the order described. There is a risk of injury if one of the hooks on the luggage net snaps back.

#### ⚠ WARNING

Use the luggage net hooks only for securing a luggage net.

- If they are not used correctly, the luggage net hooks can tear off in the event of a braking manoeuvre or accident. This could cause objects to be flung through the vehicle interior and lead to severe or fatal injuries.
- Never secure a child seat using the luggage net hooks.

### Bag hook

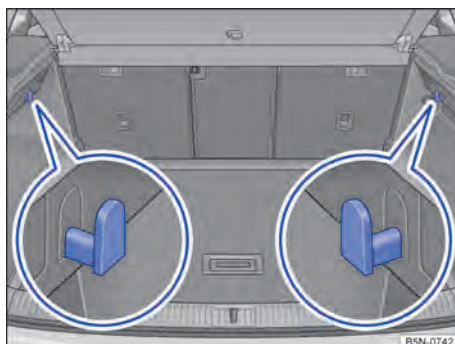

Fig. 187 On the left and right in the luggage compartment: bag hooks.

In the luggage compartment, there may be bag hooks for hanging light shopping bags.

#### ⚠ WARNING

Never use the bag hooks to lash down items of luggage or other objects. The bag hooks could break off during a sudden braking manoeuvre or in the event of an accident.

#### ⓘ NOTICE

Do not load each bag hook with more than 2.5 kg (5 lb).

### Load-through hatch

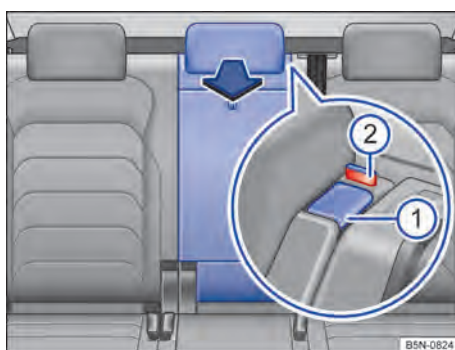

Fig. 188 In the rear seat backrest: opening the load-through hatch.

- ① Release button.

## ② Locking indicator.

Depending on the vehicle equipment, a load-through hatch may be located behind the centre armrest on the rear seat backrest. This can be used to transport long objects in the vehicle interior, such as skis.

### Opening the load-through hatch

1. Press the release button → Fig. 188 ① and fold the load-through hatch forwards → ⚠.
2. Open the boot lid.
3. Push long objects through the load-through hatch from the luggage compartment.
4. Secure the objects with the seat belt.
5. Close the boot lid.

### Closing the load-through hatch

1. Fold back the load-through hatch and push it firmly into the catch until it engages securely into position. The red marking on the locking indicator → Fig. 188 ② must no longer be visible → ⚠.

### ⚠ WARNING

Injuries could be caused if the load-through hatch is folded forwards or backwards carelessly or in an uncontrolled way.

- Never fold the load-through hatch forwards or backwards while the vehicle is in motion.
- Ensure that the seat belt is not trapped or damaged when folding back the load-through hatch.
- Always keep hands, fingers, feet or other body parts away from the swivel area when folding the load-through hatch forwards and backwards.
- The load-through hatch has not been secured properly if the red marking can still be seen on the locking indicator. Always make sure that the red mark is never visible when the load-through hatch is in the upright position.
- Passengers, particularly children, must not use this seat if the load-through hatch is folded forward or is not engaged securely into place.

## Removable luggage compartment light

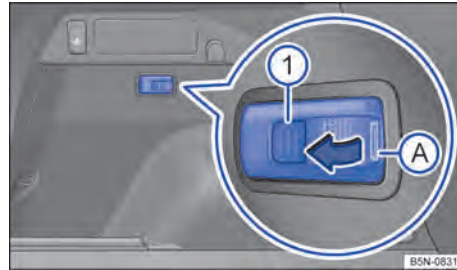

Fig. 189 On the left of the luggage compartment: removable light.

### ① Button.

Depending on the vehicle equipment, there is a removable light in a holder in the luggage compartment → Fig. 189.

When fitted, the removable light is used as a luggage compartment light.

### Removing light from the holder

1. Grip the removable light in the area → Fig. 189 A.
2. Pull the removable light in the direction of the arrow out of the holder.

### Handling the removable luggage compartment light

The removable light is equipped with magnets. After removal, the light can be secured on the vehicle body, for example → ①.

Depending on the equipment, the light brightness can be set to two levels:

1. Press button → Fig. 189 ① to switch on. The light is lit with full luminous power.
2. Depending on version, press the button → Fig. 189 ① again to set the light to 50% power.
3. Press the button → Fig. 189 ① again to switch off the removable light.

### Stowing the removable luggage compartment light in the luggage compartment

1. Switch off the removable light and push it in the opposite direction to the arrow → Fig. 189 into the holder.

## Replacing batteries

The rechargeable batteries of the removable luggage compartment light are charged when it is fitted in the holder and the engine is running.

You should change the batteries if the removable luggage compartment light no longer provides the desired level of brightness.

1. Remove the light from the holder.
2. Lever off the battery cover with a thin object under area → Fig. 189 .
3. Replace the batteries with batteries with the same voltage, size and specifications, making sure they are installed in the right direction.
4. Press the battery cover onto the removable luggage compartment light until the cover audibly clicks into place.

### NOTICE

To avoid damage, stow the removable luggage compartment light securely in the holder in the luggage compartment before driving off.

### NOTICE

Use of conventional batteries or unsuitable rechargeable batteries can damage the removable luggage compartment light and the vehicle electronics.

- Use only rechargeable batteries with the same specification.

## Towing a trailer

### Introduction to the topic

The vehicle can be used to tow a trailer if it has the required technical equipment for this. The additional trailer load will affect the amount of wear, fuel consumption and performance of the vehicle and, in certain circumstances, could shorten the service intervals.

Driving with a trailer not only places an extra load on the vehicle, but also requires increased concentration on the part of the driver.

### Vehicles with start/stop system

When using towing brackets that were not retrofitted by Volkswagen, the start/stop system must be deactivated manually before towing a trailer, and it must remain deactivated for as long as a trailer is being towed → page 144.

## Trailer with function check for lighting

No trailer with tail lights and brake lights must be operated with this vehicle that requires a function check of the tail and brake lights in its approval. Please ask the trailer manufacturer about the approval that is valid for your trailer.

### Unused tow-bar

Swivel in the tow-bar or remove it if there is no trailer, bicycle carrier or similar attached to the tow-bar. This applies in particular if the unused ball coupling covers the number plate or the lighting at the rear of the vehicle. Observe the country-specific regulations on use of a towing bracket → .

### DANGER

It is dangerous to transport people in a trailer and it may also be illegal.

- Never transport people in a trailer.

### WARNING

Improper use of the towing bracket can lead to a loss of vehicle control, accidents and serious injuries.

- Attach and use the trailer in accordance with the instructions supplied by the respective manufacturer.
- Use the towing bracket only if it is undamaged and fitted correctly.
- Do not carry out any alterations or repairs to the towing bracket.
- Swivel in the ball coupling or remove the ball coupling if possible in order to reduce the risk of injury in rear-end collisions and also for pedestrians and cyclists in the case of parked vehicles.
- Never install a "weight-distributing" or "load-balancing" towing bracket on the vehicle. The vehicle was not constructed for these kinds of towing brackets. The towing bracket can fail, causing the trailer to tear loose from the vehicle.

### WARNING

Towing a trailer and transporting heavy or bulky items can change the vehicle handling, increase the braking distance and lead to accidents.

- Always secure loads properly using suitable and undamaged lashing, retaining or securing straps.
- Always adapt your speed and driving style to the current visibility, weather and road or traffic conditions. Reduce speed, particularly when driving downhill.

- Trailers with a high centre of gravity are more likely to tip over than trailers with a low centre of gravity.
- Always pay attention to the road ahead and drive carefully. Accelerate particularly carefully and gently. Avoid abrupt and sudden driving and braking manoeuvres.
- Take special care when overtaking. Reduce your speed immediately if the trailer shows even the slightest sign of snaking.
- Do not drive faster than 80 km/h (50 mph) when towing a trailer, or also 100 km/h (60 mph) in exceptional cases. This also applies to countries where higher speeds are permitted. Keep to country-specific speed limits, which may be lower for vehicles with trailers than for vehicles without trailers.
- Never try to stop a vehicle and trailer from snaking by increasing your speed.

### WARNING

The start/stop system must always be switched off manually when towing a trailer using towing brackets that have not been retrofitted by Volkswagen. Otherwise faults can occur in the brake system, possibly resulting in accidents and serious injuries.

### NOTICE

Please observe the notes and information for vehicles with N1 approval → page 372, *Information about vehicles with N1 approval (light commercial vehicle)*.

 If the connection to a trailer connected to the anti-theft alarm system is interrupted, the anti-theft alarm system may be triggered → page 78.

 In vehicles with a new engine, do not tow a trailer during the first 1,000 km (600 miles) → page 137.

 Some retrofitted towing brackets may cover the opening for fitting the towing eye. If so, the towing eye cannot be used for towing or tow-starting other vehicles. For this reason, the removed ball coupling of a retrofitted towing bracket should be stored in the vehicle at all times.

## Hitching a trailer

 Please refer to   and  at the start of the chapter on page 273.

### Trailer socket

The electrical connection between the towing vehicle and the trailer requires a 13-pin trailer socket. The pin assignment corresponds to DIN ISO 11446.

If the trailer has a **7-pin plug** you will need to use a suitable adapter.

1. Lift up the closure cap of the socket and insert the plug.
2. Turn the plug by quarter of a turn in clockwise direction until it completely engages in the socket.
3. Release the closure cap to lock the plug in position.
4. Check that the entire lighting system is working before starting your journey.

If you are uncertain whether the electrical connection of the trailer with the vehicle is correct, please contact a correspondingly qualified workshop. Volkswagen recommends using a Volkswagen dealership.

### Connection to the anti-theft alarm

The trailer is integrated in the anti-theft system if the following conditions are fulfilled:

- When the vehicle has a factory-fitted anti-theft alarm and a factory-fitted towing bracket.
- When the trailer is electrically connected to the towing vehicle via the trailer socket.
- When the vehicle and trailer electric systems are functional, fault-free and undamaged.
- When the vehicle is locked with the vehicle key and the anti-theft alarm is active.

When the vehicle is locked, the alarm will be triggered as soon as the electrical connection to the trailer is interrupted.

### Connection to the anti-theft alarm (trailer with LED tail light clusters)

 For technical reasons, trailers with LED tail light clusters cannot be integrated into the anti-theft alarm system.

When the vehicle is locked, the alarm is not triggered as soon as the electrical connection to the trailer with LED tail light clusters is interrupted.

## WARNING

Any electrical cables which are not connected properly or are connected incorrectly could cause a power surge to the trailer. This could lead to faults in the entire vehicle electronics system and could also cause accidents and serious injuries.

- Have all work on the electrical system carried out only by a correspondingly qualified workshop. Volkswagen recommends using a Volkswagen dealership.
- Never connect the trailer's electrical system directly to the electrical connections of the towing vehicle's tail light clusters or to other power sources.

## WARNING

Contact between the pins in the trailer socket can lead to short circuits, overloading of the electrical system and failure of the lighting system, thereby causing accidents and serious injuries.

- Never connect the pins in the trailer socket to one another.
- Have bent pins repaired by a correspondingly qualified workshop. Volkswagen recommends using a Volkswagen dealership.

## NOTICE

If you park the trailer using the support wheel or other trailer supports, disconnect the trailer from the vehicle. The vehicle could move up and down if the load changes or if there is damage to the tyres, for example. If this happens, a great deal of force will be exerted on the towing bracket and trailer, which could lead to damage to the vehicle and trailer.

 If there is a fault in the vehicle or trailer electrical systems or if there is a fault in the anti-theft alarm, have the vehicle checked by a correspondingly qualified workshop. Volkswagen recommends using a Volkswagen dealership.

 If the engine is not running and electrical equipment is switched on in the trailer via the trailer socket, the 12-volt vehicle battery will discharge.

 If the 12-volt vehicle battery charge level is low, the electrical connection to the trailer will be interrupted automatically.

## Loading a trailer

 Please refer to ,  and  at the start of the chapter on page 273.

### Basic information

Always make sure that the vehicle and trailer are well-balanced. Do not load the trailer with more weight either at the front or rear. Always stow heavy items as close as possible to or over the axle. Always secure the load on the trailer properly → .

### Maximum trailer weight and drawbar load

The maximum trailer weight is the weight that the vehicle can pull.

The drawbar load is the weight that is exerted vertically from above on the ball coupling of the towing bracket.

Volkswagen recommends always making full use of the maximum permitted drawbar load → page 388. The handling of the vehicle and trailer will be impaired if the drawbar load is too small. However, the maximum permitted load exerted by the trailer drawbar on the ball coupling of the towing bracket must not be exceeded → .

The actually present drawbar load increases the weight on the rear axle and reduces the maximum load of the vehicle as a result.

A higher drawbar load can be used in some countries subject to certain conditions. Observe the country-specific information and regulations.

### Gross combination weight

The gross combination weight is made up of the actual weight of the loaded vehicle and loaded trailer.

In some countries, trailers are divided into different classes. Volkswagen recommends that you contact a correspondingly qualified workshop to find out about suitable trailers. Volkswagen recommends using a Volkswagen dealership.

### Tyre pressure

Follow the trailer manufacturer's recommendations concerning the tyre pressure for the trailer tyres.

When towing a trailer, inflate the tyres on the towing vehicle with the maximum permitted tyre pressure → page 334.

## WARNING

Loads that may slide can severely impair stability and driving safety, which can cause accidents and severe injuries.

- Always load the trailer correctly.

- Always secure loads using suitable and undamaged lashing, retaining or securing straps.

## WARNING

Accidents and serious injuries can occur if you exceed the vehicle's maximum permitted gross axle weight rating, drawbar load, gross vehicle weight rating or gross combination weight rating.

- Never exceed the specified values → page 388.
- Never let the actual weights at the front and rear axles exceed the gross axle weight ratings. Never exceed the permissible gross vehicle weight for the vehicle with weight at the front and rear of the vehicle.

## Driving with a trailer

 Please refer to ,  and  at the start of the chapter on page 273.

### Headlight adjustment

Towing a trailer can raise the front end of the vehicle so that the dipped beam dazzles other road users. Use the headlight range control to lower the light cone as required. Vehicles with dynamic headlight range control are adjusted automatically.



### Things to note when driving with a trailer

- If the trailer has an overrun brake, apply the brakes gently at first and then firmly. This will prevent the jerking that can be caused by the trailer wheels locking.
- The combination weight causes the braking distance to increase.
- On downhill stretches, use the engine as an additional brake. The brake system could otherwise overheat and fail.
  - *Vehicles with a manual gearbox:* Select a lower gear before downhill gradients.
  - *Vehicles with an automatic gearbox:* Select a lower gear in Tiptronic mode.
- The vehicle's centre of gravity and in turn the vehicle handling will change because of the trailer load and the increased gross weight of the vehicle and trailer.
- The weight distribution of a loaded trailer with an unladen towing vehicle is very unfavourable. When driving in this situation, drive particularly carefully and slowly.

### Pulling off on uphill gradients when towing a trailer

A vehicle towing a trailer is liable to roll back a short distance when moving off on an uphill slope depending on the gradient and the gross weight of the trailer and vehicle.

When towing a trailer, pull off on uphill gradient as follows:

1. Depress and hold the brake pedal.
2. Press the  button once to switch off the electronic parking brake → page 191.
3. *Vehicles with a manual gearbox:* fully depress the clutch pedal and engage 1st gear.
  - ◀ *Vehicles with an automatic gearbox:* engage the gear selector position for forward driving.
4. Pull the  button and hold it in this position to hold the vehicle and trailer with the electronic parking brake.
5. Release the brake pedal.
6. Pull away slowly.
7. Release the  button only when the engine has sufficient power to move off.

## WARNING

Incorrect trailer towing can cause loss of vehicle control and serious injuries.

- Towing a trailer and transporting heavy or bulky items can change the way the vehicle handles and increase the braking distance.
- Make sure that you have an adequate view to the rear. Fit additional exterior mirrors if the view to the rear is not guaranteed due to the trailer. Volkswagen recommends using Volkswagen Genuine Parts or Volkswagen Genuine Accessories, which you can purchase from a Volkswagen dealership.
- Always pay attention to the road ahead and drive carefully. Brake earlier than usual.
- Always adapt your speed and driving style to the current visibility, weather and road or traffic conditions. Reduce speed, particularly when driving downhill.
- Accelerate particularly carefully and gently. Avoid abrupt and sudden driving and braking manoeuvres.
- Take particular care when overtaking. Reduce your speed immediately if the trailer shows even the slightest sign of snaking.
- Never try to stop a vehicle and trailer from snaking by increasing your speed.

- Keep to speed limits, which may be lower for vehicles with trailers than for vehicles without trailers.

## Trailer stabilisation

📖 Please refer to ⚠️, ⚠️ and ⌚ at the start of the chapter on page 273.

The trailer stabilisation function can detect if an attached trailer is starting to snake from side to side and can provide countersteer.

Trailer stabilisation is an extension of the Electronic Stability Control (ESC).

If trailer snaking is detected, the trailer stabilisation function automatically helps to reduce the trailer's motion using counter steering assistance.

### Prerequisites for trailer stabilisation

- The vehicle has a factory-fitted towing bracket or a compatible towing bracket has been retrofitted.
- Electronic Stability Control and traction control system (TCS) are active. The indicator lamp 🚦 or 🚦 in the instrument cluster is not lit up.
- The trailer is electrically connected to the towing vehicle via the trailer socket.
- The vehicle speed is higher than approximately 60 km/h (37 mph).
- The maximum drawbar load is being used.
- The trailer must have a rigid drawbar.
- Trailers with brakes must have a mechanical over-run system.

### ⚠️ WARNING

Do not let the extra safety afforded by the trailer stabilisation function tempt you into taking any risks when driving.

- Always adapt your speed and driving style to the current visibility, weather and road or traffic conditions.
- Accelerate carefully on slippery surfaces.
- Ease off the accelerator if a system is performing a control intervention.

### ⚠️ WARNING

The trailer stabilisation function may not be able to detect all driving situations correctly.

- Trailer stabilisation is switched off when ESC is deactivated.

- Light trailers that are snaking will not be recognised by the trailer stabilisation function and stabilised accordingly in all cases.
- A trailer can still *jack-knife* on slippery roads with little grip, even if the towing vehicle is equipped with the trailer stabilisation system.
- Trailers with a high centre of gravity might tip over before snaking starts.
- Sudden braking procedures could occur automatically in extreme driving situations if the trailer socket is being used without a trailer (e.g. for a bicycle carrier with lighting).

## Towing bracket

### Swivelling out the ball coupling

The ball coupling of the towing bracket is located in the bumper. The electrically released ball coupling is swivelled out mechanically for use and cannot be removed.



**Fig. 190** On the right of the luggage compartment: button for releasing the ball coupling.

- ① Button for releasing the tow-bar.

### Releasing and swivelling out the ball coupling

1. Park the vehicle → page 191.
2. Open the boot lid.
3. Briefly pull the 🚦 → Fig. 190 button in the luggage compartment.

The ball coupling is released electrically and swivels out automatically. The indicator lamp in the button flashes.

4. Continue swivelling the ball coupling until you hear and feel it click into place and the indicator lamp in the button lights up continuously.
5. Close the boot lid.

#### Swivelling in the ball coupling

1. Park the vehicle → page 191.
2. Unhitch the trailer and disconnect the electrical connection between the vehicle and the trailer. If fitted, remove the adapters from the trailer socket.
3. Open the boot lid.
4. Briefly pull the  → Fig. 190 button in the luggage compartment.  
The ball coupling is released electrically.
5. Swivel the ball coupling under the bumper until you hear and feel it click into place and the indicator lamp in the button lights up continuously.
6. Close the boot lid.

#### Meaning of indicator lamp in the button

- Indicator lamp in the button → Fig. 190 *lights up continuously* when the boot lid is open: the tow-bar has engaged correctly in swivelled out or swivelled in position.
- The indicator lamp in the button *flashes*: the ball coupling has not engaged properly or the ball coupling is damaged → .
- The indicator lamp in the button goes out approximately 1 minute after the boot lid is closed.

#### Safety cable

In some countries, unbraked and braked trailers must be secured by means of a safety or breakaway cable.

Observe the country-specific regulations on using a safety cable.

1. Secure the safety or breakaway cable at the eye provided for this purpose on the ball coupling.
2. Guide the cable through the eye and hook in the snap hook → .

#### WARNING

Improper use of the towing bracket can cause injury and accidents.

- Use the ball coupling only if it is correctly engaged in position.
- Make sure that no people, animals or items are in the path of the ball coupling.
- Never interrupt the swivel movement of the ball coupling with items or tools.

- Never press the  button if a trailer is attached or if a luggage carrier or other add-on parts are fitted to the ball coupling.
- Do not use the towing bracket if the ball coupling is not engaged in position correctly or if there are faults in the electrical system or on the towing bracket itself. Have the ball coupling checked by a correspondingly qualified workshop. Volkswagen recommends using a Volkswagen dealership.
- Never use the towing bracket if the diameter of the ball at the smallest point is less than 49 mm (1.9 in).



#### WARNING

Injuries and accidents can be caused if the trailer is not secured correctly.

- Never place the trailer's safety or breakaway cable loosely over the ball coupling.

#### NOTICE

Do not aim a high-pressure cleaner or steam cleaner directly at the swivelling ball coupling or the fitted trailer socket. Seals could be damaged or the grease required for lubrication could be washed off.

 At extremely low outside temperatures, it may not be possible to swivel the ball coupling in or out. If this happens, it is sufficient to place the vehicle in a warmer room, e.g. a garage. 



## Dimensions and mounting points for retrofitting a towing bracket

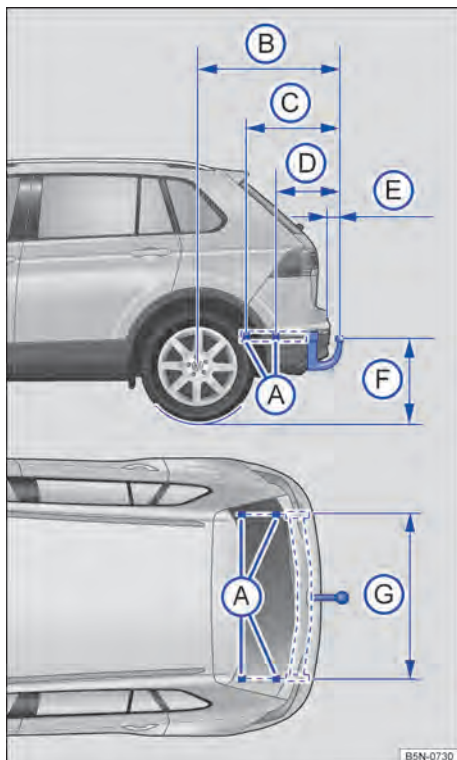

**Fig. 191** Dimensions and mounting points for retrofitting a towing bracket.

The distance dimensions → Fig. 191 must be observed in all cases when retrofitting a towing bracket. Always observe the minimum distance given from the middle of the ball coupling (F) to the surface of the road. This also applies when the vehicle is fully laden, including maximum drawbar load.

- (A) Attachment points.
- (B) 989 mm (approx. 38.9 in)
- (C) 595 mm (approx. 23.4 in)
- (D) 348 mm (approx. 13.7 in)
- (E) at least 65 mm (approx. 2.6 in)
- (F) 350 to 420 mm (approx. 13.8 in to 16.5 in)
- (G) 1,061 to 1,066 mm (approx. 41.8 to 42 in)

Volkswagen recommends having the towing bracket retrofitted by a correspondingly qualified workshop. The cooling system may need to be modified or heat

shields may need to be fitted, for example. Volkswagen recommends using a Volkswagen dealership.

Mount the towing bracket in accordance with the supplied installation instructions.

A retrofitted, non-removable towing bracket must not cover either the number plate or the lighting system at the rear of the vehicle. Observe the country-specific regulations on use of a towing bracket → ⚠.

### ⚠ WARNING

Electrical cables that are not connected properly or are connected incorrectly can cause faults in the entire vehicle electronics system and also cause accidents and serious injuries.

- Never connect the trailer's electrical system directly to the electrical connections of the tail light clusters or to other unsuitable power sources. Use only suitable connectors to connect the trailer.
- Have retrofitting of a towing bracket on the vehicle performed by a correspondingly qualified workshop. Volkswagen recommends using a Volkswagen dealership.

### ⚠ WARNING

The trailer can become detached from the towing vehicle if the towing bracket is unsuitable or incorrectly fitted. This can cause serious accidents and fatal injuries.

 Use only towing brackets that are intended by the manufacturer for the corresponding vehicle model, model year and vehicle version. Volkswagen recommends using Volkswagen Genuine Parts or Volkswagen Genuine Accessories, which you can purchase from a Volkswagen dealership. <

## Troubleshooting

### Ball coupling of the towing bracket is not locked

The indicator lamp lights up yellow.

1. Do not use towing bracket. Check the towing bracket locking mechanism → page 277.
2. If the problem persists, go to a correspondingly qualified workshop. Volkswagen recommends using a Volkswagen dealership. <

## Bicycle carrier

### Fitting a rear carrier system or bicycle carrier on the tow-bar

Rear carrier systems include equipment such as bicycle carriers or hunters' boxes, for example, which are installed on the tow-bar.

Use only rear carrier systems that are intended by the manufacturer for the corresponding vehicle model, model year and vehicle version → .

Volkswagen recommends using Volkswagen Genuine Parts or Volkswagen Genuine Accessories, which you can purchase from a Volkswagen dealership.

Mount the rear carrier system in accordance with the manufacturer's assembly instructions.

#### Maximum load of the rear carrier system



**Fig. 192** Recommended weight distribution on the rear carrier system.

The load is made up of the rear carrier system and the items transported on it.

The maximum recommended load of the rear carrier system installed on the tow-bar can deviate from the vehicle-specific drawbar load of the vehicle.

However, the model-specific maximum drawbar load of the towing bracket must not be exceeded.

Due to the lever effect, the load capacity decreases the further the centre of gravity of the rear carrier system is away from the ball head.

Position heavy items as close as possible to the tow-bar → **Fig. 192**.

#### Vehicle-specific maximum load

In order to find out the recommended maximum load for your vehicle, check the drawbar load of your vehicle → page 388. The corresponding maximum load can then be read from the following table.

Volkswagen recommends observing the specified number of bicycles on the rear carrier system in accordance with Regulation UN-R 55.

Vehicle-specific drawbar load	Maximum load	Number of bicycles
50 kg	50 kg	2
55 kg	55 kg	2
from 75 kg	75 kg	3

#### Maximum overhang of the rear carrier system



**Fig. 193** Illustration of the maximum overhang on a bicycle carrier for two or three bicycles.

- (A) With a load of up to 55 kg: 500 mm (approx. 19.7 in).
- (B) For a load of 75 kg: 700 mm (approx. 27.6 in).

For bicycle carrier systems with two bicycles, the maximum overhang must not exceed 500 mm → **Fig. 193** (A) from the middle of the ball head to the middle of the rail of the last bicycle carrier. The overhang must not exceed 700 mm → **Fig. 193** (B) for bicycle carrier systems with three bicycles.

#### WARNING

Incorrect use of a rear carrier system mounted on the tow-bar of the towing bracket can cause accidents and injuries.

- Make sure that the rear carrier system is suitable for use on your vehicle.
- Always read and observe the fitting instructions of the rear carrier system's manufacturer.
- Never secure a rear carrier system on the ball neck below the ball head. The rear carrier system could slip due to the shape of the ball neck.

 Volkswagen recommends that you remove all add-on parts of the load on the rear carrier system before setting off. This includes bicycle bags

and baskets, child seats or batteries. This helps improve the rear carrier system's wind load and centre of gravity.

## Roof carrier

### Introduction to the topic

Some vehicle models are designed for fitting a roof carrier.

Roof carriers can be used to transport bulky items on the roof of the vehicle.

If you are unsure whether a roof carrier can be fitted on your vehicle, please contact a correspondingly qualified workshop. Volkswagen recommends using a Volkswagen dealership.

Only use roof carriers that have been approved by Volkswagen for your vehicle type.

If the vehicle is *not* approved for use with a roof carrier, do *not* use or retrofit a roof carrier.

### WARNING

When transporting heavy or bulky objects in the roof carrier, the vehicle's handling will change due to a shift in the centre of gravity and an increased susceptibility to crosswinds.

- Always secure loads properly using suitable and undamaged lashing, retaining or securing straps.
- Cargo that is large, heavy, bulky, long or flat will have a negative effect on the vehicle aerodynamics, centre of gravity and overall handling.
- Avoid abrupt and sudden driving and braking manoeuvres.
- Ensure that your speed and driving style are always appropriate for the current visibility, weather and road/traffic conditions.

### WARNING

A roof carrier that has *not* been approved for the vehicle or a roof carrier that is fitted to a vehicle that is *not* approved for use with a roof carrier may cause accidents or injuries.



- Use only roof carriers that have been approved by Volkswagen for your vehicle.
- Never fit a roof carrier on a vehicle that has not been approved for use with a roof carrier.
- A roof carrier that is fitted nevertheless may become loose whilst the vehicle is in motion and fall from the vehicle roof.

### NOTICE

Securing a roof carrier of any kind to a vehicle that is *not* approved for use with a roof carrier may lead to severe damage to the vehicle.

Driving with a fitted roof carrier increases the air resistance of the vehicle and thus also the fuel consumption. The possible range of the vehicle is reduced as a result. This applies to all roof carriers and the objects transported on them, e.g. bicycles and skis.

### Fitting a roof carrier

Please refer to  and  at the start of the chapter on page 281.

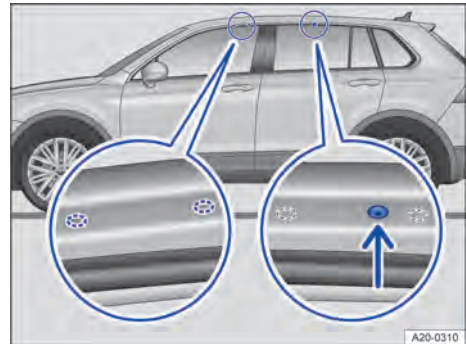

Fig. 194 Mounting points for base carriers (vehicles without roof rails).

Special roof carriers must be used to transport luggage, bicycles, skis, surfboards or boats safely.

Use only roof carriers that are intended by the manufacturer for the corresponding vehicle model, model year and vehicle version.

Volkswagen recommends using Volkswagen Genuine Parts or Volkswagen Genuine Accessories, which you can purchase from a Volkswagen dealership.

#### Fitting a roof carrier (vehicles without roof railings)

Fit the roof carrier in accordance with the supplied installation instructions → .

The bores or markings for securing the roof carrier are visible only when the doors are open. If necessary, unscrew the plastic screw from the bore opening.

The front bores or markings are located on the undersides of the roof side members in the area of the door seal.

The rear bores or markings are located on the undersides of the roof side members in the area of the door seal or, depending on the vehicle equipment, at the top of the rear side windows.

Once you have fitted the roof carrier, you can then secure the respective load carrier on this → .

#### Fitting the roof carrier on the roof railings

Fit the roof carrier in accordance with the supplied installation instructions → .

Once you have fitted the roof carrier, you can then secure the respective load carrier on this → .

#### Remove the roof carrier in the following situations

- The roof carrier is no longer needed.
- Before entering a car wash.
- When the vehicle height exceeds the required clearance height, e.g. in a garage.



#### NOTICE

- The height of the vehicle is changed by the installation of a roof carrier and the load secured to it. Check and compare the height of the vehicle with clearance heights, e.g. for underpasses and garage doors.
- The roof carrier and load must not interfere with equipment-dependent components on the vehicle roof such as a roof aerial or glass roof or impede the swivel range of the boot lid.



#### WARNING

Incorrectly attaching and using the roof carrier and load carrier could cause the luggage or entire structure to fall off the roof. This could cause accidents and injuries.

- Use the roof carrier and load carrier only if they are undamaged and fitted correctly.
- Always fit the roof carrier and load carrier correctly. Always observe the installation instructions provided by the manufacturer.
- Attach the roof carrier only at the specified mounting points.
- Special load carriers for items such as bicycles, skis, surfboards, etc. should always be properly installed. Always observe the installation instructions provided by the manufacturer.
- Check that the roof carrier is secured before starting your journey and tighten as necessary after driving a short distance. During a long trip, check all bolts and fasteners at each stop.
- Do not carry out any modifications or repairs to the roof carrier or the load carrier.

 Fitting a roof carrier increases air resistance and may reduce the vehicle's range. 

### Loading a roof carrier

 Please refer to  and  at the start of the chapter on page 281.

#### Maximum permissible roof load

The maximum permitted roof load is **75 kg (165 lbs)**

The roof load limit refers to the combined weight of the roof carrier and the load carried on the roof → .

Make sure you are aware of the weight of the roof carrier and the load to be transported. Weigh the load if necessary.

However, you will not be able to carry the maximum roof load if you are using a roof carrier with a lower weight rating. In this case, do not exceed the maximum weight limit for the roof carrier which is specified in the manufacturer's installation instructions.

#### Distributing the load

Distribute the load evenly and secure it correctly → .

#### Checking mounting

After fitting the roof carrier, drive a short distance and then check all mounting elements. Check again at regular intervals.

#### WARNING

Accidents and vehicle damage can occur if the maximum permitted roof load is exceeded.

- Never exceed the specified roof load, the maximum permissible axle loads, and the permissible gross vehicle weight for the vehicle.
- Do not exceed the load capacity of the roof carrier, even if the maximum roof load has not been reached.

#### WARNING

Loose and incorrectly secured loads can fall off the roof carrier and cause accidents and injuries.

- Always use suitable and undamaged lashing, retaining or securing straps.

#### NOTICE

When opening the boot lid, make sure that it does not collide with the roof load. 

# Fuel and emission control

## Safety information on using fuel

### **⚠ WARNING**

Incorrect handling of fuel can cause explosions, fire, serious burns and other injuries.

- Switch off the engine, ignition, your mobile phone and other radio equipment before refuelling.
- Before refuelling, switch off the auxiliary heater → page 126.
- Do not get into the vehicle while refuelling in order to avoid electrostatic discharge.
- Make sure that the tank cap is closed properly and no fuel can escape.
- Observe the applicable safety instructions and local regulations on handling fuel.

### **⚠ WARNING**

Incorrect refuelling can lead to fire, serious injuries and vehicle damage.

- Use only fuels that have been approved for the vehicle.
- Do not use fuels that contain metals and use only Volkswagen-approved service additives in the approved quantity.
- Immediately remove any fuel that is spilled from all vehicle components.

### **⚠ CAUTION**

Fuel may run out of the fuel canister. This could cause fire and injuries.

- Do not carry a fuel canister in the vehicle.

 Fuels can pollute the environment. Collect any service fluids that escape or are spilled and dispose of them correctly.

 The tank flap cannot be opened manually. Seek expert assistance in an emergency.

## Fuel types and refuelling

### Introduction to the topic

The tank flap is located at the rear right-hand side of the vehicle.

## Identification of fuels and fuel standards

 Please refer to  and  on page 283.



**Fig. 195** On the inside of the tank flap: fuel information label (illustration).

### Fuel information label

Different engines require different fuels. There is a factory-fitted fuel information sticker in the tank flap that indicates the required fuel type for the vehicle → Fig. 195.

The designation and frame indicate the fuels that are suitable for the vehicle. This is the minimum requirement. The vehicle must not be refuelled with other fuels → .

### Fuel standards

The fuel that is used for refuelling must comply with one of the following standards. The vehicle must not be refuelled with other fuels → .

Where fuel complying with the specified standards is not available, a correspondingly qualified workshop will have information on which available fuels are suitable for the vehicle. Volkswagen recommends using a Volkswagen dealership.

### Petrol



**Fig. 196** Petrol fuels containing ethanol.

E5 stands for petrol fuel with a maximum ethanol content of 5%.

### Fuel standard

- EN 228 in the current version.
- DIN EN 228 in the current version.

- Resolucao ANP N° 40 (Brazil) in the current version.
- Resolucion 576/2019 (Argentina) in the current version.
- NOM-016-CRE-2016 (Mexico) in the current version.

#### Diesel



**Fig. 197** Diesel fuels containing biodiesel.

B7 stands for diesel fuel with a maximum biodiesel content of 7%.

#### Fuel standard

- EN 590 in the current version.
- DIN EN 590 in the current version.



**Fig. 198** Synthetic diesel fuels.

XTL stands for **X** - **T**o - **L**iquid and designates synthetic diesel fuels.

#### Fuel standard

- EN 15940 in the current version.
- DIN EN 15940 in the current version.

#### NOTICE

Using fuel that does not comply with the applicable standards and are not approved may reduce performance and cause damage to the engine and fuel system.

- Before refuelling, check whether the fuel designations on the pump meet the vehicle requirements.
- In order to avoid damage to the fuel system and engine failure, refuel only with fuels that comply with the specified standard and identification. ◀

## Petrol

 Please refer to  and  on page 283.

#### Petrol grades

Petrol grades differ with respect to their Research Octane Number (RON). The vehicle may also be filled with petrol that has a higher RON than the engine requires. However, this does not provide any advantage in terms of fuel consumption or engine output.

The fuel information label may show several petrol grades (e.g. RON 95 min. 91). The highlighted octane number, RON 95 in the example, is the preferred petrol grade for which the vehicle has been designed and optimised. The petrol grade listed as an alternative, ROZ 91 in the example above, can be used for refuelling only if the preferred grade, ROZ 95 in the example, is not available.

Always refuel vehicles with a petrol engine only with metal-free petrol (without lead, manganese or iron) that has a maximum ethanol content of 10% (E10) → .

The fuel quality affects the running properties, performance and service life of the engine. Refuel with fuel that already contains suitable fuel additives → .

Volkswagen recommends "TOP TIER Detergent Gasoline". This fuel is available in a number of regions, e.g. North America, Central America and South America. Further information on "TOP TIER Detergent Gasoline" is available on the official website: <http://www.toptiergas.com>

#### NOTICE

Incorrect refuelling or unsuitable fuel additives can cause damage to the vehicle.

- Before refuelling, check whether the fuel standard specified on the pump meets the vehicle's requirements.
- Use only Volkswagen-approved service additives in the approved quantity if necessary.
- Refuel only with petrol that has the specified Research Octane Number (RON) or a higher one. If, in an emergency, you have to use petrol with an octane number lower than the recommended number, drive at medium engine speeds and avoid high engine loading. Avoid high engine speeds and heavy engine loads. Refuel with petrol with the correct octane number as soon as possible. ◀

## Diesel

📖 Please refer to ⚠️ and ⚠️ on page 283.

Fill vehicles with a diesel engine only with diesel or diesel with a maximum RME fuel content of 7 % → ⚠️

If you use diesel with a high sulphur content, the service intervals are shorter. Suitably qualified workshops can provide information on countries that use diesel with a high sulphur content. Volkswagen recommends using a Volkswagen dealership.

The fuel quality affects the running properties, performance and service life of the engine. Refuel with fuel that already contains suitable service additives → ⚠️

### Winter-grade diesel fuel and filter preheater system

Diesel fuel with improved cold flow properties (winter-grade diesel fuel) must be used during the winter months. Refuelling with winter-grade diesel fuel can prevent malfunctions in vehicle operation. Winter-grade diesel fuel is available at filling stations during the winter months.

Different climate- and time-dependent cold classes may be defined in country-specific fuel standards → page 283.

Diesel vehicles are equipped with a filter preheater system. The filter preheater system guarantees the cold flow properties of the diesel fuel when driving. Information on the cold properties of diesel is available from filling stations in the respective country.

In order to ensure that the vehicle can also be started at low outside temperatures, Volkswagen recommends parking the vehicle in a location that is protected from the weather, e.g. in a garage.

### Misfuelling prevention device

The tank filler neck in diesel vehicles may be fitted with a misfuelling prevention device. This is intended to help ensure that the vehicle is refuelled only using diesel filler nozzles.

If the nozzle cannot be inserted correctly into the tank filler neck, first check whether you are using a diesel filler nozzle. When you have made sure that you are using the correct filler nozzle, move the diesel filler nozzle to and fro slightly with light pressure. This can open the misfuelling prevention device and make it possible to refuel the vehicle. If the misfuelling prevention device still remains closed, go to a suitably qualified workshop and have the system checked. Volkswagen recommends using a Volkswagen dealership.

If it is necessary to refuel the vehicle using a spare fuel canister in the event of an emergency, the misfuelling prevention device will not open.

In order to fill the fuel tank despite this, pour the diesel into the tank extremely slowly in very small quantities. Use a suitable adapter for the spare fuel canister in order to make refuelling easier. The relevant adapters are available from a suitably qualified workshop. Volkswagen recommends using a Volkswagen dealership.

### ⚠️ WARNING

Incorrect refuelling can lead to fire, serious injuries and vehicle damage.

- Before refuelling, check whether the fuel standard specified on the pump meets the vehicle's requirements.
- Do not refuel with pure RME fuel, petrol, fuel oil or other unsuitable fuels.
- Use only Volkswagen-approved service additives in the approved quantity.

🔧 At cold temperatures, louder noises may occur in the diesel engine and the exhaust gas may be tinged blue. <



## Refuelling

📖 Please refer to ⚠️ and ⚠️ on page 283.



Fig. 199 Behind the tank flap: tank cap (illustration).

### Refuelling process

1. To unlock the tank flap, unlock the vehicle with the  button in the vehicle key → page 71.  
**Or:** to unlock the tank flap, unlock the vehicle with the  button in the driver door → page 75.  
In vehicles with Keyless Access, the tank flap is unlocked automatically when the vehicle is unlocked.
2. Open the tank flap.

3. Unscrew the tank cap and place it in the opening provided in the tank flap → Fig. 199.
4. Hold the nozzle so that the handle is facing downwards in order to guarantee optimum refuelling.  
The fuel tank is full when the filler nozzle clicks off for the first time → ⚠.
5. Screw the tank cap onto the tank filler neck.
6. Close the tank flap.

Do not continue filling the tank after it switches off. The expansion space in the fuel tank can fill with fuel, for example if it heats up. This could cause fuel to overflow or automatic venting may not function → page 290.

### ⚠ WARNING

Overfilling the fuel tank may cause the fuel to splash out and overflow. This can cause fires, explosions and serious injuries.

- Do not continue refuelling when the filler nozzle switches off for the first time.

### ℹ NOTICE

If possible, every six months, drive the fuel tank empty until the indicator lamp lights up and then refuel. This is necessary to maintain the system function and fuel quality required for operation.

 Fuels can pollute the environment. Collect any service fluids that escape or are spilled and dispose of them correctly.

## Emission control

### 📖 Introduction to the topic

The components relevant to emission control reduce harmful emissions:

- AdBlue® → page 286.
- Catalytic converter → page 290.
- Particulate filter (depending on equipment) → page 290.

### ⚠ WARNING

Engine emissions contain carbon monoxide that can cause people to lose consciousness and can also cause death.

- Do not allow the engine to run in enclosed spaces.
- Never start the engine in enclosed spaces.

- Do not leave the vehicle unattended if the engine is running.

### ⚠ WARNING

The components of the exhaust system become very hot. This can cause fires.

- Park the vehicle so that no part of the exhaust system can come into contact with any inflammable material underneath the vehicle, e.g. dry grass.
- Do not apply additional underseal or anti-corrosion coatings to the exhaust pipes, catalytic converters, particulate filter or the heat shields.

### AdBlue®

📖 Please refer to ⚠ and ⚠ on page 283 and ⚠ at the start of the chapter on page 286.

The SCR catalytic converter uses AdBlue® urea solution to convert nitrogen oxides into nitrogen and water. AdBlue® is a registered trademark and is also known as AUS32 or DEF (Diesel Exhaust Fluid).

### Legal information

No technical modifications should be made to the emission control system that could influence emission control by AdBlue®.

Only operation with AdBlue® that complies with ISO-22241-1 is approved by Volkswagen and corresponds to the Certificate of Conformity issued for this vehicle type.

Operating the vehicle without AdBlue® that complies with ISO-22241-1 may be a criminal offence.

The emission values may be negatively affected if the emission control system is not operated as intended.

### Information on AdBlue®

The AdBlue® consumption figures depend on the driving style, the operating temperature and the ambient temperature. The remaining range and refill quantity can be checked on the instrument cluster display → page 20.

As AdBlue® freezes at -11 °C (+12 °F), refuelling may be restricted at very low temperatures. During vehicle operation, the system is heated to ensure emission control even at very low temperatures.



During prolonged spells of cold weather with temperatures below -11°C (+12°F), and in extremely adverse conditions, it is possible that the AdBlue® cannot be defrosted and is not available for the emission control system → page 289.

AdBlue® must be refilled independently of the service events. This may be necessary more frequently and between the service intervals.

The AdBlue® tank must never run empty → page 290.

#### Warning and driver inducement system for low tank level

Always add AdBlue® when a request to add it appears in the instrument cluster display.

When the white indicator light  lights up, AdBlue® is still in the normal operating range. It is possible to refill AdBlue®, but it is not necessary.

From a **remaining range of 2,000 km (1200 miles) or 2,400 km (1500 miles)** (depending on equipment), a prompt to refill AdBlue® appears on the instrument cluster display. The current remaining range is displayed along with this prompt → page 289.

If this warning is ignored, the yellow indicator lamp lights up in the instrument cluster display at a **remaining range of 1000 km (600 miles)** . A message is displayed on the instrument cluster with the warning that it will no longer be possible to restart the engine in XXX km (XXX miles).

If the yellow indicator lamp is still ignored and the displayed **remaining range is 0 km (0 miles)**, it is not possible to restart the engine. The red warning lamp  lights up.

#### Warning and driver inducement system in the event of faults

The white or yellow indicator lamps  light up if the emission control system is faulty or is not filled with standard-compliant AdBlue® according to ISO-22241-1. There is a **remaining range of 1,000 km (600 miles)** from when the yellow indicator lamps light up.

If the yellow indicator lamps are still ignored, the red warning lamps  light up. There is a **remaining range of 0 km (0 miles)** and it is not possible to restart the engine.

#### CAUTION

AdBlue® is an irritant and corrosive fluid that can damage the skin, eyes and breathing passages upon contact.

- Always observe the instructions for use when using AdBlue®. If you follow the instructions

correctly you should not come into contact with AdBlue®.

- AdBlue® must be kept only in the closed original container. Never use empty food tins, bottles or other containers.
- Always store AdBlue® in a safe place out of reach of children.
- If AdBlue® gets into the eyes, immediately rinse the eyes with plenty of water for at least 15 minutes and consult a doctor.
- If AdBlue® gets onto the skin, immediately rinse the skin with plenty of water for at least 15 minutes and consult a doctor.
- If AdBlue® is swallowed, immediately rinse the mouth out with plenty of water for at least 15 minutes. Do not induce vomiting unless instructed to do so by a doctor. Seek medical assistance immediately.

#### NOTICE

If the AdBlue® level is too low, the vehicle cannot be restarted after the ignition has been switched off. Starting with jump leads is also not possible.

- Refill with AdBlue® in accordance with the quantity shown on the instrument cluster display at the latest when the remaining range is around 1,000 km (600 miles).
- Never allow the AdBlue® tank to run empty.

#### NOTICE

Improper use of AdBlue® may cause damage to the vehicle that is not covered by the warranty.

- Use only AdBlue® that complies with the standard ISO 22241-1.
- Never add water, fuel or additives to the AdBlue®.
- Never fill AdBlue® in the diesel fuel tank.
- Do not permanently carry the refill bottle in the vehicle. The bottle may develop a leak following changes in temperature and damage and the AdBlue® may damage the vehicle interior.

## Refilling AdBlue®

📖 Please refer to ⚠️ and ⚠️ on page 283 and ⚠️ at the start of the chapter on page 286.



Fig. 200 Behind the tank flap: tank cap for AdBlue (illustration).



Fig. 201 Behind the tank flap: refilling AdBlue using the refill bottle (illustration).



Fig. 202 Behind the tank flap: refilling AdBlue using the nozzle (illustration).

- ① Cap for the AdBlue® filler neck.
- ② Refill bottle.
- ③ AdBlue® nozzle

### Preparing for refilling

The AdBlue® filler neck is located behind the tank flap next to the tank filler neck for fuel → Fig. 200.

1. Park the vehicle on a level surface and switch off the ignition.
2. Open the tank flap.
3. Remove the cap from the AdBlue® filler neck.

Only use AdBlue® that complies with the standard ISO 22241-1.

### Refilling with the refill bottle

Observe the manufacturer's use-by specifications, instructions and information on the refill bottle.

1. Remove the screw top of the refill bottle.
2. Place the refill bottle on the AdBlue® filler neck and tighten the refill bottle.
3. Do not squeeze the refill bottle to prevent it from being damaged.
4. Press the refill bottle towards the filler neck and hold it in this position.
5. Fill with at least the minimum and not more than the maximum refill quantity of AdBlue® shown in the instrument cluster display.
6. To ensure that the tank is not overfilled, do not squeeze the refill bottle → ①.
7. Unscrew the refill bottle.

### Filling with a filler nozzle

The AdBlue® tank can be refilled at all AdBlue® pumps.

Do not fill fuel and AdBlue® at the same time.

The AdBlue® filler nozzle works in the same way as a filler nozzle for fuel.

1. In order to guarantee optimum refuelling, hold the AdBlue® nozzle so that the handle is facing downwards → Fig. 202.
2. Fill with at least the minimum and not more than the maximum refill quantity of AdBlue® shown in the instrument cluster display.
3. To avoid overfilling the AdBlue® tank, do not continue refuelling after adding the maximum refill quantity of AdBlue®.

The AdBlue® tank is full when the filler nozzle clicks off for the first time → ①.

### Filling with a canister

1. Remove the cap from the canister.
2. Use the integrated spout to refill the AdBlue® tank.

- Fill with at least the minimum and not more than the maximum refill quantity of AdBlue® shown in the instrument cluster display.
- To avoid overfilling the AdBlue® tank, do not continue refuelling after adding the maximum refill quantity of AdBlue®.

Do not overfill the AdBlue® tank → .

### Preparing to continue your journey

- Screw in the cap on the AdBlue® filler neck until it engages → [Fig. 200](#).
- Close the tank flap.
- Switch on only the ignition for at least 30 seconds so that refilling can be detected by the system.
- Then start the engine afterwards.

### NOTICE

Overfilling AdBlue® may damage the tank system and the vehicle.

- Do not fill with more than the maximum refill quantity indicated on the instrument cluster display.
- Remove any spilled AdBlue® as quickly as possible with a damp cloth and plenty of cold water.
- Remove any crystallised AdBlue® with warm water and a sponge.

 Dispose of the refill bottle in an environmentally responsible way.

 Suitable AdBlue® refill bottles are available from a Volkswagen dealership.

## Troubleshooting

 Please refer to  and  on page 283 and  at the start of the chapter on page 286.

### Selective catalytic reduction system fault

The white  indicator lamps light up.

There is a fault in the selective catalytic reduction system or the system is not filled with standard-compliant AdBlue®.

- Drive to a suitably qualified workshop. Volkswagen recommends using a Volkswagen dealership.
- Have the system checked.

If the fault is not rectified in the next 50 km, the  indicator lamps light up yellow and the re-

maining range is approximately 1,000 km (around 600 miles).

### Selective catalytic reduction system fault

The yellow  indicator lamps light up.

The instrument cluster display shows a text message **AdBlue fault! No engine start in XXX km (XXX miles)**.

There is a fault in the selective catalytic reduction system or the system is not filled with standard-compliant AdBlue®.

The remaining range is approximately 1,000 km (600 miles).

- Drive immediately to a suitably qualified workshop. Volkswagen recommends using a Volkswagen dealership.
- Have the system checked.

**Or:** during prolonged spells of cold weather with temperatures below -11°C (+12°F), and in extremely adverse conditions, it is possible that the AdBlue® cannot be defrosted and is not available for the emission control system.

- Drive the vehicle to a warmer environment with an ambient temperature higher than -11°C (+12°F) within the stated range, such as a garage.

The error message disappears if there is sufficient AdBlue® and it has defrosted.

### Selective catalytic reduction system fault

The red  warning lamps light up.

 The instrument cluster display shows a text message **AdBlue® fault! Engine start disabled**.

There is a fault in the selective catalytic reduction system or the system is not filled with standard-compliant AdBlue®.

The yellow indicator lamps  and the alert in the instrument cluster were ignored. It is no longer possible to restart the engine.

- Drive immediately to a suitably qualified workshop without switching off the engine. Volkswagen recommends using a Volkswagen dealership.
- Have the system checked.

### AdBlue® level low

The white  indicator lamp lights up.

AdBlue® is still in the normal operating range.

The remaining range is approximately 2,000 km (around 1,200 miles) or 2,400 km (around 1,500 miles) (depending on equipment).

It is possible to refill AdBlue®, but it is not necessary.



#### AdBlue® level low

The yellow indicator lamp lights up.

The instrument cluster display shows a text message  
Refill AdBlue! No engine start in XXX km (XXX miles).

The remaining range is approximately 1,000 km (600 miles).

1. Refill AdBlue® within the specified distance  
→ page 288.



#### AdBlue® level too low

The red warning lamp lights up.

The instrument cluster display shows a text message  
Refill AdBlue! Engine start disabled.

The AdBlue® level is too low.

The yellow indicator lamp and the alert in the instrument cluster were ignored. It is no longer possible to restart the engine.

1. Park the vehicle.
2. Refill the minimum quantity of AdBlue®  
→ page 288.



The emissions may have a sulphur-like smell even if the emission purification system is working properly.

## Particulate filter

Please refer to and on page 283 and at the start of the chapter on page 286.

### Function

The particulate filter (depending on the vehicle equipment) filters out soot particles in the exhaust gas.

### Regeneration

In normal vehicle operation, the filter cleans itself. If it is not possible for the filter to clean itself, for example if the vehicle is only ever used for short trips, the filter will become saturated with soot. The diesel particulate filter requires cleaning (regeneration).

Noises, slight smells and increased engine speeds may occur during regeneration. The radiator fan may run on while the vehicle is moving or when the engine has been switched off.

To assist the regeneration of the particulate filter, Volkswagen recommends that you avoid making only short journeys.



The soot in the particulate filter is burnt off at high temperatures on a periodic basis. During the periodic regeneration process, the yellow indicator lamp does not light up.

## Catalytic converter

Please refer to and on page 283 and at the start of the chapter on page 286.

Observe the following information to help ensure the long-term functionality of the exhaust system and the catalytic converter in the petrol engine:

- Only use fuel that has been approved for the vehicle.
- Do not run the fuel tank empty → page 285.
- Do not overfill engine oil → page 316.
- Do not tow-start the vehicle. Use jump leads → page 303.

If you notice misfiring, loss of power or uneven running when driving, reduce speed immediately and have the vehicle checked by a correspondingly qualified workshop → page 290. Volkswagen recommends using a Volkswagen dealership. Otherwise unburned fuel can enter the exhaust system and escape into the atmosphere. The catalytic converter can also be damaged by overheating.

## Troubleshooting

Please refer to and on page 283 and at the start of the chapter on page 286.

### Irregular engine running and faults

Irregular engine running or faults when driving may be a sign of poor fuel quality.

1. Reduce speed immediately.
2. Drive to the nearest correspondingly qualified workshop at medium engine speeds and low loads on the engine. Volkswagen recommends using a Volkswagen dealership.
3. If these symptoms occur immediately after refuelling, switch off the engine immediately to avoid any subsequent damage.
4. Seek expert assistance.



### Particulate filter clogged with soot

The indicator lamp lights up yellow.

The particulate filter is saturated with soot and requires regeneration.

Prerequisite for regeneration trip: the engine is at operating temperature.

#### For petrol engines

1. Drive at a speed of at least 80 km/h (50 mph).
2. To allow the vehicle to coast while a gear is engaged, take your foot off the accelerator completely for a few seconds.
3. Repeat this procedure (accelerate and coast) until the indicator lamp goes out.
4. If the indicator lamp does not go out after some time, go immediately to a correspondingly qualified workshop. Volkswagen recommends using a Volkswagen dealership.

#### For diesel engines

1. Drive at a speed of at least 60 km/h (37 mph) with an engine speed of at least 2,000 rpm.  
The achieved temperature increase can burn the soot off the filter.
2. End the regeneration drive only when the indicator lamp goes out.
3. Go to a correspondingly qualified workshop if the indicator lamp continues to light up after driving for approximately 40 minutes. Volkswagen recommends using a Volkswagen dealership.



### Emissions-relevant fault

The indicator lamp lights up yellow.

Fault in an emissions-relevant component that can damage the vehicle.

1. Go to a correspondingly qualified workshop and have the engine and exhaust system checked. Volkswagen recommends using a Volkswagen dealership.



### Misfiring

The indicator lamp flashes yellow.

Misfiring is occurring that can damage the vehicle.

1. Go to a correspondingly qualified workshop and have the engine and exhaust system checked. Volkswagen recommends using a Volkswagen dealership.



### WARNING

Any sudden driving manoeuvres that cannot be anticipated by other road users may lead to accidents.

- Ensure that your speed and driving style are always appropriate for the current visibility, weather and road/traffic conditions.
- Always observe the applicable country-specific traffic regulations.



There may be engine faults and fuel consumption may be higher if the indicator lamps are lit up or flashing.



# If and when

## Vehicle toolkit

### Introduction to the topic

Observe any country-specific legislation when securing your vehicle in the event of a breakdown.

#### WARNING

In the event of a sudden driving or braking manoeuvre or accident, a loose vehicle toolkit, breakdown set and spare wheel or temporary spare wheel could be flung through the vehicle and cause severe injuries.

- Always ensure that the vehicle toolkit, breakdown set and spare wheel or temporary spare wheel are always properly secured in the luggage compartment.

#### WARNING

Unsuitable or damaged tools in the vehicle toolkit can lead to accidents and injuries.

- Never work with unsuitable or damaged tools from the vehicle toolkit.

### Stowage

Please refer to  at the start of the chapter on page 292.

The vehicle toolkit may be located in various places in the vehicle, such as under the luggage compartment floor → page 267 or in a side stowage area of the luggage compartment.

Depending on the equipment level, the luggage compartment may contain a loose box with the vehicle toolkit. This enclosed vehicle toolkit is intended for a possible winter tyre change and does not need to be carried in the vehicle at all times → page 266.

 After using the jack, crank it back to its original position so that it can be stowed safely.

### Contents of the vehicle toolkit

Please refer to  at the start of the chapter on page 292.

The scope of the on-board tool kit depends on the country and equipment. In some countries, there

may also be a tyre pressure gauge in the vehicle. The following describes the maximum content.

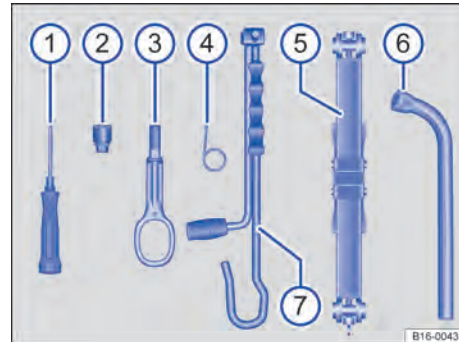

Fig. 203 Contents of the toolbox (illustration).

- ① Screwdriver with hexagon socket in the handle for unscrewing or tightening slackened wheel bolts. The screwdriver blade is reversible. The screwdriver may be stowed under the box spanner.
- ② Adapter for the anti-theft wheel bolt. Volkswagen recommends that you carry the wheel bolt adapter in the vehicle toolkit at all times. The code number of the anti-theft wheel bolt is stamped on the front of the adapter. You will need this number to replace the adapter if it is lost. Make a note of the code number for the anti-theft wheel bolt and keep it in a safe place – but not inside the vehicle.
- ③ Screw-in towing eye.
- ④ Hook for pulling off the centre covers, wheel covers and the wheel bolt caps.
- ⑤ Jack. Before you repack the jack, you must fully wind in the claw.
- ⑥ Box spanner for wheel bolts.
- ⑦ Crank.

#### Servicing the jack

There are no maintenance cycles for the jack.

1. Grease the jack with a universal lubricant when necessary.

## Wiper blades

### Service position

The wiper arms can be lifted off the windscreen when in the service position.

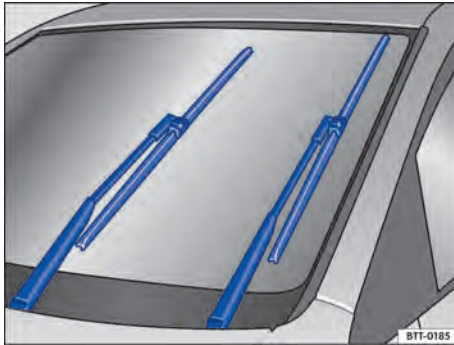

Fig. 204 Wipers in service position (illustration).

#### Activating the service position via the wiper lever

1. Close the bonnet and the driver and front passenger doors.
2. Switch the ignition on and then off again.
3. Press the wiper lever briefly in "flick wipe" direction → page 111.

#### Lifting the windscreen wiper arms

1. Move the wiper arms to the service position before lifting → ①.
2. Hold and lift the wiper arms only in the area of the wiper blade mounting.

#### Placing the wiper arms on the windscreen

1. Before starting your journey, take hold of the wiper arms carefully and only in the area of the wiper blade mounting and place them on the windscreen.
2. Press the wiper lever briefly in "flick wipe" direction with the ignition switched on.

The wiper arms move back to their initial position.

#### ! NOTICE

The bonnet, windscreen and wiper arms can be damaged if the wiper arms are lifted from and placed on the windscreen incorrectly.

- Lift the wiper arms only when in service position.
- Always place the wiper arms back on the windscreen before starting a journey.

#### Cleaning and changing wiper blades

The factory-fitted windscreen wiper blades are coated with graphite. The graphite coating ensures that

the wiper blade moves quietly over the window. If the graphite coating is damaged, the wiper will become louder.

Check the condition of the wiper blades on a regular basis. Wiper blades that rub (judder) should be changed if damaged or cleaned if dirty → ⚠.

Damaged wiper blades should be replaced immediately. Wiper blades are available from a correspondingly qualified workshop. Volkswagen recommends using a Volkswagen dealership.

#### Cleaning wiper blades

*Windscreen wipers:* Move the wiper arms to the service position before lifting → page 292.

1. Lift the wiper arms, making sure that you hold them only in the area of the wiper blade mounting.
2. Clean the wiper blades carefully using a damp sponge → ①.
3. Place the wiper arms carefully back onto the windscreen.

#### Changing the windscreen wiper blades

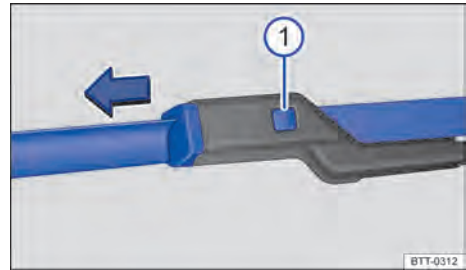
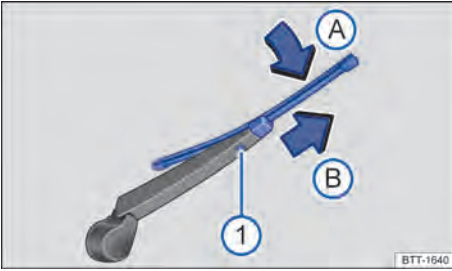

Fig. 205 Changing the windscreen wiper blades.

① Wiper blade release button.

1. Move the wiper arms to the service position before lifting → page 292.
2. Lift the wiper arms, making sure that you hold the wiper arms **only** in the area of the wiper blade mounting.
3. Press and hold the release button and simultaneously pull off the wiper blade in the direction of the arrow → Fig. 205 ①.
4. Insert a new wiper blade with the same length and design onto the wiper arm. Push it on until it engages.
5. Place the wiper arms carefully back onto the windscreen.

## Changing the wiper blade for the rear window



**Fig. 206** Changing the wiper blade for the rear window.

1. Wiper blade release button.
1. When lifting a wiper arm, hold it only in the area of the wiper blade mounting.
2. Lift and fold back the wiper arm.
3. Press and hold the release button → Fig. 206 ①.
4. Tilt the wiper blade in the direction of the wiper arm → Fig. 206 (A) and pull it off in the direction of the arrow (B) at the same time. You may need to use some force to do this.
5. Insert a new wiper blade with the same length and design onto the wiper arm against the direction of the arrow → Fig. 206 (B). The wiper blade must be in folded-down position to do this → Fig. 206 (A).
6. Carefully place the wiper arm back onto the rear window.

### **⚠ WARNING**

Worn or dirty windscreen wiper blades reduce visibility and increase the risk of accidents and severe injuries.

- Always change windscreen wiper blades if they are damaged or worn and no longer clean the windscreen properly.

### **📌 NOTICE**

Damaged or dirty wipers can scratch the windows.

- Do not use any detergents containing solvents, hard sponges or other sharp objects, as they can damage the graphite coating of the wiper blades during cleaning.
- Do not use fuel, nail varnish remover, paint thinner or similar fluids to clean the windows.

**i** Wax deposits on the windscreen and rear window could cause the wiper blades to rub. Re-

move wax residue using a special cleaning product or cleaning cloths. ◀

## Exterior lighting

### **📖 Introduction to the topic**

Before changing a bulb, check whether a bulb or LED light unit has failed. You can normally change bulbs yourself. If the exterior lighting is realised using LED technology, depending on model and vehicle equipment, it is not possible for you to change the LED light units or individual LEDs yourself. If individual LEDs fail, this may be an indication that more LEDs are on the point of failure. In this case, have the LED light units checked and renewed if necessary at a correspondingly qualified workshop. Volkswagen recommends using a Volkswagen dealership.

It may be illegal to drive with faulty exterior lights.

### **Additional bulb specifications**

Some bulbs might have factory specifications that differ from standard bulbs. The designation is inscribed on the bulb, either on the glass part or on the base.

### **⚠ WARNING**

Accidents can occur if roads are not sufficiently illuminated and other road users have difficulty seeing the vehicle, or cannot see it at all.

### **⚠ WARNING**

Changing bulbs incorrectly can cause accidents and serious injuries.

- Always read and observe the warnings before carrying out work in the engine compartment → page 310. The engine compartment of any motor vehicle is a dangerous area. Serious injuries can be sustained here.
- Please note that halogen bulbs are pressurised and can burst when bulbs are changed.
- Change the defective bulb only once it has cooled down completely.
- Never change a bulb unless you know exactly how to carry this out. If you are uncertain of what to do, have the work carried out by a correspondingly qualified workshop. Volkswagen recommends using a Volkswagen dealership.
- Do not touch the glass part of the bulb with unprotected fingers. When the light is switched on, heat will cause fingerprints to evaporate on



the bulb, which in turn will cause the reflector to "go blind"

- There are sharp-edged parts on the headlight housing and on the tail light cluster housing. Protect your hands when changing bulbs.

### ! NOTICE

If water enters the headlight housing, it can cause damage to the electrical system.

- Always fit the covers on the headlight housing after changing bulbs.
- Always check that the covers are fitted correctly. <

## Information on changing bulbs

📖 Please refer to ⚠ and ⌚ at the start of the chapter on page 294.

Always carry out the following actions for changing a bulb in the given order → ⚠:

1. Park the vehicle on a firm and level surface at a safe distance from the flow of traffic.
2. Switch on the electronic parking brake → page 191.
3. Switch off the light.
4. Move the turn signal and main beam lever to neutral position.
5. *Vehicles with an automatic gearbox:* Engage the parking lock P → page 147.
6. Switch off the ignition.
7. *Vehicles with a manual gearbox:* Select a gear.
8. Allow the orientation lighting to go out.
9. Leave the defective bulbs to cool down.
10. Check to see if a fuse has visibly blown → page 297.
11. Follow the instructions to change the affected bulb → ⚠.

Always replace bulbs with identical bulbs of the same type. The designation is inscribed on the bulb, either on the glass part or on the base.

Do not touch the glass part of the bulb with unprotected fingers. When switched on, the heat of the bulb would cause the remaining fingerprint to evaporate and be deposited on the reflector. This will impair the light output of the headlight.

12. After changing a bulb, check to ensure that the bulb is working properly.

If the bulb is not working properly, the bulb may not have been inserted properly, may have failed again, or the connector may have been fitted incorrectly.

13. Each time you change a bulb at the front of the vehicle, the headlight settings should be checked by a correspondingly qualified workshop. Volkswagen recommends using a Volkswagen dealership.

### ! WARNING

Ignoring any of the operating guidelines listed for your personal safety can lead to accidents and severe injuries.

- Always follow the actions in the operating guidelines and observe the general safety precautions.

### ! NOTICE

Improper removal and refitting of trim panels and headlights can cause damage to the vehicle's paint and bodywork.

- When removing and refitting the headlight, make sure that the vehicle's paint and bodywork is not damaged. <

## Changing bulbs in the LED headlights

📖 Please refer to ⚠ and ⌚ at the start of the chapter on page 294.

### Preparing to change a bulb

The actions should only be carried out in the specified order:

1. Observe the instructions and perform the steps → page 295.
2. Open the bonnet ⚠ → page 310.

The headlight does not have to be removed when changing the bulb.

### Changing bulbs in the turn signals

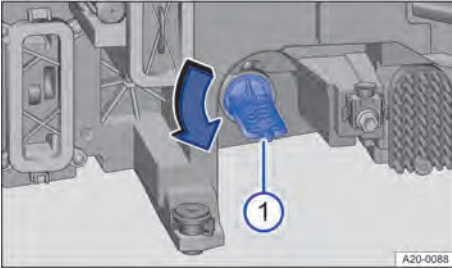

**Fig. 207** In the engine compartment on the right: rear of the headlight.

#### ① Turn signal bulb holder.

1. Turn the bulb holder in the direction of the arrow and pull it out → **Fig. 207 ①**.
2. Replace the defective bulb with a new bulb of the same type.
3. Carefully insert the bulb holder into the headlight and turn it as far as it will go in the opposite direction to the arrow → **Fig. 207 ①**.
4. Close the bonnet **△** → page 310.

**i** The illustration shows the right-hand headlight from the rear. The left-hand headlight is a mirror image of the one shown. **◀**

## Replacing bulbs in the front bumper

**🗉** Please refer to **▲** and **①** at the start of the chapter on page 294.

### Preparations for changing bulbs

The actions should only be carried out in the specified order:

1. Observe and follow the instructions → page 295.
2. Remove the headlights in the front bumper.  
A screwdriver with the requisite blade is needed for the removal process → page 292.

### Changing bulbs in the front bumper (fog lights)

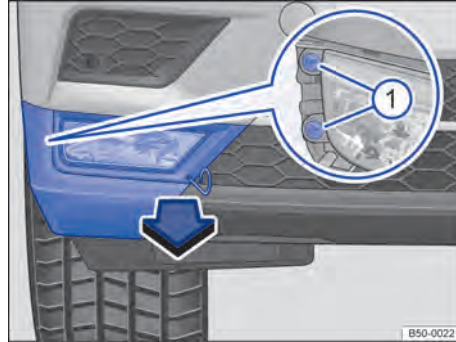

**Fig. 208** In the front bumper on the right: removing the fog light.

#### ① Securing bolts for the fog lights.

1. Attach the hook in the opening on the cover → **Fig. 208**. Pull the cover forwards in the direction of the arrow.
2. Use the screwdriver to unscrew the securing bolts → **Fig. 208 ①**.
3. Pull the headlight out of the bumper towards the outside of the vehicle.
4. Release the connector and pull it off.
5. Turn the bulb holder anti-clockwise as far as it will go and pull it out to the rear together with the bulb.
6. Replace the defective bulb with a new bulb of the same type.
7. Connect the connector to the bulb holder. The connector must audibly click into place → **①**.
8. Insert the bulb holder into the headlight and turn it clockwise as far as it will go.
9. Push the headlight from the outside into the openings and insert into the bumper.
10. Use the screwdriver to screw in the securing bolts → **Fig. 208 ①**.
11. Fit the cover in the bumper → **Fig. 208**.
12. Stow the hook and screwdriver, where applicable, in the vehicle toolkit.

### Changing bulbs in the front bumper Fog lights R-Line



**Fig. 209** In the front R-Line bumper on the right: fog light.

1. Cover for the fog light.

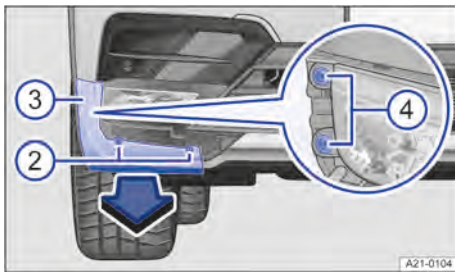

**Fig. 210** In the front R-Line bumper on the right: removing the fog light.

2. Securing bolts for the trim panel.
  3. Trim panel for the fog lights.
  4. Securing bolts for the fog lights.
1. Attach the hook in the opening on the cover under the fog light → Fig. 209. Pull the cover off forwards in the direction of the arrow → Fig. 209 ①.
  2. Use the screwdriver to unscrew the securing bolt in the trim panel → Fig. 210 ② ③.
  3. Unclip the trim panel and remove it in the direction of the arrow → Fig. 210 ③.
  4. Use the screwdriver to unscrew the securing bolts in the fog lights → Fig. 210 ④.
  5. Pull the headlight out of the bumper towards the outside of the vehicle.
  6. Release the connector and pull it off.
  7. Turn the bulb holder anticlockwise as far as it will go and pull it out to the rear together with the bulb.

8. Replace the defective bulb with a new bulb of the same type.
9. Insert the bulb holder into the headlight and turn it clockwise as far as it will go.
10. Connect the connector to the bulb holder. The connector must audibly click into place → ①.
11. Push the headlight from the outside into the openings and insert into the bumper.
12. Use the screwdriver to screw in the securing bolts in the fog lights → Fig. 210 ④.
13. Insert the trim panel into the bumper in the opposite direction to the arrow → Fig. 210 ③. The trim panel must click into place securely.
14. Use the screwdriver to tighten the securing bolts in the trim panel → Fig. 210 ② ③.
15. Insert the cover into the bumper in the opposite direction to the arrow. The cover must click into place securely → Fig. 209 ①.
16. Stow the hook and screwdriver, where applicable, in the vehicle toolkit.

#### ! NOTICE

Improper removal and installation of trim panels and headlights may result in damage to the vehicle paintwork and body.

- When removing and refitting the headlight, make sure that the vehicle's paintwork and body are not damaged.

#### ! NOTICE

If water gets into the electrical connectors, this may cause damage to the electrical system.

- Make sure that the electrical connectors are positioned correctly in the headlight housing when plugging them into the bulb holders.

## Changing fuses

### Introduction to the topic

At the time of publication we are unable to provide an complete overview of the locations of the fuses for the electrical consumers. This is because the vehicle is under constant development, because fuses are assigned differently depending on the vehicle equipment level and because several electrical consumers may use a single fuse. You can get more information about the fuse layout from a correspondingly qualified workshop. Volkswagen recommends using a Volkswagen dealership.

Several electrical consumers can share a single fuse. Conversely, a single consumer could have more than one fuse.

Therefore fuses should only be replaced when the cause of the fault has been rectified. If a new fuse blows again shortly after fitting, have the electrical system checked by a correspondingly qualified workshop as soon as possible. Volkswagen recommends using a Volkswagen dealership.

### **⚠ WARNING**

High voltages in the electrical system can cause electric shocks, serious burns and death.

- Never touch the electrical wiring of the ignition system.
- Avoid causing short circuits in the electrical system.

### **⚠ WARNING**

Using unsuitable or repaired fuses and bridging an electrical circuit without fuses can cause a fire and serious injuries.

- Never fit fuses that have a higher fuse rating.
- Replace fuses only with fuses with the same rating and size. Make sure that the colour and markings are identical to the defective fuse.
- Never repair fuses.
- Never use a metal strip, paper clip or similar objects to replace a fuse.

### **ⓘ NOTICE**

To avoid damage to the electrical system in the vehicle, switch off the ignition, the lights and all electrical consumers before changing a fuse.

- Make sure that it is not possible to switch on the ignition when changing a fuse.

### **ⓘ NOTICE**

You can damage another location in the electrical system by using a fuse with a higher amp rating.

### **ⓘ NOTICE**

Dirt and moisture in the fuse boxes can damage the electrical system.

- Protect open fuse boxes against the ingress of dirt and moisture.

### **ⓘ NOTICE**

Observe the following in order to avoid damage to the vehicle:

- Carefully remove the fuse box covers and fit them correctly again after completing work.

**i** There are other fuses in the vehicle in addition to those described in this chapter. These should be changed only by a correspondingly qualified workshop. Volkswagen recommends using a Volkswagen dealership. <

## **Fuses in the engine compartment**

**ⓘ** Please refer to **⚠** and **ⓘ** at the start of the chapter on page 297.

### **Opening the fuse box in the engine compartment**

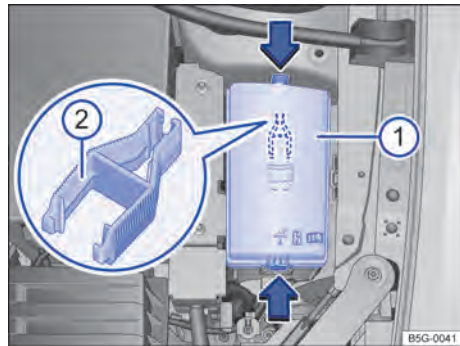

**Fig. 211** In the engine compartment: fuse box.

- ① Fuse box cover.
- ② Plastic grippers for pulling out fuses.

In some vehicles, a pair of plastic pliers → Fig. 211 ② for removing fuses is located on the inside of the cover of the fuse box or on the fuse carrier.

### **Removing the cover**

1. Open the bonnet **⚠** → page 310.
2. Press the catches in the direction of the arrow → Fig. 211 ① to release the fuse box cover.
3. Lift off the cover.

### **Installing the cover**

1. Place the cover on the fuse box.
2. Press the cover down until the cover audibly engages into position on both sides. <

## Fuse tables for fuses in the engine compartment

Please refer to ▲ and ❶ at the start of the chapter on page 297.

The list shows the fuse locations of the electrical consumers relevant for the driver. The first column in the table contains the location. The other columns contain the fuse types, the amp rating and the consumer protected by the fuse.

Depending on the market and specification of your vehicle, the fuse numbers and locations may differ to those given in the table. If necessary, ask a correspondingly qualified workshop for the exact fuse layout. Volkswagen recommends using a Volkswagen dealership.

### Fuse assignment

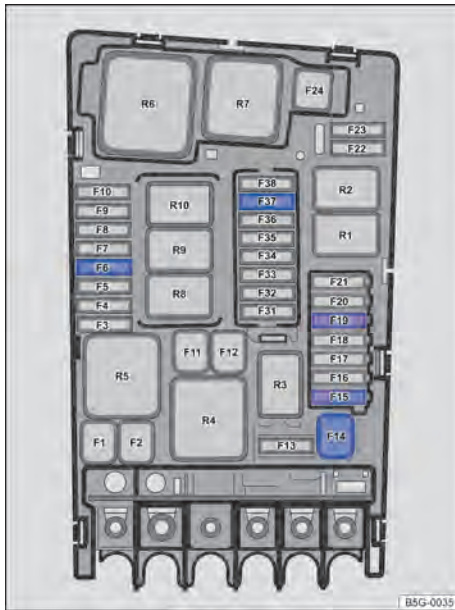

Fig. 212 In the engine compartment: fuse locations.

Fuse location → Fig. 212:

- F6** 7.5 amps, ATO®, brake light sensor.
- F14** 40 amp, cartridge fuse, JCASE®, windscreen heating.
- F15** 15 amps, ATO®, horn.
- F19** 30 amps, ATO®, front wipers.
- F37** 20 amps, ATO®, auxiliary heater.

## Fuses in the dash panel

Please refer to ▲ and ❶ at the start of the chapter on page 297.

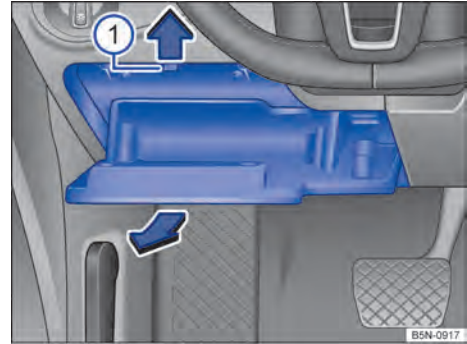

Fig. 213 To the left of the steering wheel: fuse box cover in the dash panel (left-hand drive vehicle).

- ❶ Seat stop for the storage compartment.

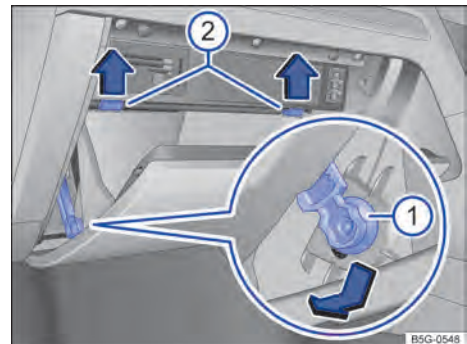

Fig. 214 On the front passenger side: fuse box cover in the dash panel (right-hand drive vehicle)

- ❶ Restrictor.
- ❷ Catches.

**Left-hand drive vehicle: opening and closing the fuse box in the dash panel**

### Removing the cover

1. Open the stowage compartment on the driver side and remove the contents if necessary → Fig. 213.

2. Push the stop upwards and open and pull out the stowage compartment on the driver side in the direction of the arrow → Fig. 213 ①.

### Installing the cover

1. Press the stowage compartment into the mounts on the dash panel until it audibly clicks into place on both sides.
2. Close the stowage compartment on the driver side slightly. If required, push the stop upwards → Fig. 213 ①.

### Right-hand drive vehicle: opening and closing the fuse box in the dash panel

#### Removing the cover

1. Open the glove box and empty if necessary.
2. Push restrictor in the direction of the arrow into the opening of the holder and pull out to the side → Fig. 214 ①.
3. Push catches upwards in the direction of the arrow at the same time open the stowage compartment further → Fig. 214 ②.

#### Installing the cover

1. Move stowage compartment into position.
2. Insert the restrictor into the opening in the holder and slide upwards in the opposite direction to the arrow → Fig. 214 ① until it engages audibly.
3. Carefully push the stowage compartment forwards beyond the resistance of the catches → Fig. 214 ②.

## Fuse table for fuses in the dash panel

📖 Please refer to ▲ and ① at the start of the chapter on page 297.

The list shows the fuse locations of the electrical consumers relevant for the driver. The first column in the table contains the location. The other columns contain the fuse types, the amp rating and the consumer protected by the fuse.

Depending on the market and specification of your vehicle, the fuse numbers and locations may differ to those given in the table. If necessary, ask a correspondingly qualified workshop for the exact fuse layout. Volkswagen recommends using a Volkswagen dealership.

### Fuse assignment

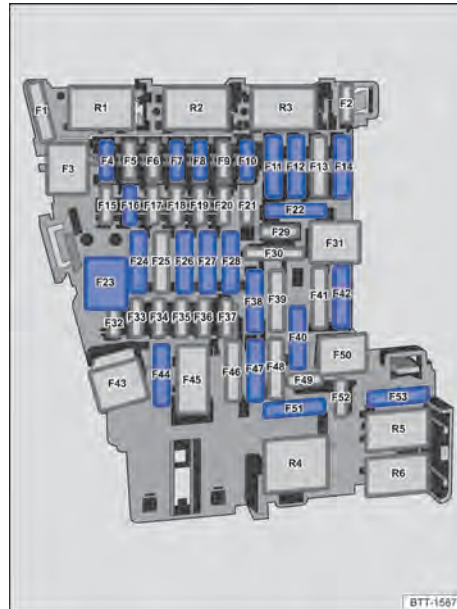

Fig. 215 In the dash panel: fuse assignment.

Fuse locations → Fig. 215:

- F4** 7.5 amps, MINI®, anti-theft alarm.
- F6** 10 amps, ATO®, selector mechanism for automatic gearbox.
- F7** 10 amps, MINI®, air conditioning system control panel or heating and fresh air system, rear window heating relay.
- F8** 7.5 amps, MINI®, light switch for lighting, rain and light sensor, electronic parking brake.
- F10** 7.5 amps, MINI®, display, Infotainment system control panel.
- F11** 40 amps, ATO®, left exterior lighting.
- F12** 20 amps, ATO®, Infotainment system.
- F14** 40 amps, ATO®, blower regulator.
- F16** 7.5 amps, MINI®, telephone.
- F23** 20 amp, cartridge fuse, JCASE® electric glass roof.
- F24** 40 amps, ATO®, right exterior lighting.
- F26** 30 amps, ATO®, seat heating.
- F27** 30 amps, ATO®, interior lighting.
- F40** 20 amps, ATO®, cigarette lighter, sockets. Please note installation position, factory-fitted fuse location as shown in the illustration.
- F42** 40 amps, ATO®, central locking.



- F47 15 amps, ATO<sup>®</sup>, rear window wiper.
- F51 25 amps, ATO<sup>®</sup>, rear seat heating.
- F53 30 amps, ATO<sup>®</sup>, rear window heating.

Fuse locations for vehicles with factory-fitted towing bracket:

- F22 15 amps, ATO<sup>®</sup>, trailer charging cable.
- F28 25 amps, ATO<sup>®</sup>, left trailer control unit.
- F38 25 amps, ATO<sup>®</sup>, right trailer control unit.
- F44 15 amps, ATO<sup>®</sup>, trailer control unit.

 Electric windows and electrically adjustable seats may be protected by **circuit breakers** or **control units** which switch on again automatically a few seconds after the overload, e.g. frozen windows, has been rectified.

## Changing blown fuses

 Please refer to  and  at the start of the chapter on page 297.

### Preparations

1. Switch off the ignition, the lights and all electrical consumers.

### Detecting a blown fuse

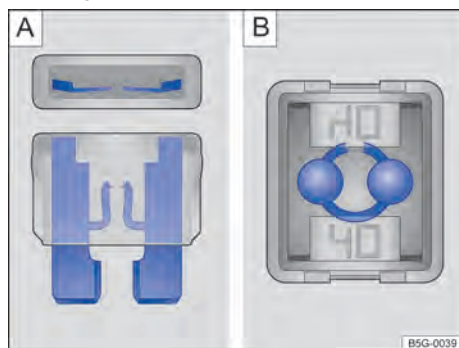



Fig. 216 Blown fuse (illustration).

- If a *flat blade fuse* (ATO<sup>®</sup>, MINI<sup>®</sup>) has blown, this can be recognised from the top and side through the transparent housing due to the melted metal strip → Fig. 216 .
- If a *cartridge fuse* (JCASE<sup>®</sup>) has blown, this can be recognised from the top through the transparent housing due to the melted metal strip → Fig. 216 .

### Fuse types

- Standard flat blade fuse (ATO<sup>®</sup>).
- Small flat blade fuse (MINI<sup>®</sup>).
- Cartridge fuse (JCASE<sup>®</sup>).

### Colour coding of fuses

#### Fuses (ATO<sup>®</sup> - MINI<sup>®</sup>).

*Colour Amp rating*

- Black** 1 amp
- Purple** 3 amps
- Orange** 5 amps
- Brown** 7.5 amps
- Red** 10 amps
- Blue** 15 amps
- Yellow** 20 amps
- White or clear** 25 amps
- Green** 30 amps
- Light green** 40 amps

#### Fuses (cartridge, JCASE<sup>®</sup>)

- Blue** 20 amps
- Pink** 30 amps
- Green** 40 amps
- Red** 50 amps
- Yellow** 60 amps

### Changing fuses

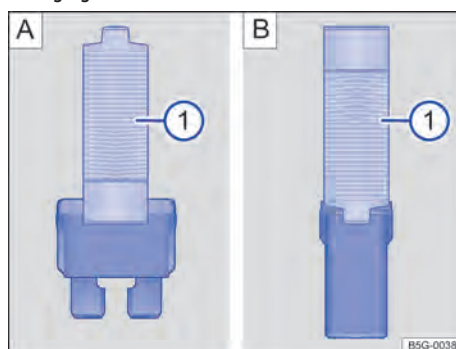



Fig. 217 Removing or inserting fuse with plastic grippers (illustration).

#### Plastic grippers.

1. If applicable, take the plastic grippers out of the fuse box or the cover of the respective fuse box → Fig. 217 .

2. Push the plastic grippers clip suitable for the fuse design onto the fuse from the top or the side → Fig. 217.
3. Remove the fuse.
4. If the fuse has blown, replace it with a new fuse of the *same* amp rating (same colour and same markings) and *same* size → ⓘ.
5. Once the new fuse has been inserted, put the plastic grippers back in the cover.
6. Insert the cover again or close the fuse box cover.

### ⓘ NOTICE

You can damage another location in the electrical system by using a fuse with a higher amp rating. <

## Jump starting

### 📖 Introduction to the topic

For technical reasons, your vehicle may not be push-started → ⓘ.

If the engine fails to start because the 12-volt vehicle battery is flat, the discharged battery can be connected to the 12-volt battery of another vehicle to start the engine.

Suitable jump leads are needed for jump starting.

Cable cross-section for the jump leads:

- For vehicles with a petrol engine at least 25 mm<sup>2</sup> (0.038 in<sup>2</sup>).
- For vehicles with a diesel engine at least 35 mm<sup>2</sup> (0.054 in<sup>2</sup>).

In vehicles with the 12-volt vehicle battery in the luggage compartment, the jump leads must be connected only to the designated jump-start connection points in the engine compartment.

### ⚠ WARNING

Using the jump leads incorrectly or completing the jump start procedure incorrectly can cause the 12-volt vehicle battery to explode, which can lead to severe injuries. Please note the following in order to reduce the risk of the 12-volt vehicle battery exploding:

- Always read and observe the warnings and safety information before carrying out any kind of work on the 12-volt vehicle battery → page 322.
- Please note that the vehicle battery providing assistance must have the same voltage

(12 volts) and approximately the same capacity as the flat 12-volt vehicle battery (see label on battery).

- Never confuse the positive battery terminal with the negative battery terminal or connect the jump leads incorrectly.
- Position the jump leads so that they never come into contact with any moving parts in the engine compartment.
- Observe the operating instructions provided by the jump lead manufacturer.
- Observe the owner's manual of the vehicle providing jump starting assistance.

### ⚠ WARNING

A highly explosive mixture of gases is given off when the 12-volt vehicle battery is jump started.

- Always keep fire, sparks, naked flames and lit cigarettes away from the 12-volt vehicle battery.
- Never use a mobile telephone when the jump leads are being connected or disconnected.

### ⓘ NOTICE

Discharged 12-volt vehicle batteries can already freeze at temperatures of around 0°C (+32°F).

- Never charge a 12-volt vehicle battery which is frozen or has been frozen.
- Always replace a 12-volt vehicle battery which is frozen or has been frozen.

### ⓘ NOTICE

Please note the following in order to avoid considerable damage to the vehicle electrical system:

- A short circuit can be caused if the jump leads are wrongly connected.
- The vehicles must not touch each other, as any contact could mean that electricity could flow as soon as the positive battery terminals are connected.
- Use only jump leads with fully insulated terminal clamps.

### ⓘ NOTICE

Tow-starting the vehicle can cause damage. <



## Jump-start connection point (earth connection)

📖 Please refer to ⚠️ and ⌚ at the start of the chapter on page 302.

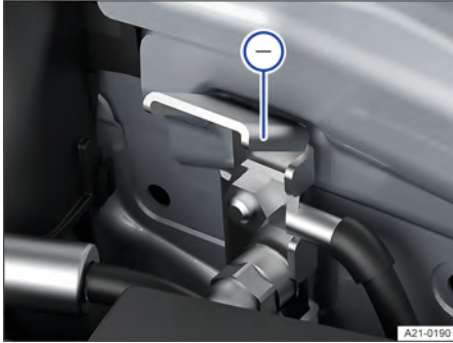

**Fig. 218** In the engine compartment: jump-start connection point (earth connection).

⊖ The jump-start connection point (earth connection) is used for connecting the *black* jump lead → Fig. 218.

The vehicle can only be jump started via this jump-start connection point (earth connection).

## Jump-start connection point (positive battery terminal)

📖 Please refer to ⚠️ and ⌚ at the start of the chapter on page 302.

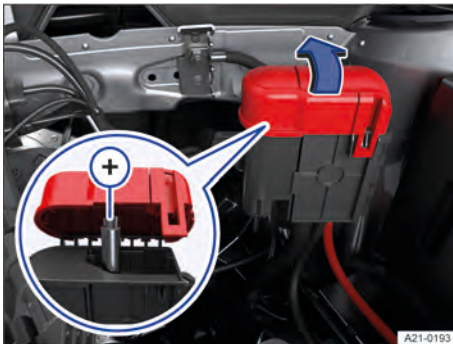

**Fig. 219** In the engine compartment underneath a cover: jump-start connection point (positive battery terminal).

⊕ In vehicles with a 12-volt vehicle battery in the luggage compartment, there is a jump-start connection point (positive terminal) under a cover in the engine compartment for connecting the *red* jump lead.

The vehicle can be jump-started or be used to jump-start another vehicle via this jump-start connection point (positive battery terminal).

## Jump starting the vehicle

📖 Please refer to ⚠️ and ⌚ at the start of the chapter on page 302.

### Preparations

1. The discharged 12-volt vehicle battery must be properly connected to the vehicle electrical system.
2. If the vehicle is fitted with a 12-volt vehicle battery with a battery window, check the colour of the window → page 323. If the window is light yellow or colourless, do not jump start the vehicle. Seek expert assistance.
3. Make sure that the vehicles do not touch. Otherwise electricity could flow as soon as the positive battery terminals are connected.
4. Ensure that the battery clamps have good metal-to-metal contact with the battery terminals.
5. If the engine does not start immediately, switch off the starter after about 10 seconds and try again after about 1 minute.
6. If the engine still does not start, seek expert assistance.

### ⚠️ NOTICE

Observe the instructions for jump starting in the owner's manual of the other vehicle.

**Connecting jump leads (vehicles with 12-volt battery in the engine compartment)**

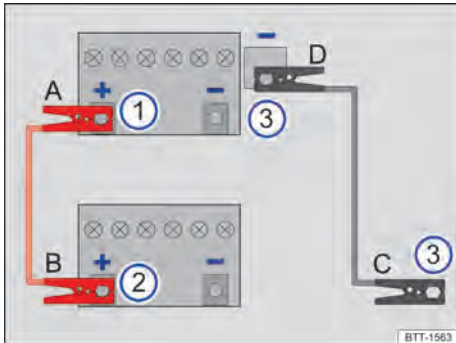

**Fig. 220** Diagram for connecting the jump leads (12-volt vehicle battery in the engine compartment).

- ① Vehicle with discharged 12-volt vehicle battery that is being jump-started.
- ② Vehicle with 12-volt vehicle battery that is supplying power and jump-starting the other vehicle.
- ③ Suitable earth connection: preferably the earth connection jump-start connection point (-), a solid metal part which is securely bolted onto the cylinder block, or the cylinder block itself.

The jump leads should be connected only in the order **A - B - C - D** → Fig. 220.

The *black* jump lead should never be connected to the negative terminal (-) on the 12-volt vehicle battery. Connecting the lead to the negative terminal can cause incorrect condition evaluation of the 12-volt vehicle battery in the vehicle electronics.

1. Switch off the ignition in both vehicles → page 138.
2. Open the cover on the 12-volt vehicle battery in the engine compartment, if a cover is installed → page 322.
3. Connect one end of the *red* jump lead **A** to the positive battery terminal (+) of the battery on the vehicle with the discharged 12-volt vehicle battery → Fig. 220 ① → ▲.
4. Connect the other end of the *red* jump lead **B** to the positive battery terminal (+) of the vehicle providing assistance → Fig. 220 ②.
5. Connect one end of the *black* jump lead **C** preferably to an earth connection jump-start connection point (-), or otherwise to a solid metal part that is securely bolted onto the cylinder

block, or to the cylinder block itself of the vehicle providing assistance → Fig. 220 ③.

6. Connect the other end of the *black* jump lead **D** on the vehicle with the 12-volt discharged vehicle battery preferably to the earth connection jump-start connection point (-), or otherwise to a solid metal part that is securely bolted onto the engine block or to the engine block itself → Fig. 220 ③ → ▲.
7. Position the leads in such a way that they cannot come into contact with any moving parts in the engine compartment.

**Connecting jump leads (vehicles with 12-volt battery in the luggage compartment)**

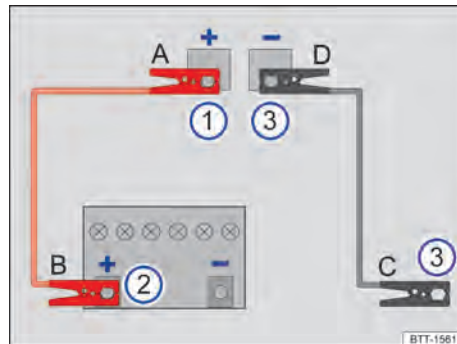

**Fig. 221** Diagram for connecting the jump leads (12-volt vehicle battery in the luggage compartment).

- ① Vehicle with discharged 12-volt vehicle battery that is being jump-started.
- ② Vehicle with 12-volt vehicle battery that is supplying power and jump-starting the other vehicle.
- ③ Suitable earth connection: preferably the earth connection jump-start connection point (-), a solid metal part which is securely bolted onto the cylinder block, or the cylinder block itself.

The jump leads should be connected only in the order **A - B - C - D** → Fig. 221.

1. Switch off the ignition in both vehicles → page 138.
2. Fold open the cover of the jump-start connection point in the engine compartment → page 303.
3. Connect one end of the *red* jump cable **A** to the jump lead positive (+) of the vehicle with the discharged 12-volt vehicle battery → Fig. 221 ① → ▲.

4. Connect the other end of the *red* jump lead **B** to the positive battery terminal (+) of the vehicle providing assistance → Fig. 221 ②.
5. On the vehicle with the 12-volt vehicle battery providing assistance, connect one end of the *black* jump lead **C** preferably to an earth connection jump-start connection point (-), or otherwise to a solid metal part that is securely bolted onto the cylinder block, or to the cylinder block itself → Fig. 221 ③.
6. Connect the other end of the *black* jump lead **D** on the vehicle with the 12-volt discharged vehicle battery preferably to the earth connection jump-start connection point (-), or otherwise to a solid metal part that is securely bolted onto the engine block or to the engine block itself → Fig. 221 ③ → ⚠.
7. Position the leads in such a way that they cannot come into contact with any moving parts in the engine compartment.

Vehicles with a 12-volt vehicle battery in the luggage compartment can be used to jump start another vehicle via the positive battery terminal jump-start connection point (+) and earth connection jump-start connection point (-).

#### Starting the engine

1. Start the engine of the vehicle providing assistance and let it run at idle.
2. Start the engine of the vehicle with the discharged 12-volt vehicle battery and wait two or three minutes until the engine is running "smoothly".

#### Removing the jump leads

1. Before disconnecting the jump leads, switch off the dipped beam headlights, if switched on.
2. Turn on the blower of the air conditioning system or the heating and fresh air system and the rear window heating in the vehicle with the discharged 12-volt vehicle battery. This helps to minimise voltage peaks which are generated when the leads are disconnected.
3. When the engine is running, the jump leads should be removed only in the order **D – C – B – A** → Fig. 220 or → Fig. 221.
4. If necessary, close the battery cover or fold back the cover of the jump-start connection point → page 303.
5. After jump starting, have the 12-volt vehicle battery checked by a correspondingly qualified workshop. Volkswagen recommends using a Volkswagen dealership.

#### ⚠ WARNING

Jump starting the vehicle incorrectly can cause the 12-volt vehicle battery to explode, which can lead to serious injuries. Please note the following in order to reduce the risk of the 12-volt vehicle battery exploding:

- Always wear suitable eye protection and gloves and never lean over the 12-volt vehicle battery.
- Attach the connecting cables in the correct order – the positive cable first, followed by the negative cable.
- Never connect the negative lead to parts of the fuel system or to the brake lines.
- Do not allow the uninsulated parts of the terminal clamps to touch each other.
- Do not allow leads attached to the positive battery terminal on the 12-volt vehicle battery to touch electrically conductive parts of the vehicle.
- Avoid electrostatic discharge in the vicinity of the 12-volt vehicle battery. The explosive gas emitted from the 12-volt vehicle battery could be ignited by sparks.
- Do not perform jump starting if the 12-volt vehicle battery is damaged or if it is frozen or has been frozen.

#### ⓘ NOTICE

After jump starting, have the 12-volt vehicle battery checked by a correspondingly qualified workshop. Volkswagen recommends using a Volkswagen dealership.

## Towing

### 📖 Introduction to the topic

Towing requires experience, especially when using a tow-rope. Both drivers should be familiar with the technique required for towing. Inexperienced drivers should not attempt to tow.

Observe any legal requirements when towing.

Make sure that no excessive pulling forces occur and take care to avoid jerking movements. When towing offroad, there is always a risk of overloading the anchorage points.

#### Towing

Towing is where a vehicle that cannot be driven is pulled with the aid of another vehicle.

The vehicle can be towed with a tow-bar or a tow-rope:

- The maximum permitted towing speed is 50 km/h (30 mph).
- The maximum permitted distance is 50 km (30 miles).

It is easier and safer to tow a vehicle with a tow-bar. Use a tow-rope only if you do not have a tow-bar.

The tow-rope should be slightly elastic to reduce the strain on both vehicles. It is advisable to use a tow-rope made of synthetic fibre or similarly elastic material.

#### Towing with a breakdown truck

If one of your vehicle's axles is to be raised for towing, then which axle depends on the gearbox and drive combination. Only the following axles must be used:

Front-wheel drive

**Automatic gearbox** Front axle

**Manual gearbox** Front axle

All-wheel drive 4MOTION

**Automatic gearbox** Front axle

**Manual gearbox** Front axle

In the case of R models, the vehicle must not be towed with a raised axle and must be transported standing on all four wheels on a recovery vehicle in case of damage → ⓘ.

#### ⚠ WARNING

If a vehicle is being towed, the vehicle handling and braking efficiency will change significantly.

#### ⚠ WARNING

Never tow a vehicle that has no power supply.

- Never switch off the ignition using the starter button when the vehicle is being towed. Otherwise the electronic steering column lock could engage suddenly. You will no longer be able to steer the vehicle. This can lead to a loss of control of the vehicle, accidents and serious injuries.
- Never remove the vehicle key from the ignition lock during towing. Otherwise, the mechanical steering column lock or steering lock could suddenly engage. You will no longer be able to steer the vehicle. This can lead to a loss of control of the vehicle, accidents and serious injuries.
- If the power supply of the towed vehicle fails, stop towing immediately and seek expert assistance.

#### ⓘ NOTICE

Towing vehicles with 4MOTION all-wheel drive and sport differential with a raised axle can damage the vehicle.

- Have the broken-down vehicle transported only on a recovery vehicle standing on all four wheels.

#### ⓘ NOTICE

Towing with a tow-rope or tow-bar can damage the vehicle.

- Tow the vehicle carefully with a tow-rope or tow-bar.
- If possible, have the broken-down vehicle transported by a recovery vehicle.

#### ⓘ NOTICE

When pushing the vehicle by hand, the tail light clusters, side spoilers on the rear window and large panels can be damaged and the rear spoiler may become detached.

- When pushing the vehicle by hand, do not press on the tail light clusters, side spoilers on the rear window, large panels and the rear spoiler.

#### ⓘ NOTICE

The vehicle can be damaged, e.g. paintwork, when removing and fitting the cover and towing eye.

- Remove and install the cover and the towing eye carefully so as to avoid damage to the vehicle.

#### ⓘ NOTICE

Use of a towing eye that is not suitable for the vehicle can damage the vehicle.

- Always use the towing eye supplied in the vehicle toolkit of your vehicle or a towing eye that is suitable for the vehicle for towing. ◀

#### Notes on towing

📖 Please refer to ⚠ and ⓘ at the start of the chapter on page 305.

It is still possible to activate the turn signals in a vehicle that is being towed, even if the hazard warning lights are switched on. To do this, operate the turn signal and main beam lever in the required direction while the ignition is switched on. The hazard warning lights will not flash while the turn signal is being used. The hazard warning lights will start flashing again automatically as soon as the turn signal and

main beam lever is moved back to the neutral position.



#### In which situations may the vehicle not be towed?

Do not have the vehicle towed in the following situations:

- The 12-volt vehicle battery is discharged.
- The instrument cluster display does not work properly.
- The distance to be towed is further than 50 km (30 miles).
- In vehicles with a manual gearbox, the clutch cannot be depressed *fully* and neutral selected.
- The selector lever of the automatic gearbox cannot be moved to neutral (N position).
- The electronic parking brake cannot be released.
- The steering column lock cannot be released.
- If the steering function or the operating clearance of the wheels cannot be ensured after an accident.

If the vehicle cannot be towed on its own wheels due to one of the above conditions, seek expert assistance and have the vehicle transported on a recovery vehicle if necessary.

## Towing

📖 Please refer to  and  at the start of the chapter on page 305.

Attach the tow-rope or the tow-bar only to the points provided:

- Towing eye.
- Ball coupling.

#### Preparations

- Ensure that the tow-rope is not twisted. Otherwise a towing eye can become unscrewed during towing.
- Switch on the ignition and hazard warning lights on both vehicles. However, observe any regulations to the contrary.
- Comply with the information on towing contained in the owner's manual for the other vehicle.

#### Pulling vehicle (front)

1. The tow-rope must be taut before you drive off properly.
2. Press the accelerator carefully.
3. Avoid sudden braking and driving manoeuvres.

4. Do not exceed the maximum permitted trailer weight.
5. *In vehicles with a manual gearbox:* engage the clutch particularly gently when moving off.

#### Pulled vehicle (rear)

1. Make sure that the ignition is switched on so that the steering wheel is not locked and you can indicate and operate the wipers if necessary.
2. Release the electronic parking brake.
3. Ensure that the tow-rope is always taut.
4. Disengage the gear.
5. Select "N" selector lever position.

The brake servo and power steering function only when the engine is running. Otherwise you must press the brake pedal with significantly more force and also use more effort for steering.

#### WARNING



Never attach the tow-rope or tow-bar to axle or running gear components. These can be damaged as a result and this can cause accidents and serious injuries.

- Seek expert assistance and have the vehicle transported on a recovery vehicle if necessary.

#### NOTICE

The vehicle can be towed only if the 12-volt vehicle battery is adequately charged, so that the electronic parking brake and the steering column lock can be released. If the power supply fails or if there are faults in the electrical system, you may need to perform jump starting to start the engine or activate the vehicle's drive system in order to release the electronic parking brake and the steering column lock.

## Fitting the towing eye at front

📖 Please refer to  and  at the start of the chapter on page 305.

Depending on the country and vehicle equipment, the mounting for the towing eye is located behind the cover in the bumper.

1. Before towing, check whether the mounting with screw thread is available for the towing eye.
2. If this is not the case, seek expert assistance and have the vehicle transported on a recovery vehicle if necessary.

The towing eye must always be kept in the vehicle.  
Comply with the notes on towing → page 306.

### Fitting the towing eye at front



**Fig. 222** In the front bumper on the right: removing the cover.



**Fig. 223** In the front bumper on the right: removing the cover (R Line).



**Fig. 224** In the front bumper on the right: screwing in the towing eye.

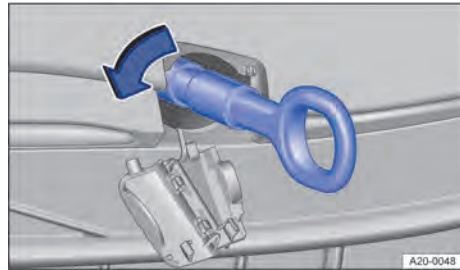

**Fig. 225** In the front bumper on the right: screwing in the towing eye, R Line.

1. Remove the towing eye from the vehicle toolkit in the luggage compartment → page 292.
2. Press the marked area of the cover in the direction of the arrow to release the cover catch → Fig. 222.
3. Remove the cover, allow it to hang on the vehicle or place it in the vehicle if necessary.
4. Turn the towing eye as shown by the arrow into the threaded hole and tighten as far as possible → Fig. 224, → ⓐ. Use a suitable object to screw the towing eye fully and securely into the mounting.
5. After you have finished towing, remove the towing eye by unscrewing it in the opposite direction to the arrow using a suitable object.
6. Insert the cap in the respective recess and press in until it engages.
7. Clean the towing eye if necessary and place it back in the vehicle toolkit in the luggage compartment.

### NOTICE

The towing eye must always be screwed fully and securely into the mounting. Otherwise, the towing eye can be wrenched out of the mounting when the vehicle is being tow-started or towed. <

### Fitting the rear towing eye

📖 Please refer to ⚠ and ⓐ at the start of the chapter on page 305.

Depending on the country and vehicle equipment, the mounting for the towing eye is located behind the cover in the bumper.

1. Before towing, check whether the mounting with screw thread is available for the towing eye.

- If this is not the case, seek expert assistance and have the vehicle transported on a recovery vehicle if necessary.

The towing eye must always be kept in the vehicle.

Comply with the notes on towing → page 306.

#### Fitting the rear towing eye



**Fig. 226** In the rear bumper on the right: removing the cover.



**Fig. 227** In the rear bumper on the right: screwing in the towing eye.

- Remove the towing eye from the vehicle toolkit in the luggage compartment → page 292.
- Press the marked area of the cover in the direction of the arrow to release the cover catch → Fig. 226.
- Remove the cover, allow it to hang on the vehicle or place it in the vehicle if necessary.
- Turn the towing eye as shown by the arrow into the threaded hole and tighten as far as possible → Fig. 227, → ①. Use a suitable object to screw the towing eye fully and securely into the mounting.
- After you have finished towing, remove the towing eye by unscrewing it in the opposite direction to the arrow using a suitable object.
- Insert the cap in the respective recess and press in until it engages.

- Clean the towing eye if necessary and place it back in the vehicle toolkit in the luggage compartment.

#### NOTICE

The towing eye must always be screwed fully and securely into the mounting. Otherwise, the towing eye can be wrenched out of the mounting when the vehicle is being tow-started or towed.

#### Vehicles with towing bracket

In vehicles with a factory-fitted towing bracket there is no mounting for the screw-in towing eye behind the cover.

- In order to tow the vehicle, use the ball coupling. You will first have to swivel it out or fit it → page 273.

#### NOTICE

Vehicles with a factory-fitted towing bracket can be used to tow other vehicles only with a tow-bar that is specially designed to be fitted to a ball coupling. If you use an unsuitable tow-bar, the ball coupling and the vehicle could be damaged.

- Use a tow-rope instead of a tow-bar for towing. <

# Checking and refilling

## In the engine compartment

### Safety notes for working in the engine compartment

The engine compartment of a motor vehicle is a hazardous area. You should only carry out work in the engine compartment if you know exactly how to perform the required tasks, are aware of the general safety procedures and have access to the correct equipment, service fluids and suitable tools. Failing to carry out work correctly can cause serious injuries → ⚠️. Have all work carried out by a correspondingly qualified workshop if necessary. Volkswagen recommends using a Volkswagen dealership.

Always park the vehicle on a level and stable surface before carrying out any work in the engine compartment.

#### ⚠️ WARNING

Unintentional vehicle movements during service work can cause serious injury.

- Never work underneath a vehicle if it is not secured against rolling away. If you are working underneath the vehicle while the wheels are on the ground, the vehicle must be on a level surface and the wheels must be blocked.
- If you are working under the vehicle, use suitable stands to provide support for the vehicle. The jack is not sufficient for this task and can fail, which can lead to serious injuries.
- The start/stop system must be manually deactivated.

#### ⚠️ WARNING

The engine compartment of any motor vehicle is a dangerous area. Serious injuries can be sustained here.

- Always work with extreme care and caution and observe the generally valid safety instructions.
- Never perform any work in the engine compartment unless you know exactly how to carry it out. If you are uncertain of what to do, have the work carried out by a correspondingly qualified workshop. Serious injuries can result from work that has not been carried out properly. Volkswagen recommends using a Volkswagen dealership.
- Never open and close the bonnet as long as steam or coolant is escaping. Hot steam or hot coolant can cause serious burns. Always wait

until you can no longer see or hear steam or coolant coming from the engine compartment.

- Always allow the engine to cool down before opening the bonnet.
- Hot parts of the engine or exhaust system can burn the skin.
- The following must be observed before opening the bonnet:
  - Activate the electronic parking brake and move the selector lever to position **P** or move the gear lever to the neutral position.
  - Switch off the ignition and keep the vehicle key in a safe place far enough away from the vehicle so that, particularly in vehicles with Keyless Access, the ignition cannot be switched on unintentionally and the combustion engine started.
  - Always keep children away from the engine compartment and never leave children unsupervised.
- The cooling system is under pressure when the engine is hot. Never open the cap of the coolant expansion tank when the engine is hot. Coolant may spray out and cause serious burns and other injuries.
  - Turn the cap of the coolant expansion tank slowly and very carefully anticlockwise while exerting slight downwards pressure on the cap.
  - Always protect your face, hands and arms from hot coolant or steam with a large, thick cloth.
- When refilling, do not spill any service fluids onto engine components or onto the exhaust system. The spilt service fluids can start a fire.

#### ⚠️ WARNING

High voltages in the electrical system can cause electric shocks, burns, serious injuries and death!

- Never short circuit the electrical system. The 12-volt vehicle battery could explode.
- To reduce the risk of an electric shock and serious injury while the engine is running or being started, never touch the electrical wiring in the ignition system.
- Never touch the electrical wiring and connections of gas discharge bulbs.

#### ⚠️ WARNING

There are rotating components in the engine compartment that can cause serious injury.



- Never reach into the radiator fan or into the area of the radiator fan. Touching the rotor blades can result in serious injuries. The fan is temperature-controlled and could start automatically - even when the ignition is switched off.
- If any work has to be performed when the engine is started or with the engine running, there is risk of fatal injury from the rotating parts, such as the poly V-belt, alternator and radiator fan, and from the high-voltage ignition system. Always take extreme care.
  - Always ensure that no body parts, jewellery, ties, loose items of clothing or long hair can be caught up in rotating engine components. Before starting work, remove any jewellery and ties, tie up long hair and pull clothes in tightly to avoid them getting caught in engine parts.
  - Always take due care and attention when depressing the accelerator. The vehicle could start moving even if the electronic parking brake is switched on.
- Always ensure you have not left any objects, such as cleaning cloths and tools, in the engine compartment. Any forgotten items can cause malfunctions, engine damage and fires.

### WARNING

Additional insulating materials such as blankets in the engine compartment could disrupt the operation of the engine, start fires and lead to severe injuries.

- Never cover the engine with blankets or other insulating materials.

### WARNING

Service fluids and some materials in the engine compartment are highly flammable and can cause fires and serious injuries!

- Never smoke in the vicinity of the engine compartment.
- Never work near naked flames or sparks.
- Never spill service fluids onto the engine. They could ignite on hot engine components and thus cause injuries.
- Please note the following when carrying out any work on the fuel system or the electrical system:
  - Always disconnect the 12-volt vehicle battery.

Ensure that the vehicle is unlocked when the 12-volt vehicle battery is disconnected as



otherwise the anti-theft alarm will be activated.

- Never work in the direct proximity of heating systems, water heaters or any other naked flames.
- Always have a fully functional and tested fire extinguisher to hand.

### NOTICE

The use of incorrect service fluids could result in serious malfunctions and engine damage.

- When refilling or replacing service fluids, ensure that you pour the correct service fluids into the correct openings.

 Any service fluids leaks from the vehicle are harmful to the environment. You should therefore regularly check the ground underneath your vehicle. If there are patches of oil or other fluids on the ground, the vehicle should be inspected by a suitably qualified workshop. Any spilt service fluids must be disposed of properly. Volkswagen recommends using a Volkswagen dealership. 

## Preparing the vehicle for working in the engine compartment

The following steps should always be carried out in the specified order before working in the engine compartment → :

1. Park the vehicle on a level and stable surface.
2. Depress and hold the brake pedal until the engine has stopped.
3. Switch on the electronic parking brake → page 191.
4. Move the selector lever to position **P** → page 147.
5. Switch off the engine.
6. If necessary, remove the vehicle key from the vehicle and keep in a location outside the vehicle so that the vehicle is not put into operation accidentally.
7. Allow the engine to cool sufficiently.
8. Always keep other persons away from the engine compartment.
9. Secure the vehicle against rolling away.

### WARNING

Ignoring any of the operating guidelines listed for your personal safety can lead to accidents and severe injuries.

- Always follow the actions in the operating guidelines and observe the general safety precautions.

## Opening and closing the bonnet



Fig. 228 In the footwell on the driver side: bonnet release lever (schematic diagram).

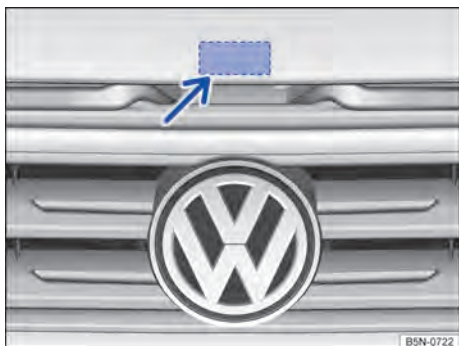

Fig. 229 Above the radiator grille: bonnet control lever.

### Opening the bonnet

1. Open the driver door and pull the release lever in the direction of the arrow → Fig. 228.  
The bonnet jumps out of the lock on the lock carrier → ①.
2. Lift the bonnet, press the control lever and open it fully → Fig. 229.  
The bonnet is held by gas struts.

### Closing the bonnet

1. Pull the bonnet down until the force of the gas struts is overcome → ⚠.

2. Allow the bonnet to drop from a height of about 20 cm (8 in) into the lock in the lock carrier – *do not* press it down!

The bonnet is flush with the body parts around it when it is closed properly → ⚠.

If the bonnet has not closed properly, lift it and then close it again.

The instrument cluster display no longer shows the bonnet highlighted or the display goes out → page 313.

### ⚠ WARNING

If the bonnet is not closed properly, it can open suddenly while you are driving and completely obscure your view of the road. This can lead to accidents and serious injuries.

- After closing the bonnet, always check whether the catch is properly engaged in the lock carrier.
- If you establish while driving that the bonnet is not closed properly, switch on the hazard warning lights, carefully apply the brakes, stop the vehicle as soon as possible and close the bonnet.
- Open or close the bonnet only when there is no one in its movement path.

### ⓘ NOTICE

Opening and closing the bonnet incorrectly can damage the bonnet or the wiper arms.

- Open the bonnet only when the wiper arms are flush to the windscreen and when they are switched off.
- Always fold the wiper arms back onto the windscreen before driving away.

## Display



**Fig. 230** On the instrument cluster display: the bonnet is open or not closed properly (illustration).

A symbol on the instrument cluster display indicates if the bonnet is open or is not closed properly → Fig. 230.

1. Do not drive on!

If necessary, lift the bonnet and then close it again.

This symbol is also visible when the ignition is switched off and will go out a few seconds after the vehicle has been locked when all doors are closed.

### WARNING

Failure to observe warnings can cause your vehicle to break down in traffic, which can lead to accidents and serious injuries.

- Never ignore warnings.
- Stop the vehicle as soon as possible and when safe to do so.



The symbol can differ depending on the version of the instrument cluster.

## Service fluids and consumables

All **service fluids and consumables**, e.g. coolant and batteries, are being constantly developed. This also applies to engine oils in the case of combustion engines. For this reason, service fluids and consumables should be replaced by a correspondingly qualified workshop. Volkswagen recommends using a Volkswagen dealership.

### WARNING

Unsuitable service fluids and consumables, and the incorrect use of these fluids and consumables, can cause accidents, serious injuries, burns or poisoning.

- Store service fluids only in the closed original container.
- Never store service fluids in empty food containers, bottles or any other non-original containers as people finding these containers could drink them.
- Keep children away from all service fluids and consumables.
- Always observe and follow the information and warnings on the service fluid packaging.
- When using products that give off harmful fumes, always work outdoors or in a well-ventilated area.

### NOTICE

The use of incorrect service fluids could result in serious malfunctions and engine damage.

- When refilling or replacing service fluids, ensure that you pour the correct service fluids into the correct openings.



Leaking service fluids can pollute the environment. Spilt service fluids must be collected in suitable containers and disposed of properly and in an environmentally responsible way.

## Washer fluid





**Fig. 231** In the engine compartment: washer fluid reservoir cap (illustration).

The washer fluid level should be checked regularly and refilled as necessary.

There is a strainer in the filler throat of the washer fluid reservoir. The strainer keeps large dirt particles away from the washer jets when refilling. The strainer should only be removed for cleaning. If the strainer is damaged or is not present when refilling, dirt particles can enter the system and block the washer jets.

1. Open the bonnet  → page 312.

The washer fluid reservoir is identified by the  symbol on the cap → Fig. 231.

2. Check whether there is enough washer fluid in the reservoir.
3. To refill, mix clean water, not distilled water, with a commercially available windscreen washer fluid → . Observe the mixture instructions on the packaging.
4. At low outside temperatures, add a special anti-freeze agent so that the fluid cannot freeze → .

The filling quantity of the washer fluid reservoir is approx. 3.0 l to 7.5 l (3.1 qt to 7.9 qt) depending on the vehicle and equipment.

### WARNING

Never mix coolant additive or other unsuitable additives into the washer fluid. These may leave an oily film on the window, considerably restricting the field of vision.

### NOTICE

Never mix suitable cleaning agents with other cleaning agents. This can cause the ingredients to separate and block the washer jets.

## Engine oil

### Introduction to the topic

Engine oils are matched to the requirements of the engines, exhaust purification systems and fuel quality. Due to the way in which a combustion engine works, engine oil always comes into contact with combustion residues and fuel, which has an effect on the ageing process of the oil. The correct engine oil is important for the function and service life of the engine. A special multigrade high-lubricity oil has been filled at the factory and this can normally be used as an all-season oil.

### WARNING

Incorrect handling of engine oil can cause serious burns and other injuries.

- Always wear eye protection when handling engine oil.
- Engine oil is toxic. Always keep engine oil out of the reach of children.
- Store engine oil only in the closed original container. This also applies to used oil until it is disposed of.
- Regular contact with engine oil can damage the skin. Always wash skin that has been in contact with engine oil thoroughly with water and soap.
- Engine oil becomes extremely hot when the engine is running and can scald skin severely. Always allow the engine to cool down.



Leaking or spilt engine oil can pollute the environment. Spilt service fluids must be collected and disposed of properly and with respect for the environment.

## Engine oil standards

 Please refer to  and  on page 310 and  at the start of the chapter on page 314.

### Vehicles with stickers

The sticker showing the prescribed standard is located in the engine compartment → Fig. 232 .

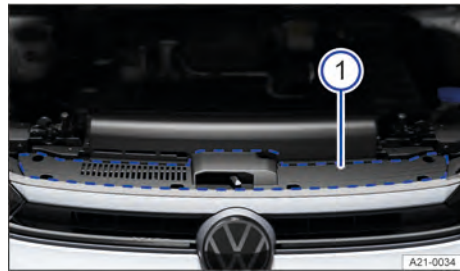
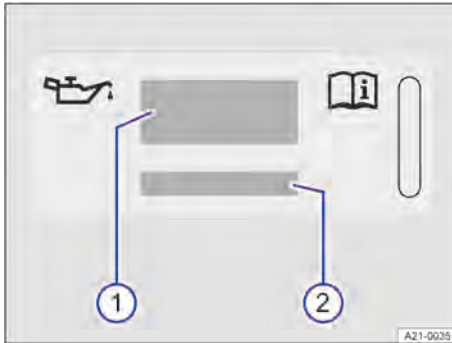

Fig. 232 In the engine compartment: sticker next to the bonnet release (illustration).

- ① Sticker next to the bonnet release.

If you need to fill up the engine oil, use an oil that complies with the engine oil standard on the sticker → Fig. 233.



**Fig. 233** Sticker showing the engine oil standard and engine oil viscosity (illustration).

- ① Information about the engine oil standard.
- ② Information about the engine oil viscosity.

When using this engine oil, you can correct the engine oil level as often as you like → page 316.

#### Vehicles without an engine oil sticker

Information on the prescribed engine oil standard for your vehicle can be obtained from a correspondingly qualified workshop. Use this oil if you need to refill the engine oil. When using the prescribed engine oil, you can correct the engine oil level as often as you like → page 316.

If you do not have access to engine oil that complies with the prescribed standard, in an emergency you may top up with a maximum of 0.5 l (0.5 qt) of the following oils once before the next regular oil change:

- Petrol engines: standards VW 504 00 and ACEA C3 or API SP, viscosity 0 W-30.
- Diesel engines: standards VW 507 00 and ACEA C3, viscosity 0 W-30.

#### ! NOTICE

Volkswagen recommends the use of approved engine oils in accordance with the respectively relevant VW standard. If engine oils that do not meet these quality requirements are used, it can cause engine damage.

 Volkswagen recommends having the oil change carried out by a suitably qualified workshop. Volkswagen recommends using a Volkswagen dealership.

 Volkswagen recommends Volkswagen genuine oil.

## Changing engine oil

 Please refer to  and  on page 310 and  at the start of the chapter on page 314.

The engine oil must be changed regularly and in accordance with the service interval → page 353.

Additives in the engine oil can cause new engine oil to discolour quickly. This is normal and does not mean that the engine oil should be changed more frequently.

### WARNING



Changing the engine oil incorrectly can cause environmental damage, fire and serious injuries.

- Always wear eye protection.
- Always allow the engine to cool down completely to avoid burns.
- Keep your arms horizontal when unscrewing the oil drain plug with your fingers to prevent the emerging oil from running down your arm.
- Use a suitable container when draining the used oil. It must be at least large enough to hold the entire filling quantity of engine oil.
- Never store engine oil in empty food containers, bottles or any other non-original containers as people finding these containers may not know that they contain engine oil.
- Engine oil is toxic and must be stored out of the reach of children.

### NOTICE

Oil and filter changes require special tools, expert knowledge and correct disposal of old oil.

- You should always have engine oil and filter changes performed by a suitably qualified workshop. Volkswagen recommends using a Volkswagen dealership.

 Dispose of the engine oil in an environmentally responsible manner and only at a collection point for used oil, e.g. a recycling centre or specialist company. 

## Engine oil consumption

 Please refer to  and  on page 310 and  at the start of the chapter on page 314.

-  Engine oil consumption can vary for different engines and can change during the service life of an engine.

Depending on driving style and operating conditions, engine oil consumption can be up to 1 l (1 qt) per 2,000 km (1,200 miles). In new vehicles, it is likely to be higher for the first 5,000 km (3,100 miles). The engine oil level must therefore be checked at regular intervals, preferably before long journeys.

When the engine is working hard, the engine oil level should be kept within the upper permissible area, for instance during extended motorway trips in summer or when climbing mountain passes → page 316. ◀

## Checking the engine oil level and refilling engine oil

📖 Please refer to ▲ and Ⓞ on page 310 and ▲ at the start of the chapter on page 314.

### Preparations

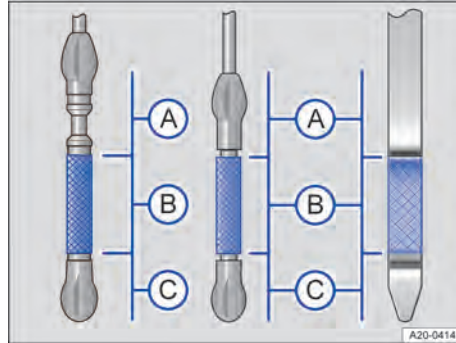

**Fig. 234** In the engine compartment: engine oil filler opening cap (illustration).

To avoid an incorrect reading of the engine oil level, observe the following steps:

1. Park the vehicle on a level surface with the engine at operating temperature.
2. Wait for at least 5 minutes for the engine oil to flow back into the sump.
3. Open the bonnet ▲ → page 312.
4. Identify the engine oil filler opening and oil dipstick. The engine oil filler opening can be recognised by the symbol on the cap 📖 → Fig. 234 and the oil dipstick has a coloured handle.

### Checking the engine oil level



**Fig. 235** Engine oil level markings on the oil dipstick (variants).

- Ⓐ Engine oil level is too high.
- Ⓑ Engine oil level in the normal range.
- Ⓒ Engine oil level too low.

The actions should only be carried out in the specified order:

1. Pull the oil dipstick out of the guide tube and wipe it off with a clean cloth.
2. Insert the oil dipstick into the guide tube again as far as it will go. If there is a marking on the oil dipstick, this marking must fit in the corresponding groove at the top end of the guide tube when inserting.
3. Pull out the oil dipstick again and read the engine oil level on the dipstick as follows → Fig. 235:



- Ⓐ Engine oil level too high – observe the messages on the instrument cluster display or contact a correspondingly qualified workshop, if necessary. Volkswagen recommends using a Volkswagen dealership.
  - Ⓑ Engine oil level in the normal range. The engine oil can be filled to the upper limit of this range, e.g. if the engine is operated at high loads → page 314, → page 315.
  - Ⓒ Engine oil level too low. It is essential to refill engine oil. If necessary, observe the messages in the instrument cluster display.
4. After reading off the engine oil level, push the oil dipstick back into the guide tube as far as it will go. If necessary, continue to refill with engine oil.







## Refilling engine oil

### WARNING

Engine oil can ignite if it comes into contact with hot engine components. This can cause fires, burns and other serious injuries.



- Always ensure that the engine oil filler opening cap is securely tightened after refilling, and that the dipstick is properly inserted back into the guide tube. This will prevent the engine oil from escaping onto hot engine components when the engine is running.
- If engine oil is spilt on cold engine components it can heat up and ignite when the engine is running.

The steps should only be carried out in the specified order →  → 

1. Unscrew the engine oil filler opening cap → Fig. 234.
2. Fill engine oil gradually in small quantities, not more than 0.5 l (0.5 qt) in total, or observe the recommendation on the instrument cluster.
3. In order to avoid overfilling, wait for at least 1 minute after each refill step to allow the engine oil to flow into the sump up to the marking on the engine oil dipstick.
4. Read the engine oil level on the engine oil level display on the Infotainment system screen again before refilling with a further small quantity of engine oil.  
**Or:** read the engine oil level from the dipstick again before refilling with a further small quantity of engine oil.  
Never overfill with engine oil.
5. After filling, the engine oil level should be in the middle of the area → Fig. 235 . It should not be above → Fig. 235 , i.e. in area , and must not be in the area above → Fig. 235 .
6. Do not start the engine if you have added an excessive amount of engine oil by accident and the engine oil level is thus above area → Fig. 235 . Notify a suitably qualified workshop. Volkswagen recommends using a Volkswagen dealership.
7. After refilling, close the engine oil filler opening with the cap → Fig. 234.
8. Close the bonnet  → page 312.

### Displaying service information on the Infotainment system

*Vehicles with an Infotainment system:*



1. Switch on the ignition.
2. Select and tap the  function button.
3. Tap the  function button.
4. Tap the  function button.

After a service event, the service message will be updated after around *five days* or after you have driven around 500 km (311 miles). Until then, the Infotainment system screen shows *Inspection in --- km / --- days Oil change: in --- km / --- days*.

### NOTICE

- If the engine oil level is in area → Fig. 235 , do not start the engine. Notify a suitably qualified workshop. Volkswagen recommends using a Volkswagen dealership.
- When refilling service fluids, ensure that you pour the correct service fluids into the correct openings. The use of incorrect service fluids could result in serious malfunctions and engine damage.

 Volkswagen recommends the use of approved engine oils in accordance with the respectively relevant VW standard.

 If you cannot find the cap and oil dipstick, please contact a correspondingly qualified workshop. Volkswagen recommends using a Volkswagen dealership. 

## Troubleshooting

 Please refer to  and  on page 310 and  at the start of the chapter on page 314.

### Engine oil pressure too low

The warning lamp flashes red. A message is shown on the instrument cluster display.

 Do not drive on! The engine could otherwise be damaged.

1. Stop the vehicle as soon as possible and when safe to do so.
2. Switch off the engine.
3. Check the engine oil level → page 316.
4. Do *not* drive on or leave the engine running if the warning lamp is flashing even when the engine oil level is correct. The engine could otherwise be damaged.
5. Seek expert assistance.

### Engine oil level very low

The warning lamp flashes red. A message is shown on the instrument cluster display.

 Do not drive on! The engine could otherwise be damaged.

1. Stop the vehicle as soon as possible and when safe to do so.
2. Switch off the engine.
3. Check the engine oil level → page 316.
4. If necessary, fill engine oil gradually in small quantities, not more than 0.5 l (0.5 qt) in total, or observe the filling recommendation on the instrument cluster.
5. Do *not* drive on or leave the engine running if the warning lamp is lit up even though the engine oil level is correct. The engine could otherwise be damaged.
6. Seek expert assistance.

### Engine oil level too low

The indicator lamp lights up yellow. A message is shown on the instrument cluster display.

1. Stop the vehicle as soon as possible and when safe to do so.
2. Switch off the engine.
3. Check the engine oil level → page 316.
4. If necessary, fill engine oil gradually in small quantities, not more than 0.5 l (0.5 qt) in total, or observe the filling recommendation on the instrument cluster.
5. Do *not* drive on or leave the engine running if the indicator lamp is lit up, even though the engine oil level is correct. The engine could otherwise be damaged.
6. Seek expert assistance.

### Engine oil level too high

The indicator lamp lights up yellow. A message is shown on the instrument cluster display.

1. Stop the vehicle as soon as possible and when safe to do so.
2. Switch off the engine.
3. Check the engine oil level → page 316.
4. If the engine oil level is too high, do *not* drive on or leave the engine running. The engine could otherwise be damaged.
5. Seek expert assistance.

### or Fault in engine oil system

The indicator lamp flashes yellow. A message is shown on the instrument cluster display.

1. Go to a correspondingly qualified workshop. Volkswagen recommends using a Volkswagen dealership. <

## Coolant

### Introduction to the topic

Do not work on the **cooling system** unless you are familiar with the task, aware of the general safety procedures and have the correct equipment, service fluids and suitable tools. Failing to carry out work correctly can cause serious injuries → . Have all work carried out by a correspondingly qualified workshop if necessary. Volkswagen recommends using a Volkswagen dealership.

### WARNING

Coolant is toxic.

- Keep coolant only in the sealed original container and in a safe place.
- Never store coolant in empty food containers, bottles or any other non-original containers as people finding these containers may then drink the coolant.
- Always store coolant out of the reach of children.
- The amount of correct coolant additive used must be sufficient for the lowest ambient temperature that you expect the vehicle to be exposed to.
- Coolant can freeze at extremely cold outside temperatures, causing the vehicle to break down. Vehicle occupants with inadequate winter clothing could then freeze to death as the heating will also no longer function.

 Coolant and coolant additives can pollute the environment. Spilt service fluids must be collected and disposed of properly and in an environmentally responsible way. <



## Coolant specification

📖 Please refer to ⚠️ and ⓘ on page 310 and ⚠️ at the start of the chapter on page 318.

The cooling system is filled at the factory with a mixture of specially treated water and at least 40% **G 12 evo** coolant additive (TL-VW 744 L).

The proportion of coolant additive must *always* be at least 40% to protect the cooling system. If greater frost protection is required in very cold climates, the proportion of anti-freeze additive can be increased. However, the percentage of coolant additive should not exceed 55 %, as this would reduce the frost protection and the cooling effect.

The coolant additive is dyed a violet colour. The mixture of water and a coolant additive offers anti-freeze protection down to -25°C (-13°F), protects the alloy parts in the cooling system against corrosion, prevents limescale deposits and significantly increases the boiling point of the coolant.

When refilling the coolant, a mixture of **distilled water** and at least 40% **G 12 evo** coolant additive must be used in order to obtain the optimum corrosion protection → ⓘ.

### ⚠️ WARNING

Insufficient anti-freeze in the cooling system can cause the engine to break down and cause serious injuries.

- The amount of correct coolant additive used must be sufficient for the lowest ambient temperature that you expect the vehicle to be exposed to.
- Coolant can freeze at extremely cold outside temperatures, causing the vehicle to break down. Vehicle occupants with inadequate winter clothing could then freeze to death as the heating will also no longer function.

### ⓘ NOTICE

Never mix genuine coolant additives with other coolants that have not been approved by Volkswagen.

- If the liquid in the coolant expansion tank is not violet (colouring results from mixing the purple coolant additive with distilled water) but for example brown instead of violet, the suitable coolant has been mixed with an unsuitable coolant additive. The coolant must be changed as soon as possible if this is the case. Failure to observe this warning can result in serious malfunctions or damage to the engine and cooling system.

🌿 Coolant and coolant additives can pollute the environment. Spilt service fluids must be collected and disposed of properly and with respect for the environment. <

## Checking the coolant level and re-filling coolant

📖 Please refer to ⚠️ and ⓘ on page 310 and ⚠️ at the start of the chapter on page 318.

### Preparations

1. Park the vehicle on a firm and level surface.
2. Allow the engine to cool down → ⚠️.
3. Open the bonnet ⚠️ → page 312.

The coolant expansion tank is identified by the red ⚠️ symbol on the cap → Fig. 236.



**Fig. 236** In the engine compartment: coolant expansion tank cap (illustration).

### ⚠️ WARNING

Hot steam and hot coolant can cause serious burns.

- Never open the bonnet if you can see or hear steam or coolant coming out of the engine compartment. Always wait until no escaping steam or coolant can be seen or heard. Hot components can burn the skin.
- The cooling system is under pressure when the engine is hot. Never open the cap of the coolant expansion tank when the engine is hot. Coolant may spray out and cause serious burns and other injuries.
  - Turn the cap slowly and very carefully anti-clockwise while exerting some downwards pressure on the cap.

— Always protect your face, hands and arms from hot coolant or steam by placing a large and thick cloth on the cap of the coolant expansion tank.

### Warning lamp



The warning lamp for the coolant will light up if the coolant level is too low.

1. **Do not drive on!** Stop the vehicle as soon as possible and when safe to do so.
2. Seek expert assistance immediately.

**Or:** if the engine coolant level is too low and you cannot seek professional assistance, check the coolant level and fill it up.

### Checking the coolant level

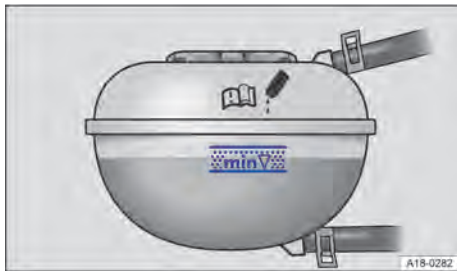

**Fig. 237** In the engine compartment: markings on the coolant expansion tank (illustration).

The engine coolant may be above the marked area upon delivery of “new vehicles”. This is normal. It is not necessary to remove coolant.

1. When the engine is cold, check the coolant level at the side markings of the coolant expansion tank → Fig. 237. The coolant level must be between the marks.
2. Have coolant added if the fluid level in the coolant expansion tank is below the minimum marking “min”. When the engine is warm, the engine coolant level may be slightly above the upper mark.
3. Do not add coolant if there is no longer any coolant visible in the coolant expansion tank → ⓘ.

### Adding coolant

1. Unscrew the lid carefully → ⚠.
2. Fill only with new coolant according to Volkswagen's specification → page 319.
3. Add coolant up to the upper level marking.

After adding the coolant, the coolant level must be between the markings on the coolant expansion tank → Fig. 237.

4. Close the cap tightly.
5. Check the coolant level after one day. If the level of the coolant tank drops below the minimum marking “min” again, please visit a correspondingly qualified workshop and have the cooling system checked. Volkswagen recommends using a Volkswagen dealership.
6. If in an emergency you do not have access to coolant with the required specification, do not use any other coolant additive → ⓘ.

### ! NOTICE

- Do not fill coolant above the top edge of the marked area. Otherwise the excess coolant will be pressed out of the cooling system when the engine is hot and could cause damage.
- If in an emergency you do not have access to coolant in the required specification, add only distilled water initially. Then have the correct mixture ratio with the coolant additive restored by a suitably qualified workshop as soon as possible. Volkswagen recommends using a Volkswagen dealership.
- Refill only with distilled water! All other types of water can cause corrosion in the engine due to the chemical components contained in the water. This can also lead to engine failure. If any type of water other than distilled water is used, the fluid in the cooling system should be completely replaced immediately by a suitably qualified workshop. Volkswagen recommends using a Volkswagen dealership.
- Do not top up with coolant if there is no more coolant in the coolant expansion tank. Air could have entered the cooling system. Do not drive on. Seek qualified professional assistance. Failure to do so can result in engine damage.
- When refilling service fluids, ensure that you pour the correct service fluids into the correct openings. The use of incorrect service fluids could result in serious malfunctions and engine damage. <

## Brake fluid



**Fig. 238** In the engine compartment: cap of the brake fluid reservoir.

Brake fluid will gradually absorb water from the surrounding air over the course of time. The brake system will be damaged if there is too much water in the brake fluid. The boiling point of the brake fluid is also considerably reduced by the water content. Heavy use of the brakes may cause a vapour lock in the brake system if the water content is too high. Vapour locks reduce the braking efficiency, considerably increase braking distance and can even cause the brake system to fail completely. Your own safety and that of other road users depends on having a brake system that functions properly at all times → ⚠.

### Brake fluid specification

Volkswagen has developed a brake fluid that has been optimised for the brake system in the vehicle. To ensure the best possible operation of the brake system, Volkswagen expressly recommends the use of brake fluid compliant with "VW standard 501 14".

Before using a particular brake fluid, check that the specifications printed on the container correspond to the vehicle requirements.

Brake fluid that is compliant with VW standard 501 14 is available from Volkswagen dealerships.

If this brake fluid is not available and it is necessary to use another high-quality brake fluid instead, brake fluid that is compliant with DIN ISO 4925 or US standard FMVSS 116 DOT 4 CLASS 6 can be used.

Not all brake fluids that are compliant with DIN ISO 4925 or US standard FMVSS 116 DOT 4 CLASS 6 have the same chemical composition. Some of these brake fluids may contain chemicals that can damage or destroy brake system components over time.

Volkswagen therefore recommends the use of brake fluid that is compliant with "VW standard 501 14" to ensure sustained optimal operation of the brake system.

Brake fluid that is compliant with VW standard 501 14 fulfils the requirements of DIN ISO 4925 or US standard FMVSS 116 DOT 4 CLASS 6.

### Brake fluid level

The brake fluid level must always be between the MIN and MAX markings on the brake fluid reservoir → ⚠.

The brake fluid level cannot be checked accurately in all models as a flap or engine components may partially conceal the brake fluid container. If the brake fluid level cannot be read exactly, please seek assistance from a suitably qualified workshop. Volkswagen recommends using a Volkswagen dealership.

The brake fluid level drops slightly during vehicle operation as the brake pads wear and the brakes are automatically adjusted.

### ⚠ Brake fluid level

The warning lamp lights up red.

Brake fluid level is too low.

1. 🚫 Do not drive on!
2. Check the brake fluid level.
3. Seek expert assistance if the brake fluid level is too low.

### Changing the brake fluid

The brake fluid should be changed regularly. Qualified workshops can provide information on the intervals for changing the vehicle's brake fluid. Only brake fluid that conforms with the required specification should be used. Volkswagen recommends using a Volkswagen dealership.

### ⚠ WARNING

Brake failure or reduced braking efficiency can be caused by the brake fluid level being too low or by brake fluid that is too old or unsuitable. Heavy use of the brakes with old brake fluid can cause a vapour lock due to the absorbed moisture. Vapour locks reduce braking efficiency, considerably increase braking distance and can cause the brake system to fail completely.

- Have the brake system and brake fluid level checked regularly or have the brake fluid changed.
- Have the brake system filled only with new brake fluid.

- Make sure that the correct brake fluid is used. Use only brake fluid that is explicitly compliant with VW standard 501 14. Any other brake fluid or a low-quality fluid can affect the functioning of the brakes and reduce braking efficiency.
- If a brake fluid compliant with VW standard 501 14 is not available, use a high-quality brake fluid compliant with DIN ISO 4925 or the US standard FMVSS 116 DOT 4 CLASS 6, but only in exceptional circumstances.

### WARNING

Brake fluid is toxic.

- In order to reduce the risk of poisoning, never use bottles or other containers to store brake fluid. There is always a risk of someone drinking from such containers, even if they are labelled appropriately.
- Always store brake fluid in its original sealed container and out of the reach of children.

### NOTICE

Brake fluid that has leaked or been spilt can damage the vehicle paintwork, plastic parts and tyres.

- Wipe off brake fluid that has leaked or been spilled immediately from all parts of the vehicle.

 Brake fluid can pollute the environment. Any spilt service fluids must be cleaned up and disposed of properly.

## 12-volt vehicle battery

### Introduction to the topic

The 12-volt vehicle battery is a component of the electrical system and serves to supply power in the vehicle. In the scope of maintenance work, the 12-volt vehicle battery is checked and where required, replaced.

You should only carry out work on the electrical system if you know exactly how to perform the required tasks, are aware of the general safety procedures and have access to the correct equipment, service fluids and suitable tools. Failing to carry out work correctly can cause serious injuries → . All work should be carried out by a correspondingly qualified workshop. Volkswagen recommends using a Volkswagen dealership.

Information on warning and indicator lamps that light up can be found in the troubleshooting sections at the end of the chapter → page 326.

### Battery switch-off in an accident in which the air-bag is triggered

The electrical connection to the 12-volt vehicle battery is automatically disconnected pyrotechnically in vehicles with a 12-volt vehicle battery in the vehicle interior or luggage compartment in the event of an accident in which the airbags are triggered. This prevents a short circuit. You can find information on the location of the vehicle battery in the section Checking the electrolyte level of the 12-volt vehicle battery → page 323.

### Explanation of the warnings on the 12-volt vehicle battery



Always wear eye protection!



Electrolyte is very corrosive and caustic. Always wear protective gloves and eye protection!



No fire, sparks, naked lights or smoking!



A highly explosive mixture of gases is given off when the 12-volt vehicle battery is charging!



Always keep children away from electrolyte and the 12-volt vehicle battery!



Always observe the owner's manual!

### WARNING

Any work on the 12-volt vehicle battery and the electrical system can cause serious chemical burns, fire or electric shocks. Always read the following warnings and safety information before carrying out any kind of work:

- Switch off the ignition and all electrical consumers before carrying out any work on the 12-volt vehicle battery and also disconnect the negative cable from the 12-volt vehicle battery.
- Children should always be kept away from electrolyte and the 12-volt vehicle battery.
- Always wear eye protection and protective gloves.
- Electrolyte is very aggressive. It can burn the skin and can cause blindness. When working with the 12-volt vehicle battery, ensure that your hands, arms and face in particular are protected from acid spillage.
- Never smoke and work near naked flames or sparks.

- When handling cables and electrical equipment, avoid generating sparks and electrostatic discharge.
- Never short circuit battery terminals.
- Never use a damaged 12-volt vehicle battery. The 12-volt vehicle battery can explode. Replace a damaged 12-volt vehicle battery immediately.
- Never use a frozen 12-volt vehicle battery. Discharged 12-volt vehicle batteries can already freeze at temperatures of around 0°C (+32°F). Replace the 12-volt vehicle battery immediately.

### NOTICE

Ultraviolet radiation can damage the battery housing.

- Do not expose the 12-volt vehicle battery to direct sunlight for an extended period.

### NOTICE

The 12-volt battery can freeze and be destroyed as a result.

- Protect the 12-volt vehicle battery against frost if the vehicle is left standing for extended periods.

 When you start the engine after the 12-volt battery has been totally discharged or after jump starting, you may find that system settings (time, date, personal convenience settings and programming) have been changed or deleted. Check and correct the settings once the 12-volt vehicle battery has recharged sufficiently.

## Checking the electrolyte level of the 12-volt vehicle battery

 Please refer to  and  on page 310 and  and  at the start of the chapter on page 322.

The electrolyte level of the 12-volt vehicle battery should be checked regularly in high-mileage vehicles, in hot countries and in older 12-volt vehicle batteries. The 12-volt vehicle battery is otherwise maintenance-free.

### Location of 12-volt vehicle battery

The 12-volt vehicle battery is located in the engine compartment.

### Preparations

1. Preparing the vehicle for working in the engine compartment → page 310.

2. Open the bonnet  → page 312.

## Checking the electrolyte level on vehicles with 12-volt vehicle battery in the engine compartment

### WARNING

Any work on the 12-volt vehicle battery can cause serious chemical burns, explosions and electric shocks.

- Always wear eye protection and protective gloves.
- Never use naked flames or glowing objects as a light source.
- Electrolyte is very aggressive. It can burn the skin and can cause blindness. When working with the 12-volt vehicle battery, ensure that your hands, arms and face in particular are protected from acid spillage.
- Never open a 12-volt vehicle battery.
- Never tilt the 12-volt vehicle battery. Electrolyte may spill out of the battery vents and cause chemical burns.
- If acid is splashed onto your skin or into your eyes, rinse immediately for several minutes with cold water. Then consult a doctor immediately.
- If electrolyte is swallowed, consult a doctor immediately.

Depending on equipment, it may be necessary to remove an additional bracket in order to view the battery window. An additional tool that is not included in the vehicle toolkit is required for this purpose.



**Fig. 239** Battery window on the top of the 12-volt vehicle battery (illustration).

Ensure that enough light is available for you to clearly see the colour indicator in the round window on the top of the 12-volt vehicle battery → [Fig. 239](#).

The colour displayed in the round battery window changes according to the electrolyte level in the 12-volt vehicle battery.

**Light yellow or without colour** The electrolyte level of the 12-volt vehicle battery is too low. Have the 12-volt vehicle battery replaced by a correspondingly qualified workshop. Volkswagen recommends using a Volkswagen dealership.

**Black** The electrolyte level of the 12-volt vehicle battery is correct.

The electrolyte level of 12-volt vehicle batteries that are marked as **AGM** cannot be checked for technical reasons. The battery can be checked by a correspondingly qualified workshop. Volkswagen recommends using a Volkswagen dealership.

## Charging, replacing, disconnecting and connecting the 12-volt vehicle battery

📖 Please refer to ⚠️ and ⌚ on page 310 and ⚠️ and ⌚ at the start of the chapter on page 322.

If you suspect that the 12-volt vehicle battery is damaged or faulty, go to a correspondingly qualified workshop and have the 12-volt vehicle battery checked. Volkswagen recommends using a Volkswagen dealership.

### Charging the 12-volt vehicle battery

The 12-volt vehicle battery should be charged by a correspondingly qualified workshop, as the technology used in factory-fitted 12-volt vehicle batteries requires voltage-limited charging → ⚠️. Volkswagen recommends using a Volkswagen dealership.

### Replacing the 12-volt vehicle battery

The 12-volt vehicle battery has been developed to suit the conditions of its installation location and has special safety features. If a 12-volt vehicle battery has to be replaced, the replacement part must be installed by a workshop qualified to do this. Volkswagen recommends using a Volkswagen dealership. For component information on size and the required maintenance, capacity and safety features, please contact a correspondingly qualified workshop, which must have the necessary technical documentation and equipment. Volkswagen recommends using a Volkswagen dealership. The ventilation opening of the 12-volt vehicle battery must always be on the negative terminal side: the ventilation opening on the positive terminal side must always be sealed → ⚠️.

Only maintenance-free 12-volt vehicle batteries compliant with the standards TL 825 06 and VW 7 50 73 should be used. These standards must be dated October 2014 or later.

The 12-volt vehicle battery must always be replaced by a workshop qualified to do this, as the vehicle electronics must be adapted as part of the replacement process. Only workshops qualified to do this have the technology required to carry out this adjustment and also the correct replacement batteries.

### Disconnecting the 12-volt vehicle battery

Please observe the following if the 12-volt vehicle battery has to be disconnected from the electrical system in the vehicle:

1. Switch all electrical consumers off.
2. Unlock the vehicle before disconnecting the battery in order to avoid triggering the anti-theft alarm.
3. First disconnect the negative cable and then the positive cable → ⚠️.

### Connecting the 12-volt vehicle battery

Please observe the following if the 12-volt vehicle battery has to be connected to the electrical system in the vehicle:

1. Switch all electrical consumers off.
2. First reconnect the positive cable and then the negative cable → ⚠️.

Various indicator lamps may light up after the 12-volt vehicle battery has been connected and the ignition is switched on. They will go out if you drive a short distance at a speed of approximately 15 km/h to 20 km/h (10 mph to 12 mph). If the indicator lamps stay lit, the vehicle should be checked by a suitably qualified workshop. Volkswagen recommends using a Volkswagen dealership.

If the 12-volt vehicle battery was disconnected for an extended period, the system may not be able to calculate or correctly display the time when the next service is due → page 33. Observe the maximum permissible service intervals → page 353.

**Vehicles with starter button:** Perform the following actions if the ignition cannot be switched on after connecting the 12-volt vehicle battery:

1. Lock and unlock the vehicle from the outside.
2. Try to switch on the ignition again → page 139.

Please seek expert assistance if the ignition cannot be switched on.

### Automatic switch-off for electrical consumers

If the ignition is switched on for an extended period when the engine is switched off or the side or park-

ing lights are switched on for a long time when the vehicle is parked, the intelligent onboard supply management system cannot always prevent discharge of the 12-volt vehicle battery.

If the 12-volt vehicle battery is subject to high loads, the intelligent onboard supply management system automatically performs various measures to prevent discharge of the 12-volt vehicle battery.

- The idling speed is increased so that the alternator provides more electricity.
- The performance of large electrical consumers may be reduced or they may be switched off completely.
- The power supply to the 12-volt socket may be interrupted briefly while the engine is being started.

#### 12-volt vehicle battery is discharged

- By long standing periods without running the engine, especially if the ignition is switched on.
- Through use of electrical consumers when the ignition is switched off.
- By operating the auxiliary heater → page 126.

#### WARNING

Incorrectly securing the battery and using incorrect 12-volt vehicle batteries can cause short circuits, fire and serious injuries.

- Always use maintenance-free and leak-proof 12-volt vehicle batteries that have the same properties, specifications and dimensions as the factory-fitted 12-volt vehicle battery.

#### WARNING

A highly explosive mixture of gases is given off when the 12-volt vehicle battery is being charged.

- 12-volt vehicle batteries should only be charged in well-ventilated spaces.
- Never charge a 12-volt vehicle battery which is frozen or has been frozen. Discharged 12-volt vehicle batteries can already freeze at temperatures of around 0°C (+32°F).
- The 12-volt vehicle battery must be replaced if it has ever frozen.

#### WARNING

A highly explosive mixture of gases is produced in the 12-volt vehicle battery during vehicle operation.

- In vehicles with the 12-volt vehicle battery in the vehicle interior or luggage compartment, make sure that the vent line is connected properly to the 12-volt vehicle battery. The vent line

must always be attached on the negative terminal side of the 12-volt vehicle battery. If there is an opening on the positive terminal side of the 12-volt vehicle battery, this must always be closed.

#### WARNING

Incorrectly connected cables can cause a short circuit.

- First connect the positive cable and then the negative cable.

#### NOTICE

Never connect or disconnect 12-volt vehicle batteries if the ignition is switched on or the engine is running.

- This can damage the electrical system or electronic components, which can cause electrical faults.

#### NOTICE

Never connect equipment that supplies electric power, such as solar panels or a battery charger, to the 12-volt socket to charge the 12-volt vehicle battery.

- This can damage the electrical system or electronic components, which can cause electrical faults.

#### NOTICE

Never use a 12-volt vehicle battery that does not correspond with the vehicle's specifications.

- This can damage the electrical system or electronic components, which can cause electrical faults.

 12-volt vehicle batteries may contain toxic substances such as sulphuric acid and lead. Dispose of the 12-volt vehicle battery in accordance with the relevant regulations.

 Electrolyte can pollute the environment. Clean up any service fluid leakages and dispose of them properly. <

## Troubleshooting

📖 Please refer to  and  on page 310 and  and  at the start of the chapter on page 322.

### 12-volt power supply

The warning lamp lights up red. A message is shown on the instrument cluster display.

 Do not drive on! Possible failure of the electrical system.

1. Stop the vehicle immediately in a safe place → page 190.
2. Switch off any electrical consumers that are not required.
3. Switch off the ignition.
4. Seek expert assistance.

When the red warning lamp is lit up, the start/stop system is switched off. The start/stop system will be switched on again automatically when the engine is restarted. → page 144.

### 12-volt power supply

The indicator lamp lights up yellow. A message is shown on the instrument cluster display.

Messages about the charge level of the 12-volt vehicle battery.

1. Allow the engine to run so that the 12-volt vehicle battery can be recharged.

If the message about the charge level of the 12-volt vehicle battery does not disappear after a few minutes in spite of the measures performed, seek expert assistance.

Messages about the 12-volt power supply.

1. Seek expert assistance.

When the yellow indicator lamp is lit up, the start/stop system cannot start the engine. When the yellow indicator lamp has gone out, the charge level of the 12-volt vehicle battery is sufficient for an automatic engine restart → page 144.

## Wheels and tyres

### Tyre monitoring systems

#### Introduction to the topic

The tyre monitoring system warns the driver when the tyre pressures are too low.

The following tyre monitoring systems are available for this vehicle:

#### Tyre Pressure Loss Indicator

– Monitors various parameters, including rolling circumference, of all four tyres while driving using ABS sensors (indirect measurement).

#### Tyre Pressure Monitoring System

– Monitors the tyre pressure by means of pressure sensors on each tyre valve (direct measurement). Tyre valves made of metal.

The reference pressure for the tyre monitoring system is the recommended tyre pressure for cold factory-fitted tyres at maximum load. The reference pressure corresponds to the information on the tyre pressure sticker → page 334.

If the tyre pressure of all four tyres has been adjusted correctly, the Tyre Pressure Loss Indicator must be re-synchronised → page 328. This adjusts the reference pressure to the current tyre pressure. The Tyre Pressure Loss Indicator (ⓘ) may react with a delay or not display anything at all in the event of a sporty driving style, when driving on snow-covered or icy roads or unpaved roads or when driving with snow chains.

The recommended tyre pressure for the factory-fitted tyres is indicated on the tyre pressure sticker on the driver's door pillar → page 334.

The tyre pressure of all tyres including the spare wheel or temporary spare wheel must be checked monthly on a cold tyre and correspond to the vehicle manufacturer's specifications on the tyre pressure sticker. If the tyre size of the mounted tyres differs from the specifications on the type plate or tyre pressure sticker, the correct tyre pressure must be determined.

As an additional safety feature, the vehicle is equipped with a Tyre Pressure Monitoring System (TPMS) where an indicator lamp for low tyre pressure lights up if the pressure in one or more of the tyres is much too low. If the indicator lamp for low tyre pressure lights up, you should therefore stop the ve-



hicle as quickly as possible, check the tyres, and inflate them to the correct pressure. Driving with a tyre pressure that is much too low will lead to the tyre overheating and can damage the tyre. A tyre pressure that is too low also reduces the fuel efficiency and service life of the tyre tread and can negatively affect the driving behaviour and braking capability of the vehicle.

The Tyre Pressure Loss Indicator does not remove the need for regular maintenance and inspection of tyres. The driver is responsible for ensuring the correct tyre pressure is maintained at all times, even if the Tyre Pressure Loss Indicator does not give any warning that the tyre pressure is too low.

The tyre monitoring system additionally has a fault indicator that issues a warning if the system is not functioning properly. This fault indicator is coupled with the indicator lamp for low tyre pressure. If the system detects a fault, the warning lamp flashes for around 1 minute when the vehicle is started and then lights up continuously. This sequence is then repeated each time the vehicle is started as long as the fault is present.

If the Tyre Pressure Loss Indicator shows a malfunction, tyre pressure cannot be monitored correctly. A malfunction of the Tyre Pressure Loss Indicator can have various causes, e.g. due to replacement of a wheel or tyre. After replacing a wheel or tyre, it is necessary to check whether the  warning lamp indicates a system fault in order to ensure that the Tyre Pressure Loss Indicator is functioning correctly → page 330, → page 330.

### WARNING

The intelligent tyre monitoring system technology cannot overcome the laws of physics, and functions only within the limits of the system. Incorrect handling of the wheels and tyres can lead to a sudden loss of pressure in the tyres, tread separation and even tyre blow-out.

- Check the tyre pressure regularly and always maintain the specified pressure → page 334. If the tyre pressure is too low, it is possible that the tyre temperature will increase to such an extent that the tread peels off and the tyre bursts.
- Always maintain the correct cold tyre pressure as specified on the tyre pressure sticker → page 334.
- Check the tyre pressure regularly when the tyres are cold. If necessary, adjust the tyre pressure in the cold tyre to the recommended tyre pressure for the tyres installed on your vehicle → page 334.

- Check your tyres regularly for signs of wear or damage.
- Never exceed the top speed and load permitted for the fitted tyres.

### WARNING

Differing tyre pressures or tyre pressures that are too low can cause tyre damage, tyre failure, loss of vehicle control, accidents, serious injury and death.

- If the  indicator lamp lights up, stop immediately and check all tyres → page 334.
- Different tyre pressures or tyre pressures that are too low can increase wear on the tyres, reduce vehicle stability and increase the braking distance.
- The driver is responsible for the correct tyre pressure of all tyres on the vehicle. The recommended tyre pressure can be found on a sticker → page 334.
- The tyre monitoring system cannot function correctly unless all cold tyres have the correct tyre pressure.
- The pressure in all tyres must always be appropriate to the vehicle load → page 334.
- Always inflate all tyres to the correct tyre pressure before every journey → page 334.
- If the vehicle is driven with insufficient tyre pressure, this results in greater tyre flexing. This could warm up the tyre to such an extent that the tread may separate and the tyre could burst. This could cause the driver to lose control of the vehicle.
- High speeds and overloading of the vehicle may cause the tyres to heat up to such an extent that the tyre bursts, leading you to lose control of the vehicle.
- If the tyre pressure is too low or too high, the tyres will wear prematurely and the vehicle will not handle well.
- If the tyre is not flat and it is not necessary to change the wheel immediately, drive at low speed to the nearest correspondingly qualified workshop and have the tyre pressure checked and corrected → page 334. Volkswagen recommends using a Volkswagen dealership.
- The Tyre Pressure Loss Indicator must always be correctly calibrated.



If the tyre pressure is too low, this will increase fuel consumption and tyre wear.





When new tyres are driven at high speeds for the first time, they can expand slightly and trigger a one-off pressure warning.

 Old tyres should be replaced only by tyres that have been approved by Volkswagen for the vehicle type.

 Do not rely only on the tyre monitoring system. Check your tyres regularly to ensure that they are properly inflated and have no signs of damage, such as punctures, cuts, cracks, and blisters. Remove any objects that become embedded in the tyre tread but have not penetrated into the body of the tyre itself.

## Tyre Pressure Loss Indicator

 Please refer to  at the start of the chapter on page 326.

### Functional description

The Tyre Pressure Loss Indicator uses data from the ABS sensors and other functions to check the speed of rotation and the rolling circumference of the individual wheels.

 The Tyre Pressure Loss Indicator does not work if there is a fault in the ESC or ABS → page 209.

### The rolling circumference can change:

- If the tyre pressure has been changed.
- If the tyre pressure is too low.
- If the tyre has structural damage.
- If the vehicle is loaded more heavily on one side.
- If snow chains have been fitted.
- If a temporary spare wheel has been fitted.
- If one wheel per axle has been changed.

The Tyre Pressure Loss Indicator (ⓘ) may react with a delay or not display anything at all in the event of a sporty driving style, when driving on snow-covered or icy roads or unpaved roads or when driving with snow chains.

The Tyre Pressure Loss Indicator shows a change in rolling circumference of the tyres with the ⓘ warning lamp in the instrument cluster.

The recommended tyre pressure for the factory-fitted tyres is indicated on the tyre pressure sticker on the driver's door pillar → page 334.

The tyre pressure of all tyres must be checked monthly on the cold tyres and correspond to the vehicle manufacturer's specifications on the tyre pressure sticker.

This also applies to the tyre pressure of the spare wheel or temporary spare wheel.

If the tyre size of the mounted tyres differs from the specifications on the type plate or tyre pressure sticker, the correct tyre pressure must be determined.

The Tyre Pressure Loss Indicator does not remove the need for regular maintenance and inspection of tyres. The driver is responsible for ensuring the correct tyre pressure is maintained at all times, even if the Tyre Pressure Loss Indicator does not give any warning that the tyre pressure is too low.

The Tyre Pressure Loss Indicator can also display a malfunction in conjunction with the ⓘ warning lamp. If the Tyre Pressure Loss Indicator is malfunctioning, the ⓘ warning lamp lights up for about 1 minute after the ignition was switched on and then stays continuously lit.

If the Tyre Pressure Loss Indicator shows a malfunction, tyre pressure cannot be monitored correctly. A malfunction of the Tyre Pressure Loss Indicator can have various causes, e.g. due to replacement of a wheel or tyre. When a wheel or tyre has been replaced, check whether the ⓘ warning lamp is indicating a system malfunction to ensure that the Tyre Pressure Loss Indicator is functioning properly → page 330.

### Synchronising the Tyre Pressure Loss Indicator

The Tyre Pressure Loss Indicator must be resynchronised under the following conditions:

- If the tyre pressures have been changed.
- If one or more wheels have been changed.
- If the wheels are swapped over, e.g. from front to rear.

The Tyre Pressure Loss Indicator may only be resynchronised if all the tyres have been filled at the correct tyre pressure when measured on a cold tyre. To measure the cold tyre pressure, the vehicle must have been stationary for 3 hours or driven only a few kilometres at a slow speed during this time.

 After a warning about the tyre pressure being too low, switch the ignition off and then back on again. This is necessary before you can adapt the Tyre Pressure Loss Indicator again.

1. Switch on the ignition.
2. Depending on the version, press the **(MENU)** → page 37 button or function button and open the Vehicle menu in the Infotainment system.  
**Or:** press the **(CAR)** button or function button, depending on the version.
3. Depending on version, tap the **(Settings)** function button.
4. Tap the **(Tyres)** function button.

- Tap the **SET** function button.
- When all four tyre pressures correspond to the required values, tap the **Confirm** function button.

After an extended driving time of at least 20 minutes and driving at different speeds, the system will automatically learn the new values and monitor them.

**Or:** to cancel the operation, tap the **Cancel** function button.

The current tyre pressure is not saved and the system will not be re-synchronised.

The vehicle is displayed with the target and actual pressures of all the wheels → Fig. 240.

When the ignition is switched on, the last measured tyre pressures will be displayed first; these values will be updated when the journey is started. If the tyre pressure is too low, the respective actual values and the affected tyres will be highlighted → Fig. 240.

If the tyres are in rest state, the sensors will not transmit any tyre pressures. This stops the sensor batteries discharging.

If no tyre pressures are transmitted, the last received tyre pressures are shown in grey.

### Switching the Tyre Pressure Monitoring System on and off (vehicle-dependent)

Observe any country-specific legal requirements for the Tyre Pressure Monitoring System.

If a set of tyres is fitted to the vehicle where the tyres either do not have wheel sensors or have wheel sensors that are not compatible with the vehicle, the indicator lamp (L) will flash for approximately 1 minute and will then remain lit continuously. The tyre pressures will not be monitored. The system cannot be switched off.

### Adjusting the tyre pressure

Following any change in the vehicle load, the tyre pressure must be checked and adjusted as necessary. The tyre pressures recommended for the vehicle are on a sticker on the driver door pillar or on the inside of the tank flap.

There may be differences between the readings on the pressure gauge when filling the tyres and the values determined by the TPM. The TPM is more precise.

### Selecting target pressures for partial or full vehicle load

The driver must select the appropriate target pressure depending on the vehicle load level.

- Switch on the ignition.
- Press the **MENU** button or function button, depending on version.
- Tap the **(Vehicle)** function button.
- Tap the **(Settings)** function button.
- Select the **Tyres** menu option.
- Select the **Load** menu option.
- Select the load level.

### Selecting the tyre type

If the tyre size is changed, it may be necessary to adjust the target pressure for the new tyres. If no

## Tyre Pressure Monitoring System

Please refer to **▲** at the start of the chapter on page 326.

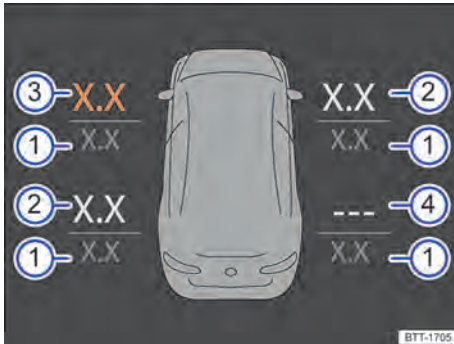

Fig. 240 Illustration of display in the instrument cluster: current tyre pressures.

- Target pressure in bar.
- Actual pressure in bar.
- Loss in pressure at front left.
- System fault at rear right.

### Functional description

The Tyre Pressure Monitoring System (TPM) monitors the tyre pressure of the four wheels while the vehicle is in motion using pressure sensors on the tyres. The system warns the driver in the event of a pressure loss.

### Display of tyre pressures on the instrument cluster display

- Open the menu **Vehicle status** in the instrument cluster display → page 37.

adjustment is necessary, the selection menu will not be available.

1. Switch on the ignition.
2. Press the **MENU** button or function button, depending on version.
3. Tap the **Vehicle** function button.
4. Tap the **Settings** function button.
5. Select the **Tyres** menu option.
6. Select the appropriate tyre size.

If the tyre sizes are fitted that do not correspond to the factory-specified sizes, the corresponding target tyre pressures can be entered by a correspondingly qualified workshop. Volkswagen recommends using a Volkswagen dealership.



### Spare wheel, temporary spare wheel or collapsible spare wheel

The tyre pressure of the spare wheel, temporary spare wheel or collapsible spare wheel in the luggage compartment is not monitored.

#### NOTICE

- The pressure sensors are secured to special aluminium valves that are screwed rigidly in place. When inflating the tyres and checking the pressure, do not bend the valves into position.
- Missing valve caps could lead to damage to the valve and the sensors. Therefore always make sure that all valve caps are fully screwed on while driving. Do not use metal valve caps.
- Do not use "convenience" valve caps as they do not form a proper seal. This can cause damage to the sensors.

## Troubleshooting for Tyre Pressure Loss Indicator

 Please refer to  at the start of the chapter on page 326.

### Low tyre pressure

The indicator lamp lights up yellow.

There is a loss of pressure in one or more tyres or the tyre is structurally damaged.

1.  **Do not drive on!**
2. Check and adjust all tyre pressures → page 334.
3. Damaged tyres should be replaced.



4. Re-synchronise the Tyre Pressure Loss Indicator → page 328.
5. If the fault persists, go to a correspondingly qualified workshop. Volkswagen recommends using a Volkswagen dealership.

### Fault in the Tyre Pressure Loss Indicator



The indicator lamp flashes for about 1 minute and then remains lit continuously yellow.

There is a system fault.

1.  **Do not drive on!**
2. Switch the ignition off and then back on again.
3. Re-synchronise the Tyre Pressure Loss Indicator → page 328.
4. If the fault persists, go to a correspondingly qualified workshop. Volkswagen recommends using a Volkswagen dealership.

 Driving on unpaved roads for long periods or a sporty driving style can temporarily deactivate the Tyre Pressure Loss Indicator. In the event of a malfunction, the indicator lamp will flash for about 1 minute and then light up continuously. However, the indicator lamp will go out when the road conditions or driving style change. 

## Troubleshooting for Tyre Pressure Monitoring System

 Please refer to  at the start of the chapter on page 326.

### Low tyre pressure

The indicator lamp lights up yellow.

Text message: Flat tyre! The tyre pressure of one or more tyres is below 1.4 bar (20 psi/140 kPa) or there is a critical loss of tyre pressure.

1.  **Do not drive on!**
2. Check all wheels for exterior damage or foreign bodies that have entered the tyres.
3. Check the tyre pressure for all tyres → page 334.
4. Change the wheel or drive at a low speed to the nearest correspondingly qualified workshop. Volkswagen recommends using a Volkswagen dealership.

Text message: Tyre pressures too low! The warning indicates at least one tyre with a critical tyre pressure.

1. Check and adjust the tyre pressure for all tyres → page 334.

2. Change the wheel or drive at a low speed to the nearest correspondingly qualified workshop. Volkswagen recommends using a Volkswagen dealership.

Text message: Please check tyre pressures. The warning indicates at least one tyre with a reduced tyre pressure.

1. Avoid long journeys and high speeds as long as the warning is displayed.
2. Check → page 334 and adjust the tyre pressure for all tyres.

### Fault in the Tyre Pressure Monitoring System

The indicator lamp flashes for about 1 minute and then remains lit continuously yellow.

One or more wheels with a tyre pressure sensor have been fitted but have not yet been detected by the system.

1. Drive for a few minutes until the indicator lamp goes out.

One or more wheels without a tyre pressure sensor have been fitted or a tyre pressure sensor is faulty.

1. Fit wheels with functional tyre pressure sensors.

There is a system fault.

1. Switch the ignition off and then back on again. If the fault persists, go to a correspondingly qualified workshop. Volkswagen recommends using a Volkswagen dealership.

There is a transmission fault between the sensor and the system. The function of the system may be temporarily impaired if there is interference from signals in the same frequency range as these transmitters.

1. Switch off or avoid any interference sources, e.g. two-way radios, remote controls or children's toys.

## Useful information about wheels and tyres

### Introduction to the topic

The tyres are the most heavily loaded and most underestimated parts of a vehicle. Tyres are very important as the narrow tyre surfaces are the only contact between the vehicle and the road.

The service life of tyres is dependent on tyre pressure, driving style, handling and correct fitting.

### WARNING

New tyres or tyres which are old, worn down or damaged cannot provide full levels of vehicle control and braking efficiency.

- Incorrect handling of wheels and tyres can reduce vehicle safety and cause accidents and serious injuries.
- All four wheels must be fitted with radial tyres of the same type, size (rolling circumference) and the same tread pattern.
- You must run in new tyres as they will initially have reduced grip and braking efficiency. Drive particularly carefully for the first 600 km (370 miles) in order to prevent accidents and serious injury.
- Check the tyre pressure regularly when the tyres are cold and always maintain the specified pressure. If the tyre pressure is too low, it is possible that the tyre temperature will increase to such an extent when driving that the tread peels off and the tyre bursts.
- Check the tyres regularly for damage and wear.
- Never drive with worn tyres or tyres that shows signs of damage such as holes, cuts, cracks or blisters. Driving with tyres in this condition can result in burst tyres, accidents and serious injuries. Replace worn or damaged tyres immediately.
- Never exceed the top speed and load permitted for the fitted tyres.
- The effectiveness of the driver assist systems and brake support systems depends on the tyre grip.
- If you notice unusual vibration, or if the vehicle pulls to one side when driving, stop immediately and check the wheels and tyres for damage.
- In order to reduce the risk of losing control of the vehicle, and the risk of accident and serious injury, never loosen the bolts on rims with bolted-on rim rings.
- Do not use wheels or tyres if you do not know their history. Used wheels and tyres may be damaged, even if the damage is not visible. This can cause tyre damage, tyre failure and loss of control of the vehicle.
- Even if they have not been used, old tyres can suddenly lose pressure or burst, especially at high speeds, and thus cause accidents and serious injuries. Use tyres that are more than six years old only if you have no alternative. In this case, drive slowly and with extra care at all times.

## ⚠ WARNING

If the wheels are incorrectly fastened or if wheel bolts are missing, the wheels could come loose, leading to a loss of control of the vehicle, causing accidents and serious injuries.

- Never drive if wheel bolts are missing or loose.
- Always use wheel bolts that match the wheel rims and the vehicle type.
- Always tighten the wheel bolts with the correct tightening torque. If you do not have a torque wrench, tighten the wheel bolts with the wheel bolt wrench and have the torque checked without delay by the nearest correspondingly qualified workshop. Volkswagen recommends using a Volkswagen dealership.

## ⚠ WARNING

If the tyre is not fitted correctly on the wheel rim, this can lead to the tyre suddenly losing air when driving or bursting and the wheel rim being damaged as a result. This can cause serious accidents and fatal injuries.

- Have tyres fitted on the wheel rims only by a correspondingly qualified workshop. Volkswagen recommends using a Volkswagen dealership.

## Handling wheels and tyres

📖 Please refer to ⚠ at the start of the chapter on page 331.

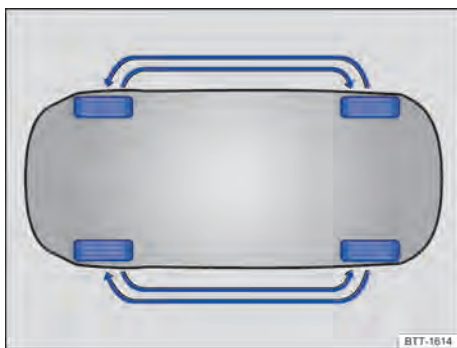

Fig. 241 Illustration: diagram showing how to swap wheels.

The wheels and tyres approved by Volkswagen have been carefully selected.

## Rotating wheels

Regularly rotating the wheels as shown in the illustration → Fig. 241 is recommended to help ensure that tyres wear evenly. All the tyres will then last for about the same time.

Volkswagen recommends having a wheel change carried out by a correspondingly qualified workshop. Volkswagen recommends using a Volkswagen dealership.

## Avoiding damage to the wheel rims and tyres

- Drive over kerbs and other low obstacles slowly and at right angles so that the two front wheels come into contact with the obstacle at the same time.
- Check the tyre pressure regularly.
- Check the tyres for damage such as cuts at regular intervals.
- Never exceed the maximum speed and load permitted for the tyres that are fitted → page 337.
- Damaged or worn tyres must be replaced immediately → page 336.
- Protect the tyres from contact with aggressive substances, including grease, oil, petrol and brake fluid → ⚠.
- Replace missing dust caps on the valves immediately.
- Remove foreign bodies that have not yet penetrated to the inside of the tyre → page 336.
- Observe all warnings of the tyre monitoring system → page 330, → page 330.

## Tyres that are more than six years old

Tyres age through physical and chemical processes that can impair their function. Tyres that have been stored unused for an extended period of time age more quickly than tyres that are used all the time.

Volkswagen recommends replacing tyres that are more than six years old with new tyres. This also applies to tyres which appear to still be in good condition and whose tread depth has not yet reached the minimum value stipulated by legislation → ⚠.

Winter and all-season tyres also largely lose their effectiveness through ageing – regardless of the remaining tread depth.



The age of each tyre can be determined on the basis of the manufacturing date → page 334.

## Storing tyres

- Always store tyres in a cool, dry and preferably dark place.
- Do not store tyres mounted on the rim vertically.

- Any tyres not fitted on rims should be kept in suitable sleeves to protect against dirt and should be stored vertically (standing on the tread).

#### New tyres

- Drive particularly carefully for the first 600 km (370 mi) with new tyres as the tyres have to be *run in*. Tyres that have not been run in have reduced grip →  and braking efficiency → .
- All four wheels must be fitted with tyres of the same type, size, and the same tread pattern.

#### Volkswagen Genuine tyres

The vehicle may be fitted with Volkswagen Genuine tyres at the factory. These tyres are marked with the  symbol and have been especially matched to this vehicle. When used correctly Volkswagen Genuine tyres meet the highest standards with respect to safety and vehicle handling.

#### Replacing tyres

- Always replace tyres at least on an axle-by-axle basis.
- Old tyres should only be replaced by tyres that have been approved by Volkswagen for the vehicle type.
- Never use tyres with an effective size that is larger than Volkswagen-approved tyres → .

#### Re-synchronising the Tyre Pressure Loss Indicator

The Tyre Pressure Loss Indicator must be re-synchronised each time one or more wheels is changed. This also applies if the wheels have been swapped, e.g. from the front to the rear → page 328.

#### Vehicles fitted with a Tyre Pressure Monitoring System

- If you wish to replace factory-fitted wheels, make sure that the new wheels are equipped with sensors that are compatible with the TPM → page 329.
- Drive the vehicle at a speed of over around 25 km/h (15 mph) for an extended period so that the new wheels can be detected.

Volkswagen recommends that a new valve set and set of seals is used every time the sensors are replaced or modified.

Further information on the TPM → page 329.

#### WARNING

Corrosive liquids and other substances can cause visible and invisible damage to the tyres, which can cause the tyre to burst.

- Always keep chemicals, oils, lubricants, fuel, brake fluid and other corrosive substances away from the tyres.

#### WARNING

Even if they have not been used, old tyres can suddenly lose pressure or burst, especially at high speeds, and thus cause accidents and serious injuries.

- Use tyres that are more than six years old only if you have no alternative. In this case, drive slowly and with extra care at all times.

#### WARNING

New tyres will have to be run in as they will initially have reduced grip and braking effect.

- Drive particularly carefully for the first 600 km (370 miles) in order to prevent accidents and serious injury.

#### WARNING

Wheels must have the necessary clearance. If the wheels do not have the necessary clearance, the tyre could rub on parts of the running gear, the vehicle body and the brake lines. This can lead to a fault in the brake system and to tread separation and thus to a tyre bursting.

- The actual tyre size must not exceed the tyre dimensions of manufacturers approved by Volkswagen and must not rub on any vehicle body parts.

#### NOTICE

Avoid strong impacts and drive around obstacles if possible. Tyres can be deformed in particular by potholes and kerb edges. This can cause damage to the tyres and wheel rims.

#### NOTICE

Do not damage the valves when fitting different tyres. Never drive without valve caps. This could cause damage to the valves.



Old tyres should be disposed of properly and as required by legislation.



If the spare tyre is not the same as the tyres that are mounted on the car - for example in the case of winter tyres or a temporary spare wheel - only use the spare tyre in the event of a breakdown for a short period of time and drive with extra care. Replace the temporary spare wheel with a normal wheel as soon as possible.

**i** Volkswagen-approved tyres are guaranteed to have the dimensions that are suitable for the vehicle. In the case of other tyres, the tyre seller must provide a certificate from the tyre manufacturer stating that the tyre is also suitable for the vehicle. Store the certificate in a safe place and keep it in the vehicle. <

## Wheel rims and wheel bolts

**📖 Please refer to ⚠ at the start of the chapter on page 331.**

Wheel rims, tyres and wheel bolts are matched to the vehicle type. If different wheel rims are fitted, the correct wheel bolts with the correct length and correctly shaped bolt heads must be used. This ensures that the brakes work properly and that the vehicle drives quietly and safely.

For technical reasons, it is not generally possible to use the wheel rims from other vehicles. This can also apply to wheel rims of the same vehicle type.

### Wheel bolts

The correct wheel bolts must be used for all vehicle types; these bolts must always be tightened with the correct tightening torque → page 344.

The tightening torque of the wheel bolts must be checked regularly with a properly functioning torque wrench. → page 344.

### Wheel rims with bolted rim rings or trim elements

Rims with bolted-on rings or trim elements consist of several components. These components are joined together using special bolts. Damaged wheel rims must be replaced and must always be repaired only by a correspondingly qualified workshop. Volkswagen recommends using a Volkswagen dealership.

### Wheel rim identification

In some countries, new wheel rims must contain information on certain properties. The following information may be provided on the wheel rim:

- Seal of conformity.
- Rim size.
- Name of manufacturer or brand name.
- Date manufactured (month/year).
- Country of origin.
- Production number.
- Raw materials batch number.
- Product code.

## ⚠ WARNING

The use of unsuitable or damaged wheel rims can impair vehicle safety and cause accidents and serious injury.

- Use only wheel rims that have been approved for the vehicle.
- Check the wheel rims regularly for damage and replace them if necessary.

## ⚠ WARNING

Incorrect loosening and tightening of the bolts on wheel rims with bolted-on rings can cause accidents and serious injury.

- Never loosen the bolts on wheel rims with bolted-on rings.
- Have all work on wheel rims with bolted-on rings carried out by a correspondingly qualified workshop. Volkswagen recommends using a Volkswagen dealership. <

## Tyre pressure

**📖 Please refer to ⚠ at the start of the chapter on page 331.**

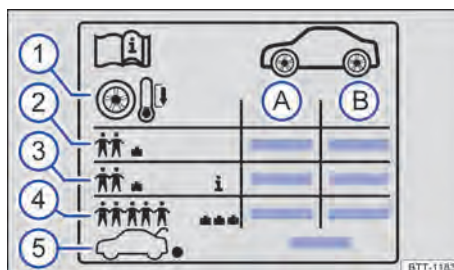

**Fig. 242** Symbols on the tyre pressure sticker.

- (A) Tyre pressure for the tyres on the front axle.
- (B) Tyre pressure for the tyres on the rear axle.
- (1) Note: check the tyre pressure when the tyres are cold.
- (2) Tyre pressure for partial load.
- (3) *Vehicle-dependent*: comfort tyre pressure for partial load.
- (4) Tyre pressure for full load.
- (5) Tyre pressure level for the spare wheel, collapsible spare wheel or temporary spare wheel.



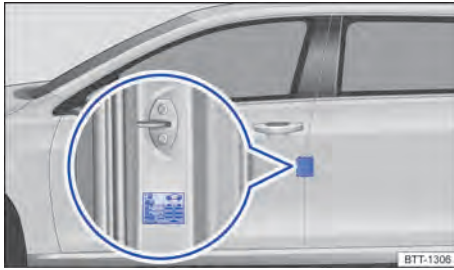

**Fig. 243** On the driver door pillar: tyre pressure sticker (alternatively on the inside of the tank flap).

The sticker provides the correct tyre pressure for approved tyres and is located either on the driver door pillar → Fig. 243 or inside the tank flap.

The appearance of the sticker may differ between vehicles. It may include additional tyre sizes.

The wrong tyre pressure will have a negative effect on the vehicle's response and lead to high levels of wear or even a burst tyre → ⚠. The correct tyre pressure is particularly important at high speeds.

#### Comfort tyre pressure

Depending on the vehicle, the tyre pressure sticker may show details of a comfort tyre pressure → Fig. 242. The comfort tyre pressure allows increased driving comfort. Fuel consumption may increase when driving with comfort tyre pressure.

#### Checking the tyre pressure

- Check the tyre pressure at least once a month.
- Always check the tyre pressure when the tyres are cold. The specified tyre pressure applies to cold tyres. Tyre pressure is always higher in warm tyres than it is in cold tyres. For this reason, never reduce the pressure in warm tyres to adjust the tyre pressure.
- Always adjust the tyre pressure to the load level → Fig. 242.
- After adjusting the tyre pressures, always screw the caps onto the valves and observe the information on the tyre monitoring system.
- Always use the tyre pressure specified on the sticker. Never exceed the maximum tyre pressure which is given on the sidewall of the tyre

#### ⚠ WARNING

Incorrect tyre pressure may cause the tyre to suddenly lose pressure or burst while the vehicle is in motion. This can cause serious accidents and fatal injuries.

- If the tyre pressure is too low, it is possible that the tyre temperature will increase to such an extent when driving that the tread peels off and the tyre bursts.
- Excessive speeds and overloading of the vehicle can cause overheating, sudden tyre damage including tyre bursts and detachment of the tread surface, and thus to a loss of control of the vehicle.
- If the tyre pressure is too low, the tyres will wear prematurely and the car will not handle well.
- Check tyre pressures regularly, at least once a month, and before every long journey.
- The pressure in all tyres must always be appropriate to the vehicle load.
- Never reduce the increased tyre pressure of warm tyres.

#### ⚠ NOTICE

- When attaching the tyre pressure gauge, ensure that you do not position it at an angle to the valve stem. This can damage the tyre valve.
- Always make sure that all valve caps are fully screwed on while driving.

 Underinflated tyres will result in increased fuel consumption. <

#### Tread depth and tread wear indicators

📖 Please refer to ⚠ at the start of the chapter on page 331.



**Fig. 244** Tyre tread: tread wear indicators.

#### Tread depth

Most driving situations require the highest possible tread depth. The tyres should have the same tread

depth, at the minimum on each axle → . This is especially true in wet or wintry road conditions.

In most countries, the minimum tread depth required by law is 1.6 mm (1/16 in), measured in the tread grooves next to the tread wear indicators. Observe any deviating country-specific legal regulations.

Observe any country-dependent legal requirements relating to the permissible minimum tread depths for winter and all-season tyres.

### Tread wear indicators in tyres

The tread wear indicators show if a tyre is worn down. The tyre must be replaced at the latest when the tread depth is just down to the tread wear indicator.



There are 1.6 mm (1/16 in) high wear indicators → [Fig. 244](#) in the tread base of the tyres. Markings on the tyre sidewall indicate the position of the tread wear indicators → [Fig. 244](#).

### WARNING

Worn tyres are a safety risk and can lead to a loss of control of the vehicle and cause serious injury.

- Tyres must be replaced at the latest when the tread is worn down to the tread wear indicators.
- Worn tyres have considerably less grip, particularly on wet roads, which can cause the vehicle to “float” along the road surface (aquaplaning).
- Worn tyres reduce the possibility of controlling the vehicle well in normal and difficult driving situations and increase braking distance and the risk of skidding.

## Tyre damage

 Please refer to  at the start of the chapter on page 331.

Damage to tyres and wheel rims is often hidden → .

1. If you suspect that a wheel is damaged, slow down immediately and stop the vehicle as soon as it is safe to do so.
2. Check the tyres and wheel rims for damage.
3. Do not drive on if a tyre is damaged.
4. Changing a damaged wheel → page 343. Seek expert assistance if necessary.

**Or:** seal damaged wheel with the breakdown set and inflate → page 349.

5. If there is no visible damage, drive slowly and cautiously to the next correspondingly qualified workshop in order to have the vehicle checked. Volkswagen recommends using a Volkswagen dealership.

### Embedded foreign bodies in the tyres

1. Leave the foreign body in the tyre if it has entered the inner tyre. Foreign bodies that are stuck between the tyre tread blocks can be removed.
2. Changing a damaged wheel → page 343. Seek expert assistance if necessary.

**Or:** seal damaged wheel with the breakdown set and inflate → page 349.

3. Check and adjust the tyre pressure.
4. Go to a correspondingly qualified workshop. Volkswagen recommends using a Volkswagen dealership.

### Tyre wear

The tyre wear is affected by several factors:

- Style of driving.
- How well the tyres are balanced.
- Adjustments made to the running gear.

Fast cornering, heavy acceleration and hard braking all increase tyre wear.

Wheel imbalance may develop when the vehicle is driven; you will notice this by the nervous steering response. Unbalanced wheels will affect the level of tyre wear. In this case the wheels should be balanced again.

Incorrect wheel alignment causes excessive tyre wear, impairing the safety of the vehicle. The wheel alignment should be checked by a suitably qualified workshop if tyres show excessive wear. Volkswagen recommends using a Volkswagen dealership.

### WARNING

If you notice unusual vibration or the car pulling to one side while the vehicle is in motion, this may indicate that one of the tyres is damaged.

- Slow down immediately and stop as soon as the traffic situation permits and it is safe to do so.
- Check the tyres and wheel rims for damage.
- Never drive on if tyres or wheel rims are damaged. Seek expert assistance instead.
- If there is no visible damage, drive slowly and cautiously to the nearest suitably qualified workshop in order to have the vehicle checked. Volkswagen recommends using a Volkswagen dealership.

## Tyre lettering and tyre type

Please refer to  at the start of the chapter on page 331.

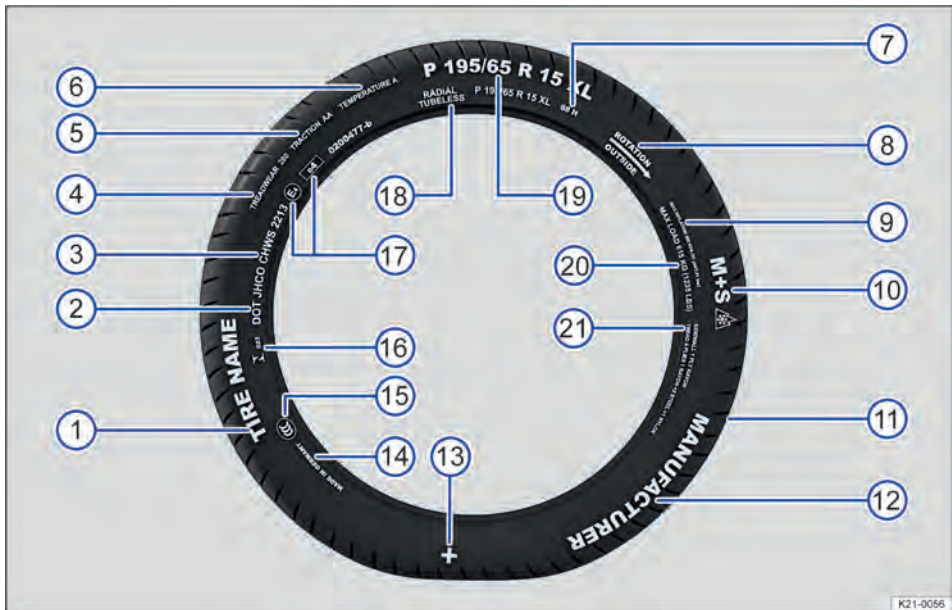





Fig. 245 International tyre lettering.

### → Fig. 245 Tyre lettering (example), meaning

①	Product name	Individual tyre designation of the manufacturer.
②	DOT	The tyre complies with the legal requirements of the USA Department of Transportation, responsible for tyre safety standards.
③	JHCO CHWS 2213	Tyre identification number (TIN <sup>®</sup> ) – may be only on the inner side of the wheel) and date of manufacture:
		JHCO CHWS 2213
Information for the end user concerning comparative values for specified basic tyres (standardised test procedure) → page 365:		
④	TREADWEAR 280	Relative life expectancy for the tyre, with reference to a US-specific standard test. Tyres with the specification 280 wear at a rate of 2.8 times more slowly than standard tyres that have a treadwear value of 100. The performance of tyres is determined by how they are used and can significantly deviate from standard values due to driving style, maintenance, road surface and climatic conditions.
⑤	TRACTION AA	Wet braking performance of the tyre (AA, A, B or C). The wet braking performance is tested under controlled conditions on certified test tracks. Tyres marked C have a low traction performance. The traction value assigned to the tyres is based on linear traction tests and does not include acceleration and lateral stability or aquaplaning and traction under maximum load.

→ Fig. 245 Tyre lettering (example), meaning

⑥	TEMPERATURE A	Temperature stability of the tyre at high speeds on a test bed (A, B or C). A and B tyres exceed legal requirements. The temperature evaluation is based on tyres with correct pressure and does not allow for excess pressure. Excessive speed, incorrect pressure or excess pressure can cause heat build-up or tyre damage. This applies to one or a combination of these factors.	
⑦	88 H	Load index → page 339 and speed index → page 339.	
⑧	Rotation and arrow Or: Outside	Denotes direction of rotation → page 338. Denotes outside of tyres → page 339.	
⑨	MAX INFLATION 350 KPA (51 psi/ 3.51 bar)	US limitation for the maximum air pressure.	
⑩	M+S or M/S or 	Denotes winter tyres (mud and snow tyres) → page 339. Studded snow tyres are labelled with an E after the S.	
⑪	TWI	Indicates the position of the tread wear indicator → page 335.	
⑫	Brand name, logo	Manufacturer.	
⑬		Marking for Volkswagen Genuine tyres → page 332.	
⑭	Made in Germany	Country of manufacture.	
⑮		Country-dependent identification for China (China Compulsory Certification).	
⑯	 023	Country-dependent identification for Brazil.	
⑰	E4 e4 0200477-b	Indicates conformity with international regulations with the number of the country that granted approval. Approved tyres which comply with ECE regulations are identified with E, tyres which comply with EC regulations are identified with e. This is followed by the multiple-digit approval number.	
⑱	RADIAL TUBELESS	Tubeless radial tyre.	
⑲	P 195 / 65 R 15 XL	Size designation:	
		P	Identification for passenger vehicle.
		195	Tyre width from wall to wall in mm.
		65	Aspect ratio in %.
		R	Tyre construction: radial.
		15	Rim diameter in inches.
⑳	MAX LOAD 615 KG (1235 LBS)	US load data for the maximum load per wheel.	
	SIDEWALL 1 PLY RAYON	Details of the tyre carcass components: 1 ply of rayon (artificial silk).	
㉑	TREAD 4 PLYS 1 RAYON + 2 STEEL + 1 NYLON	Details of the tread components: In the example there are 4 plies under the tread surface: 1 ply of rayon (artificial silk), 2 steel belt plies and 1 nylon ply.	

a) The TIN is the tyre serial number.

The tyre lettering is located on both sides. Certain labels may only be found on one side of the tyre, e.g. tyre identification number and manufacturing date.

Any further numbers and letters are internal codes used by the tyre manufacturer or country-specific codes.

### Low-profile tyres

Low-profile tyres have a wider tread surface, larger rim diameter and lower sidewalls than conventional

wheel/tyre combinations → page 332. Low-profile tyres can improve the vehicle's handling and precision. They may however result in a less comfortable ride on uneven road surfaces and tracks.

### Tyres with directional tread pattern

An arrow on the tyre sidewall indicates the direction of rotation on tyres with directional tread. The direction of rotation must be observed in all cases. This guarantees the best possible running characteristics.

If, however, the tyre is fitted in the opposite direction to the tread pattern, you must take more care when driving as the tyre is now no longer being used according to its designation. The tyres must be replaced as quickly as possible or be fitted with the tread in the correct direction.

### Asymmetrical tyres

Asymmetrical tyres take into account the differing behaviour of the inner and outer areas of the tread pattern. The sidewalls of asymmetrical tyres are marked to indicate "inside" or "outside". Always observe the correct tyre position on the wheel rim.

### Tyre load

The load index indicates the maximum load capacity of an individual tyre in kilograms (tyre load).

Examples:

<b>78</b>	425 kg (936 lbs)
<b>81</b>	462 kg (1018 lbs)
<b>83</b>	487 kg (1073 lbs)
<b>85</b>	515 kg (1135 lbs)
<b>87</b>	545 kg (1201 lbs)
<b>88</b>	560 kg (1234 lbs)
<b>91</b>	615 kg (1355 lbs)
<b>92</b>	630 kg (1388 lbs)
<b>93</b>	650 kg (1433 lbs)
<b>95</b>	690 kg (1521 lbs)

<b>97</b>	730 kg (1609 lbs)
<b>99</b>	775 kg (1708 lbs)
<b>100</b>	800 kg (1763 lbs)
<b>101</b>	825 kg (1818 lbs)
<b>102</b>	850 kg (1873 lbs)
<b>103</b>	875 kg (1929 lbs)
<b>104</b>	900 kg (1984 lbs)

### Speed index

The speed index indicates the maximum permitted speed that may be driven with the tyre.

<b>P</b>	max. 150 km/h (93 mph)
<b>Q</b>	max. 160 km/h (99 mph)
<b>R</b>	max. 170 km/h (106 mph)
<b>S</b>	max. 180 km/h (112 mph)
<b>T</b>	max. 190 km/h (118 mph)
<b>U</b>	max. 200 km/h (125 mph)
<b>H</b>	max. 210 km/h (130 mph)
<b>V</b>	max. 240 km/h (149 mph)
<b>W</b>	max. 270 km/h (168 mph)
<b>Y</b>	max. 300 km/h (186 mph)
<b>Z</b>	above 240 km/h (149 mph)

Some tyre manufacturers use the code "ZR" for tyres with a maximum permitted speed of over 240 km/h (149 mph). <

## Maximum load and speed range for tyres

☞ Please refer to ▲ at the start of the chapter on page 331.

Vehicles in the EU and the so-called EU user states are issued an EC Certificate of Conformity. This details the size, diameter and speed range of all tyres approved by Volkswagen for the relevant vehicle type.

The type plate shows whether there is an EC Certificate of Conformity for this particular vehicle  
→ page 388.

- If the type plate has a row marked "Permit" then the vehicle has an EC Certificate of Conformity.
- If there is no type plate, or no row marked "Permit" the vehicle does not have an EC Certificate of Conformity. <

## Winter tyres

☞ Please refer to ▲ at the start of the chapter on page 331.

Summer tyres have less grip on icy or snow-covered roads. Winter or all-season tyres improve the handling and braking characteristics in winter road conditions. Volkswagen recommends that winter tyres be fitted to the vehicle at temperatures below +7°C (+45°F) or in winter road conditions.

Winter and all-season tyres lose their effectiveness when the tread is worn down to a depth of 4 mm (3/16 inches).

### The following applies when using winter tyres:

- Observe any country-specific legal requirements.
- Use winter tyres on all four wheels at the same time.
- Only use in winter road conditions.

- Only use the sizes of tyre that have been approved for the vehicle.
- Winter tyres must have the same belt type, size and the same tread pattern.
- Observe the maximum speed permitted by the speed index → page 340.

### Speed limitation

Winter tyres have a speed limit depending on the speed index → page 337.

You can set a speed warning using the **Vehicle settings** and the **Tyres** menus in the Infotainment system.

If you use V-rated winter tyres, the speed limits and required tyre pressure are determined by the engine size. You must ask a correspondingly qualified workshop about the maximum permitted speed and required tyre pressure. Volkswagen recommends using a Volkswagen dealership.

### All-wheel drive (4MOTION)

Thanks to its all-wheel drive, the vehicle will have plenty of traction in winter conditions, even with the standard tyres. Nevertheless, Volkswagen still recommends that winter tyres or all-year tyres should be fitted *on all four wheels* in winter, above all because this will give improved *braking efficiency*.

Observe information on snow chains → page 340.

### WARNING

The improved winter driving characteristics afforded by the winter tyres should not encourage you to take any risks.

Exceeding the speed limitation of winter tyres can cause the tyres to fail suddenly and the vehicle to lose control.

- Never disregard the speed limitation of the winter tyres fitted, even if the permissible top speed of the vehicle is higher.
- Never exceed the maximum load capacity of the winter tyres that are fitted.
- Adapt your speed and driving style to the current visibility, weather and road or traffic conditions.

 The vehicle handling is better if summer tyres are fitted at temperatures above +7°C (+45°F). The rolling noise is quieter, the tyre wear lower and the energy efficiency higher in this case.



 In vehicles with a Tyre Pressure Loss Indicator, the system has to re-synchronise after wheels are changed → page 328.

 On vehicles with Tyre Pressure Monitoring System, winter tyres must be fitted with com-

patible sensors for the Tyre Pressure Monitoring System to ensure the system works properly → page 330. If the dimensions of the winter tyres are different from those of the summer tyres and require a different tyre pressure, the tyre pressure values for the Tyre Pressure Monitoring System must be adjusted → page 329.

 Ask a correspondingly qualified workshop about the permitted winter tyre sizes. Volkswagen recommends using a Volkswagen dealership. <

## Snow chains

 Please refer to  at the start of the chapter on page 331.

Please observe legislation and also the maximum permitted speed when driving your vehicle with snow chains.

On icy or snow-covered roads, snow chains will improve traction and braking response.

Snow chains may be fitted only to the front wheels. They may be fitted only to the following tyre and wheel combinations:

Tiguan		
Tyre size	Wheel rim	Type of snow chains to use
215/65 R 17	6 1/2 J x 17 ET 38	Only fine-linked snow chains that add no more than about <b>13.5 mm</b> .
	7 J x 17 ET 40	Only fine-linked snow chains that add no more than about <b>9 mm</b> .
235/55 R 18	7 J x 18 ET 43	Only tread snow chains that do not have any chain links on the inner side but have chain links only on the tyre tread and do not add more than about <b>12 mm</b> .

Tiguan R		
Tyre size	Wheel rim	Type of snow chains to use
235/50 R 19	7 J x 19 ET 43	Only tread snow chains that do not have any chain links on the inner side but have chain links only on the tyre tread and do not add more than about <b>12 mm</b> .

Volkswagen recommends that you ask a correspondingly qualified workshop for information about appropriate wheel, tyre and snow chain sizes. Volkswagen recommends using a Volkswagen dealership.

Snow chains may only be used on tyre and wheel combinations that are approved for driving with snow chains.

Remove hubcaps and trim rings before fitting snow chains. For safety reasons, cover caps must then be fitted over the wheel bolts. Caps are available from a correspondingly qualified workshop. Volkswagen recommends using a Volkswagen dealership.

#### Using snow chains with fitted temporary spare wheel or collapsible spare wheel

For technical reasons, snow chains must not be used on the temporary spare wheel or collapsible spare wheel → page 346.

1. In event of a flat tyre on one of the front wheels, fit the temporary spare wheel or collapsible spare wheel on the rear axle.
2. Replace the damaged front wheel with the removed rear wheel. Observe the direction of rotation.

Volkswagen recommends fitting the snow chains before fitting the wheel.

#### **⚠ WARNING**

The use of snow chains that are unsuitable for your vehicle or the incorrect installation of snow chains can cause accidents and serious injuries.

- Always use the correct snow chains.
- Observe the fitting instructions of the snow chain manufacturer.
- Never drive faster than permitted when snow chains are fitted.

#### **ⓘ NOTICE**

- Remove the snow chains when driving on roads that are clear of snow. The snow chains will otherwise impair handling, damage the tyres and wear out very quickly.
- Snow chains that are in direct contact with the wheel rim can scratch or damage it. Volkswagen recommends using snow chains with built-in rim protection.

**ⓘ** In vehicles with a Tyre Pressure Loss Indicator, the system must be re-synchronised when snow chains are fitted → page 328. ◀

## Hubcaps

### Centre wheel trim

Vehicles with centre wheel trims that can be removed by pulling off



**Fig. 246** Removing the centre wheel trim by pulling off.

The centre wheel trim protects the wheel bolts and must be fitted again after changing the wheel.

1. *To remove:* take the puller from the vehicle toolkit → page 292 and insert it into a hole (alloy wheel) or fit it on the edge (steel wheel) of the trim → Fig. 246.
2. Pull off the cover in the direction of the arrow.
3. *To fit:* press the centre wheel trim against the rim until you feel it engage.

#### **⚠ WARNING**

Using unsuitable hubcaps, or fitting them incorrectly, can cause accidents and serious injuries.

Incorrectly fitted hubcaps can become loose while the vehicle is in motion and endanger other road users.

- Do not use damaged hubcaps.
- Always make sure that the air flow to cool the brakes is not restricted or reduced. This also applies if hubcaps are retrofitted. If the airflow is not sufficient, the braking distance could increase significantly.

Incorrectly fitted hubcaps can become loose while the vehicle is in motion and endanger other road users.

- Do not use damaged hubcaps.
- Always make sure that the air flow to cool the brakes is not restricted or reduced. This also applies if hubcaps are retrofitted. If the airflow is not sufficient, the braking distance could increase significantly.

## Wheel cover

### Removing wheel covers



Fig. 247 Removing the wheel cover.

The wheel cover protects the wheel bolts and must be fitted again after changing the wheel.

1. Take the puller from the vehicle toolkit → page 292.
2. Insert the puller into one of the holes in the wheel cover.
3. Use the puller to pull off the wheel cover in the direction of the arrow. If necessary, use a box spanner to do this → Fig. 247.

### Fitting wheel covers

1. Check the correct position of the anti-theft wheel bolt → page 344.
2. Press the wheel cover onto the wheel rim so that the valve hole is located over the tyre valve. Please ensure the cover engages securely all the way round.

## ⚠ WARNING

Using unsuitable hubcaps, or fitting them incorrectly, can cause accidents and serious injuries.

## ⓘ NOTICE

The wheel cover can be firmly fixed and should not be removed using force.

## Wheel bolt caps



Fig. 248 Removing the wheel bolt caps.

The caps protect the wheel bolts and should be fitted fully back in position after changing the wheel.

### Removing and fitting the caps

1. *Removing:* take the puller from the vehicle toolkit → page 292.
2. Insert the puller through the opening in the cap → Fig. 248 and pull off in the direction of the arrow.
3. *Fitting:* press the caps onto the bolts as far as they will go.

The anti-theft wheel bolt has a separate cap. It only fits onto the anti-theft wheel bolt and not onto the conventional wheel bolts.



# Changing a wheel

## Introduction to the topic

You should carry out a wheel change yourself only when the vehicle is parked safely, you are familiar with the safety procedures and have access to the correct equipment. Some models are delivered from the factory without a jack or box spanner. If this is the case, have the wheel change carried out by a suitably qualified workshop. Volkswagen recommends using a Volkswagen dealership.

The jack supplied with the vehicle is only designed for changing a wheel when one vehicle tyre is damaged and has to be replaced. If both tyres on one side of the vehicle, both tyres on one axle, or all tyres are damaged, go to a suitably qualified workshop. Volkswagen recommends using a Volkswagen dealership.

### WARNING

Changing a wheel can be dangerous, especially when carried out at the side of a road. Please note the following steps in order to reduce the risk of serious injuries:

- Stop the vehicle as soon as possible and when safe to do so. To change the wheel, park the vehicle at a safe distance from moving traffic.
- All passengers and children in particular must be at a safe distance and away from the area of work during the wheel change.
- Switch on the hazard warning lights to warn other road users.
- Make sure that the surface the vehicle is parked on is level and firm. If necessary, use a large, strong board or similar support for the jack.
- Change the wheel yourself only if you are familiar with the necessary actions. Otherwise, seek assistance from a suitably qualified workshop. Volkswagen recommends using a Volkswagen dealership.
- Always use suitable and undamaged tools to change the wheel.
- To reduce the risk of unintended vehicle movement, always switch off the engine and move the selector lever to P position.

Select a gear on vehicles with a manual gearbox in order to reduce the risk of unintended vehicle movement.

- Apply the electronic parking brake.
- The wheel bolt tightening torque should be checked with a correctly functioning torque wrench immediately after changing a wheel.

- If your vehicle is equipped with a Tyre Pressure Loss Indicator, you must immediately adapt the system again after a wheel change → page 328. <

## Preparations for changing a wheel

📖 Please refer to ⚠ at the start of the chapter on page 343.

### Checklist

The following actions must always be carried out in the given order in preparation for changing the wheel → ⚠:

1. If your vehicle has a flat tyre, park the vehicle on a firm and level surface at a safe distance from moving traffic.
2. Switch on the electronic parking brake.
3. Automatic gearbox: move the selector lever to position P.
4. Stop the engine and switch off the ignition.
5. Remove the vehicle key from the ignition lock.
6. Manual gearbox: select a gear.
7. Ask all vehicle occupants to leave the vehicle and stand at a safe distance away from moving traffic.
8. Switch on the hazard warning lights and set up the warning triangle → page 65. Observe any legal requirements.
9. Chock the wheel diagonally opposite the wheel being worked on with a stone, collapsible chocks or another suitable object.
10. When towing a trailer: unhitch the trailer from the vehicle and park it properly → page 273.
11. Remove any items of luggage from the luggage compartment.
12. Remove the collapsible spare wheel, spare wheel or temporary spare wheel and the vehicle toolkit from the luggage compartment.
13. Remove the hubcaps → page 341.

### WARNING

Ignoring any of the items on this important safety checklist can lead to accidents and severe injuries.

- Always observe the items on the checklist.
- Observe the generally valid safety precautions. <

## Wheel bolts

📖 Please refer to ⚠️ at the start of the chapter on page 343.

### Loosening wheel bolts



Fig. 249 Changing a wheel: loosening the wheel bolts.

Use a suitable box spanner to loosen the wheel bolts.

Only loosen the wheel bolts by approximately one turn before raising the vehicle with the jack.

1. Fit the box spanner over the wheel bolt as far as it will go → Fig. 249.
2. Hold the end of the box spanner and turn the wheel bolt one turn anticlockwise → ⚠️.

**Or:** if one of the wheel bolts is very tight, you may be able to loosen it by pushing down the end of the box spanner carefully with your foot. Hold on to the vehicle for support and ensure that you have a secure footing.

### Loosening the anti-theft wheel bolt

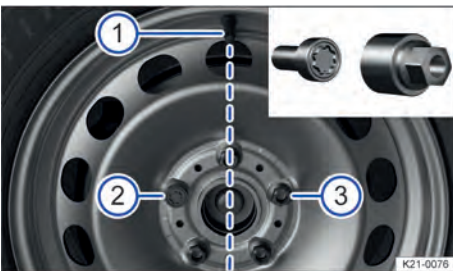

Fig. 250 Changing a wheel: tyre valve ① and locations of the anti-theft wheel bolt ② or ③.

1. Take the adapter for the anti-theft wheel bolt out of the vehicle toolkit.

2. Insert the adapter into the anti-theft wheel bolt as far as it will go.
3. Push the box spanner onto the adapter as far as it will go.
4. Hold the end of the box spanner and turn the wheel bolt one turn anticlockwise → ⚠️.

### Screwing in the anti-theft wheel bolt (wheel cover)

On wheels with a wheel cover, the anti-theft wheel bolt must be screwed in at position → Fig. 250 ② or ③ according to the position of the tyre valve ①. The wheel cover can otherwise not be fitted.

### Tightening torque for wheel bolts

Specified tightening torque for wheel bolts for steel or alloy wheel rims:

– 140 Nm (103 ft-lbs).

If the wheel bolts are corroded and stiff, they must be renewed and the wheel hub threads cleaned before the tightening torque is checked.

Never grease or oil the wheel bolts or the threads of the wheel hubs.

The tightening torque should be checked with a properly functioning torque wrench immediately after changing a wheel.

### ⚠️ WARNING

Incorrectly tightened wheel bolts can loosen while the vehicle is in motion and cause accidents, serious injury, and loss of control of the vehicle.

- The wheel bolts and threads of the wheel hubs must be clean, free from oil and grease, and turn easily.
- Always use the box spanner placed in the vehicle at the factory to loosen and tighten the wheel bolts.
- Only loosen the wheel bolts by approximately one turn before raising the vehicle with the jack.
- Never grease or oil the wheel bolt and the threads in the wheel hubs. This could cause them to loosen while the vehicle is in motion, even if the required torque setting is used.
- Never loosen the bolts on wheel rims with bolted-on rings.
- Regularly check the tightening torque with a torque wrench. If the tightening torque of the wheel bolts is too low, the wheel bolts and rims can loosen while the vehicle is in motion. The wheel bolts and the threads could be damaged if the tightening torque is too high.

## **⚠ WARNING**

The wrong wheel bolts can loosen while the vehicle is in motion and cause accidents, serious injury, and loss of control of the vehicle.

- Use only wheel bolts that belong to the respective wheel rim.
- Never use different wheel bolts.

## **Subwoofer**

☐ Please refer to **⚠** at the start of the chapter on page 343.

The subwoofer must be removed before the spare wheel can be taken out.

### **Removing the subwoofer (type 1)**

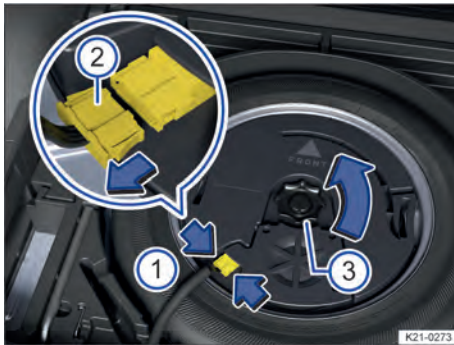

**Fig. 251** In the luggage compartment: removing subwoofer (type 1).

1. Fold up or remove the luggage compartment floor → page 267.
2. To release the connector → Fig. 251 ②, press the lugs together (arrows ①).
3. Pull off the connector → Fig. 251 ③ as shown by the arrow, and place the disconnected electrical cable to one side.
4. Unscrew handwheel → Fig. 251 ③ in the direction of the arrow.
5. Lift out the subwoofer carefully.

### **Installing the subwoofer (type 1)**

1. Place the subwoofer carefully in the rim base. The tip of the arrow symbol "FRONT" on the subwoofer must face forwards.
2. Plug in connector → Fig. 251 ② until it audibly engages.

3. Screw the handwheel → Fig. 251 ③ onto the threaded pin in the opposite direction to the arrow until the subwoofer is secured in place.
4. Place the variable luggage compartment floor on the floor covering.

### **Removing the subwoofer (type 2)**

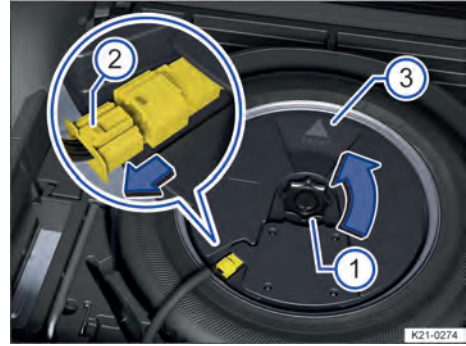

**Fig. 252** In the luggage compartment: removing subwoofer (type 2).

1. Lift up the variable luggage compartment floor until it is held in position by the side restraints.
2. Unscrew handwheel → Fig. 252 ① in the direction of the arrow.
3. To unlock the connector, press the catch on the end of the plug → Fig. 252 ②.
4. Pull off the connector as shown by the arrow, and place the disconnected electrical cable to one side.
5. Lift out the subwoofer carefully.

### **Installing the subwoofer (type 2)**

1. Place the subwoofer carefully in the rim base. The tip of the arrow symbol "FRONT" → Fig. 252 ③ on the subwoofer must face forwards.
2. Plug in connector → Fig. 252 ② until the catch audibly engages.
3. Screw the handwheel → Fig. 252 ① onto the threaded pin in the opposite direction to the arrow until the subwoofer is secured in place.
4. Place the variable luggage compartment floor on the floor covering.

## Spare wheel or temporary spare wheel

📖 Please refer to ⚠️ at the start of the chapter on page 343.



Fig. 253 In the luggage compartment: handwheel for securing the spare wheel.

### Removing the spare wheel, collapsible spare wheel or temporary spare wheel

1. Open the boot lid.
2. Fold up or remove the luggage compartment floor → page 267.
3. If necessary, lift up the floor covering and remove.
4. Remove the vehicle toolkit with the container.
5. Pull out the wedge of the locating element → Fig. 253 ① in upward direction.
6. Fully unscrew the handwheel in middle of the spare wheel → Fig. 253 ② in an anticlockwise direction.
7. Remove the spare wheel, collapsible spare wheel or temporary spare wheel.

### Stowing the removed wheel

1. Open the boot lid.
2. Fold up or remove the luggage compartment floor → page 267.
3. If necessary, lift up the floor covering and remove.
4. Place the removed wheel into the spare wheel well with the rim facing downwards so that the centre hole in the rim is positioned exactly above the hole or threaded pin.
5. Screw the handwheel clockwise onto the threaded pin until the replaced wheel is firmly secured.

6. Insert the wedge of the locating element → Fig. 253 ① into the slot of the threaded pin so that the handwheel can no longer be turned.
7. Return the vehicle toolkit to the container and stow the container in the luggage compartment.
8. Place the floor covering in the luggage compartment if necessary.
9. Replace the luggage compartment floor → page 267.
10. Close the boot lid.

### If the spare wheel tyre is not the same as the tyres on the vehicle

If the spare wheel tyre differs from the other tyres on the vehicle, the spare wheel must be used only in the event of a tyre failure and for a short time → ⚠️.

#### Observe these driving guidelines:

- Do not drive faster than 80 km/h (50 mph).
- Avoid full acceleration, sudden braking and fast driving through bends in the road.
- Do not use snow chains on the temporary spare wheel → page 340.
- The tyre pressure must be checked as soon as possible after fitting the spare wheel or temporary spare wheel → page 334.

The tyre pressure of the spare wheel, space-saving spare wheel or temporary spare wheel must be checked each time the tyre pressure of the tyres in use is checked, at least once a month. The tyre pressure of cold spare wheels, space-saving spare wheels or temporary spare wheels must correspond to the information on the tyre pressure sticker. → page 334

### ⚠️ WARNING

Incorrect use of the spare wheel or temporary spare wheel can lead to a loss of control over the vehicle, collisions or other accidents and cause serious injuries.

- Do not use the spare wheel or temporary spare wheel under any circumstances if it is damaged or worn down to the tread wear indicators.
- Some vehicles may be equipped with a temporary spare wheel instead of a spare wheel. The temporary spare wheel can be recognised by a sticker and the text “80 km/h” or “50 mph”. This is the maximum speed at which you are permitted to drive with this tyre. Do not cover the sticker during use of the wheel.
- Never drive faster than 80 km/h (50 mph).

- Never drive further than 200 km (125 miles) with a temporary spare wheel if it is fitted to the drive axle.
- Do not accelerate quickly, brake suddenly or drive at high speed through bends.
- Replace the temporary spare wheel with a normal wheel as soon as possible. The temporary spare wheel is designed for a short period of use only.
- Always secure the temporary spare wheel with the wheel bolts supplied from the factory.
- Never drive using more than one spare wheel that differs from the normal tyres.
- After fitting the temporary spare wheel, check the tyre pressure as quickly as possible → page 334.
- Do not use snow chains on the temporary spare wheel.
- Do not fit a temporary spare wheel to the rear axle when towing a trailer → page 273.

## Lifting the vehicle with the jack

📖 Please refer to ⚠ at the start of the chapter on page 343.

### Jacking points



Fig. 254 Jacking points (illustration).

The jack may be positioned only at the reinforcements on the underbody, which are located behind the markings on the body → Fig. 254. Always use the jacking point closest to the wheel you are working on → ⚠.

### Applying the jack

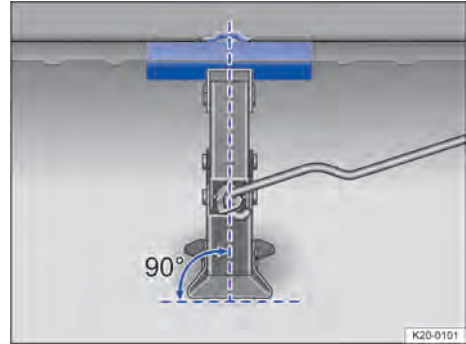

Fig. 255 Correct alignment of the jack.

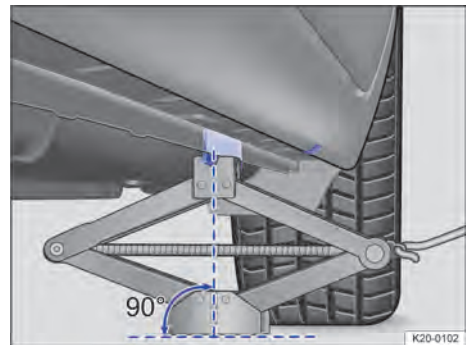

Fig. 256 Jack applied at the rear left-hand side of the vehicle.

### Checklist

For your own safety, carry out the following points in the specified order → ⚠:

1. Choose a firm and level surface suitable for lifting the vehicle.
2. Adjust the steering wheel so that the wheels point straight forwards.
3. Switch off the engine.
4. Move the automatic gearbox selector lever to position P.

**Or:** engage a gear on vehicles with manual gearbox.

5. Switch on the electronic parking brake.
6. Chock the wheel diagonally opposite using collapsible chocks or other suitable objects.
7. When towing a trailer → page 273: unhitch the trailer from the vehicle and park it properly.
8. Loosen the wheel bolts → page 344.

9. Insert the hand crank into the opening on the jack.
10. Find the jacking point under the vehicle → Fig. 254 which is closest to the wheel that is being changed.
11. Crank up the jack until it just fits under the jacking point of the vehicle.
12. Make sure that the entire surface of the foot of the jack is resting securely on the ground and that the foot of the jack is positioned vertically directly beneath the jacking point → Fig. 255 and → Fig. 256.
13. Position the jack and simultaneously continue to crank the claw up until it is in position around the jacking point underneath the vehicle → Fig. 256.
14. Crank the jack further until the wheel is just clear of the ground.

### **⚠ WARNING**

Incorrect use of the vehicle jack can cause the vehicle to slip off the jack, which can lead to severe injuries. Please note the following to help reduce the risk of injuries:

- Do not jack up the vehicle if more than one tyre is damaged.
- Never jack up the vehicle when the engine is running, or if the vehicle is tilted to the side or on a gradient.
- Never start the engine when the vehicle is jacked up. Engine vibrations can cause the vehicle to fall off the jack.
- Fit the jack only at the described jacking points. The jack claw must grip the vertical rib under the side member securely → Fig. 256.
- Use only vehicle jacks that have been approved by Volkswagen for your vehicle. Other vehicle jacks could slip out of position – this includes vehicle jacks supplied with other Volkswagen models.
- The ground must be firm and level. Soft ground or surfaces at an incline under the vehicle jack may cause the vehicle to slip off the jack. If necessary, use a large, strong board or similar support for the jack.
- To prevent the jack from slipping, place the jack on an anti-slip surface such as a rubber mat when it is used on a slippery surface such as tiles.
- Never place any part of your body, e.g. your arm, underneath the vehicle if the latter is only supported by the jack.

- If you have to work underneath the vehicle, use suitable stands to provide extra support for the vehicle.

### **⚠ WARNING**

Ignoring any of the items on this important safety checklist can lead to accidents and severe injuries.

- Always follow the actions in the checklist and observe the generally valid safety precautions. <

## Changing a wheel

☞ Please refer to **⚠** at the start of the chapter on page 343.

### Removing the wheel



**Fig. 257** Wheel change: Unscrew the wheel bolts with the wheel wrench.

1. Observe the checklist → page 343.
2. Loosen the wheel bolts → page 344.
3. Jack up the vehicle → page 347.
4. Using the wheel wrench → Fig. 257, completely unscrew loosened wheel bolts and place them on a clean surface.
5. Remove the wheel.

### Fitting the spare wheel or temporary spare wheel

1. Note the tyre direction of rotation → page 337.
2. Put the wheel in place.
3. Use the adapter to screw the anti-theft wheel bolt clockwise to the correct position and tighten it slightly → page 344.
4. Screw in all the other wheel bolts in clockwise direction and tighten them slightly.
5. Lower the vehicle with the jack.

6. Use the box spanner to tighten all the wheel bolts securely in a clockwise direction → . Do not tighten the bolts in clockwise or anticlockwise sequence. Tighten them in diagonal sequence.
7. Fit the caps, wheel centre trim or wheel cover → page 341.

#### After changing a wheel

1. Clean the tools and place them back in the foam rubber holder in the luggage compartment.
2. Stow the changed wheel securely in the luggage compartment.
3. Have the tightening torque of the wheel bolts checked immediately → page 344.
4. The damaged wheel should be replaced as soon as possible.

#### WARNING

Incorrect torque or incorrect use of wheel bolts can lead to a loss of control of the vehicle, cause accidents and serious injuries.

- Always keep all wheel bolts and threads in the wheel hubs clean and free from oil and grease. The wheel bolts must be easy to turn and be tightened to the specified torque.

 After changing a wheel, the indicator lamp for the tyre monitoring system may indicate a fault in the system → page 330, → page 330.

 If the dimensions of the new tyres are different from those of the tyres removed and require a different tyre pressure, the tyre pressure values for the Tyre Pressure Monitoring System must be adjusted → page 329.

## Breakdown set

### Introduction to the topic

The breakdown set can be used to temporarily and reliably seal any tyre damage caused by foreign bodies or punctures (up to approx. 4 mm in diameter). Do not remove foreign objects (e.g. screws) from the tyre!

Once the sealant has been added to the tyre, the tyre pressure must be checked and adjusted again after approximately 10 minutes of driving.

Seek expert assistance if more than one of the vehicle's tyres is damaged. The breakdown set is designed to fill only one tyre.

Use the breakdown set only when the vehicle has been safely parked and you are familiar with the work and safety precautions needed. Otherwise seek expert assistance.

#### The tyre sealant must not be used:

- If the wheel rim is damaged.
- If the outside temperature is below -20°C (-4°F).
- If there are cuts or punctures in the tyre that are larger than 4mm.
- If the vehicle was driven with very low tyre pressure or a flat tyre.
- If the use-by date on the tyre filler bottle has expired.
- If a foreign object has been removed from the tyre.

#### WARNING

Using the breakdown set can be dangerous, especially if the tyre is inflated at the roadside. Please note the following steps in order to reduce the risk of serious injuries:

- Stop the vehicle as soon as possible and when safe to do so. To inflate the tyre, park the vehicle at a safe distance from moving traffic → page 65.
- Make sure that the surface the vehicle is parked on is level and firm.
- All passengers, and children in particular, must be at a safe distance and away from your area of work.
- Switch on the hazard warning lights to warn other road users.
- Only use the breakdown set if you are familiar with what is required. Otherwise seek expert assistance.
- Tyres repaired with the breakdown set are intended for temporary, emergency use only. They should be used only until you can reach the nearest qualified workshop. Volkswagen recommends using a Volkswagen dealership.
- Tyres that have been repaired using the breakdown set should be replaced as soon as possible.
- If your skin comes into contact with the sealant, wipe it off immediately. The sealant poses a health hazard.
- Keep the breakdown set out of the reach of children.
- When using the breakdown set, never lift the vehicle with a jack, even if the jack is approved for the vehicle.

## ⚠ WARNING

Tyres that have been filled with sealant will not handle in the same way as a standard tyre.

- Never drive faster than 80 km/h (50 mph).
- Do not accelerate quickly, brake suddenly or drive at high speed through bends.
- Drive at a maximum of 80 km/h (50 mph) for no longer than 10 minutes before stopping to check the tyre.

🍃 Dispose of used or out-of-date sealant in accordance with legal requirements.

**i** You can purchase a new tyre filler bottle from a suitably qualified workshop. Volkswagen recommends using a Volkswagen dealership.

**i** Observe the separate operating instructions provided by the manufacturer of the breakdown set.

## Contents of the breakdown set

📖 Please refer to ⚠ at the start of the chapter on page 349.

The breakdown set is located underneath the floor covering in the luggage compartment.

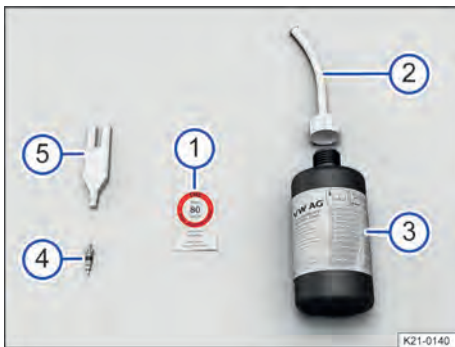

Fig. 258 Illustration: components of the breakdown set.

- ① Sticker with the maximum permitted speed "max. 80 km/h" or "max. 50 mph".
- ② Tyre sealant tube with plug.
- ③ Tyre filler bottle.
- ④ Spare valve core.
- ⑤ Valve core extractor.

There is a slot on the lower end of the valve core extractor → Fig. 258 ⑤ for the valve core. This is required for extracting the valve core from the tyre valve and then screwing it back into the valve again. This also applies to the spare valve core ④.

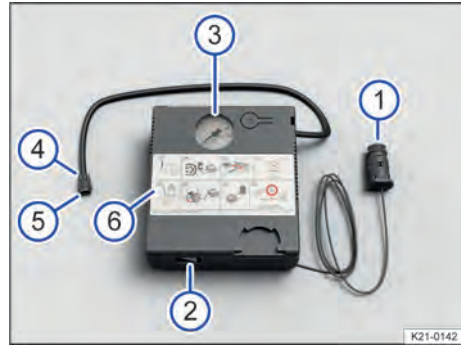

Fig. 259 Illustration: compressor from the breakdown set.

- ① 12-volt plug.
- ② ON/OFF switch.
- ③ Tyre pressure display.
- ④ Air bleed screw.
- ⑤ Tyre filler hose.
- ⑥ Air compressor.

**i** The air compressor from the breakdown set may be operated from the 12-volt socket, even if the power stated on the type plate of the air compressor exceeds the maximum power of the socket.

**i** There may also be a button on the air compressor instead of the air bleed screw.

## Preparations

📖 Please refer to ⚠ at the start of the chapter on page 349.

### Checklist

Always carry out the following actions in the given order → ⚠:

1. If your vehicle has a flat tyre, park the vehicle on a firm and level surface at a safe distance from moving traffic.
2. Switch on the electronic parking brake.





3. Automatic gearbox: move the selector lever to position P .
4. Stop the engine and switch off the ignition.
5. Remove the vehicle key from the ignition lock.
6. Manual gearbox: select a gear.
7. Ask all vehicle occupants to leave the vehicle and stand at a safe distance away from moving traffic.
8. Switch on the hazard warning lights and set up the warning triangle → page 65. Observe any legal requirements.
9. Check whether the puncture can be repaired with the breakdown set → page 349.
10. When towing a trailer: unhitch the trailer from the vehicle and park it properly → page 273.
11. Remove any items of luggage from the luggage compartment.
12. Take the breakdown set out of the luggage compartment.
13. Take the sticker from the breakdown set and stick it on the dash panel within the driver's field of vision → page 350.
14. Do not remove the foreign object, e.g. a screw, from the tyre.

### WARNING

Ignoring any of the items on this important safety checklist can lead to accidents and severe injuries.

- Always follow the actions in the checklist and observe the generally valid safety precautions.

## Sealing and inflating tyres



 Please refer to  at the start of the chapter on page 349.

### Sealing a tyre

1. Unscrew the cap from the tyre valve.
2. Use the valve core extractor → Fig. 258 ⑤ to screw the valve core out of the tyre valve. Place the core on a clean surface.
3. Shake the tyre filler bottle → Fig. 258 ③ vigorously up and down several times.
4. Screw the tyre filler hose → Fig. 258 ② tightly onto the tyre filler bottle in a clockwise direction. The seal on the top of the bottle is pierced when doing so.

5. Remove the plug from the tyre filler hose → Fig. 258 ② and place the open end fully on the tyre valve.
6. Hold the bottle upside down and fill the entire contents of the tyre filler bottle into the tyre.
7. Remove the empty tyre filler bottle from the valve.
8. Use the valve core extractor → Fig. 258 ⑤ to screw the valve core back into the tyre valve.

### Inflating the tyre

1. Screw the tyre filler hose → Fig. 259 ⑤ of the air compressor tightly onto the tyre valve.
2. Make sure that the air bleed screw → Fig. 259 ④ is closed.
3. Start the engine and let it run.
4. Insert the 12-volt plug → Fig. 259 ① into one of the vehicle's 12-volt sockets → page 212.
5. Use the ON/OFF switch → Fig. 259 ② to switch on the air compressor.
6. Run the air compressor until the tyre pressure has reached 2.0 – 2.5 bar (29 – 36 psi/200 – 250 kPa) →  **Maximum running time: 8 minutes** → .
7. Switch off the air compressor.
8. If a pressure level of 2.0 – 2.5 bar (29 – 36 psi/200 – 250 kPa) cannot be achieved, unscrew the tyre filler hose from the tyre valve.
9. Drive (or reverse) the vehicle approximately 10 metres (approximately 33 ft) so that the sealing compound is evenly distributed in the tyre.
10. Screw the compressor's tyre filler hose firmly back onto the tyre valve and inflate the tyre again.
11. If the required pressure still cannot be reached, the tyre is too badly damaged. The tyre cannot be sealed with the breakdown set. Do not drive on → . Seek expert assistance.
12. Disconnect the air compressor and unscrew the tyre filler hose from the tyre valve.
13. Drive the vehicle no faster than 80 km/h (50 mph) if a tyre pressure of 2.0 – 2.5 bar (29 – 36 psi / 200 – 250 kPa) has been reached.

### Check after driving for 10 minutes

1. Park the vehicle on a firm and level surface at the next safe opportunity, e.g. a car park.

2. Reconnect the tyre filler hose → Fig. 259 ⑤ and read the tyre pressure on the tyre pressure display → Fig. 259 ③

#### 1.3 bar (19 psi/130 kPa) and lower:

1. **Do not drive on!** The tyre cannot be sealed adequately with the breakdown set → ⚠. Seek expert assistance.

#### 1.4 bar (20 psi/140 kPa) and higher:

1. Adjust the tyre pressure back to the correct value.
2. Drive carefully to the nearest suitably qualified workshop. Do not exceed a maximum speed of 80 km/h (50 mph). Volkswagen recommends using a Volkswagen dealership.
3. Have the damaged tyres replaced by a suitably qualified workshop. Volkswagen recommends using a Volkswagen dealership.

#### WARNING

The tyre filler hose and the air compressor can become hot during inflation.

- Protect your hands and skin from hot components.
- Do not place the hot tyre filler hose or the hot air compressor on any inflammable materials.
- Allow the device to cool down before stowing it.

#### WARNING

If the defective tyre cannot be sealed adequately with the breakdown set, the tyre will lose air when driving. This can lead to tyre failure, loss of control of the vehicle, accidents, serious injuries and death.

- If the tyre will not inflate to at least 2.0 bar (29 psi/200 kPa), the tyre is too damaged. The sealant is unable to seal the tyre. Do not drive on and seek expert assistance instead.
- Do not carry on driving if the tyre pressure is 1.3 bar (19 psi/130 kPa) or less after driving for 10 minutes. Seek expert assistance instead.

#### NOTICE

Switch the air compressor off after a maximum of 8 minutes to avoid overheating.

- Let the air compressor cool down for a few minutes before switching it on again. ◀

# Maintenance

## Service

### Service work and digital service schedule

#### Recording the service work performed ("digital service schedule")

The service records are stored in a central system by your suitably qualified workshop. Volkswagen recommends using a Volkswagen dealership. This transparent documentation of the service history allows the service operations performed to be reproduced at any time. Each time you have your vehicle serviced, Volkswagen recommends asking for a printed service record, which contains all service work stored in the system.

With every service, the printout of the previous service record is replaced by a current printout.

**The digital service schedule is not available in some markets. In this case, your suitably qualified workshop will inform you about the documentation process for service work. Volkswagen recommends using a Volkswagen dealership.**

#### Service work

The following information is documented in the digital service schedule by your suitably qualified workshop or Volkswagen dealership:

- When which service was carried out.
- Whether any repairs are recommended, such as replacement of the brake pads in the near future.
- Whether you had any special requests before or during the maintenance work. Your service advisor will note these on the order.
- Which components and service fluids were changed.
- When your next service is scheduled for.

The LongLife mobility guarantee is valid until the next inspection is due. Documentation takes place at every due inspection.

The type and scope of service work may differ from vehicle to vehicle. Information on specific work for your vehicle can be requested from a suitably qualified workshop. Volkswagen recommends using a Volkswagen dealership.

#### WARNING

Inadequate servicing, no servicing at all, or failure to adhere to service intervals can result in breakdowns, accidents and serious injury.

- Service work should be carried out by a suitably qualified workshop. Volkswagen recommends using a Volkswagen dealership.

#### NOTICE

Volkswagen is not responsible for any vehicle damage caused by inadequate service work or the lack of availability of parts.

 Regular servicing of your vehicle not only maintains its value, it also ensures that your vehicle remains roadworthy and in working order. You should therefore have your vehicle serviced according to the Volkswagen guidelines. <

### Fixed service or flexible service

The service events differ according to **oil change service** and **inspection**. The service interval display in the display of the instrument cluster serves as a reminder for the due date of the next service event.

Either the **fixed service interval** or **flexible service interval** will be used for the oil change service, depending on the vehicle equipment, the engine type and the operating conditions.

The engine code can be accessed via the Service menu → page 31.

#### How do I know which type of service applies to my vehicle?

Information on the service type that applies to the vehicle can be obtained from a correspondingly qualified workshop. Volkswagen recommends using a Volkswagen dealership for this purpose.

#### Point to note for the flexible service interval

With the **flexible service interval**, you need to have an oil change service carried out only if your vehicle requires one. To determine this point in time, individual operating conditions and personal driving style are taken into account. An important part of the flexible service interval is the use of LongLife engine oil instead of the conventional engine oil.

Observe and follow the information on the motor oil specification according to the VW standard → page 314, → page 315.

**If you do not wish to have the flexible service interval, you can opt for the fixed service interval instead. However, a fixed service interval can affect your service costs.** Your service advisor will be pleased to advise you.

## Service interval display

Depending on the vehicle equipment, scheduled services for your vehicle may be displayed in the service interval display in the instrument cluster display → page 33 and in the vehicle settings in the Infotainment system → page 37. This service interval display provides information on services that include an oil change or inspection. When the respective service is due, additional work that is due can also be carried out, e.g. changing brake fluid and spark plugs.

## Information on operating conditions

The service intervals and scope of service always apply to vehicles used under **normal operating conditions**.

If the vehicle is operated under **heavy-duty conditions**, some work will have to be performed before the next service is due or at shorter intervals than those specified.

### Extreme conditions include:

- Fuels containing sulphur.
- Regular short trips.
- Long periods of engine idling, e.g. taxis.
- Use in areas with high levels of dust.
- Regular trailer towing.
- Mainly stop-and-go operation, e.g. in the city.
- Driving mainly in winter conditions

### This applies particularly to the following components (depending on the vehicle equipment):

- Enhanced air filter with activated carbon
- Air Care enhanced air filter with activated carbon.
- Air filter.
- Toothed belt.
- Particulate filter.
- Engine oil.

**The service advisor at your qualified workshop will be pleased to advise you** on whether your vehicle requires more frequent work due to the conditions under which it is used.

## ⚠ WARNING

Inadequate servicing, no servicing at all, or failure to adhere to service intervals can result in breakdowns, accidents or serious injury.

- Have your service work carried out by an authorised Volkswagen dealership or workshop.

## ⚠ NOTICE

Volkswagen is not responsible for any vehicle damage caused by inadequate service work or the lack of availability of parts.

## Scope of service

The scope of service includes all **inspection work** and **maintenance work** that is required to keep your vehicle roadworthy (**depending on the operating conditions and vehicle equipment**, e.g. engine, gearbox or service fluids). A suitably qualified workshop can provide details of the work that is required for your vehicle. Volkswagen recommends using a Volkswagen dealership. Or you can find this out using the electronic repair and workshop information system **erWin** → page 362.

### Inspection work

For example, the systems listed below can be tested.

#### Electrics

- 12-volt vehicle battery: replace if necessary.
- Lighting.
- Horn.
- Headlight setting.
- Reset service interval display.

#### Engine and gearbox

- Exhaust system.
- Gearbox and final drive.
- Poly V-belt.
- Cooling system.
- Engine and components in the engine compartment.
- Engine oil level.

#### Running gear

- Swivel joints and track rods.
- Tyres.
- Brake system.
- Drive shaft boots.
- Coupling rod and stabiliser mountings.
- Breakdown set.
- Steering.
- Shock absorbers and coil springs.

#### Body

- Roof systems.
- Windscreen.

- Body corrosion.
- Windscreen wiper system and window washer system.
- Door arrester.
- Underbody.
- Water drains.

1. Perform a road test.

### Servicing work

In addition to the inspection work, further servicing work may need to be performed on your vehicle **depending on the operating conditions and vehicle equipment**, e.g. engine, gearbox or service fluids. This work is dependent on *time* and *mileage* or only *time* or *mileage*.

For example, the following service fluids and components can be changed.

- Additives.
- Enhanced air filter with activated carbon
- Brake fluid.
- Diesel filter.
- Gearbox oil filter and, if necessary, gearbox oil filter.
- Air filter.
- Engine oil and, if necessary, engine oil filter.
- Oils in the final drive and differential.
- Particulate filter.
- Toothed belt and tensioning roller.
- Spark plugs.

It is also possible to have servicing work carried out in between the displayed scheduled service events.

The scope of service is subject to change for technical reasons, e.g. continuous further development of components. Your correspondingly qualified workshop always has the latest information about any changes. Volkswagen recommends using a Volkswagen dealership.

## Vehicle care

### Notes on vehicle care

Regular and expert care helps to maintain your vehicle's condition.

The longer contamination or dirt is left on the surface of vehicle components, the more difficult it can become to clean and treat them. Extended exposure

may mean that it is no longer possible to remove contamination or dirt.

Consult a suitably qualified workshop if you have any questions about care products or if components are not listed. Volkswagen recommends using a Volkswagen dealership.

Appropriate accessories are available from a suitably qualified workshop. Volkswagen recommends using **Volkswagen Genuine Accessories**, which you can purchase from a Volkswagen dealership. Follow the application instructions on the packaging.

### WARNING

Incorrect care and cleaning of vehicle parts can impair the safety features of the vehicle and cause serious injury.

- Vehicle parts must be cleaned according to the manufacturer's instructions.
- Always use approved or recommended cleaning products.
- Do not use cleaning agents that contain solvents. Solvents can cause irreparable damage to the airbag modules.
- Protect your hands and arms against parts with sharp edges, e.g. when cleaning the insides of the wheel housings.

### WARNING

If the windscreen, door windows or rear window are dirty, iced up or affected by condensation, visibility will be reduced and the risk of accidents and severe injuries will increase. This could impair the safety equipment of the vehicle.

- Drive only when you have a clear view through all windows.
- Do not treat the windscreen with water-repellent window coating agents. In unfavourable conditions, they can cause increased dazzle.

### WARNING

Care products may be toxic and hazardous. Unsuitable care products and incorrect application of care products can cause accidents, severe injuries, burns or poisoning.

- Store care products only in the closed original container.
- Observe the manufacturer's instructions.
- Keep children away from all care products.
- Use care products only outside or in well-ventilated rooms so that you do not breathe in any toxic vapours.

- Never use turpentine, engine oil, nail varnish remover or other volatile fluids for vehicle care. These substances are toxic and highly flammable.

### ! NOTICE

Soiling with aggressive and solvent-based ingredients can cause irreparable damage to the vehicle equipment, even if left for only a short time, e.g. on seat padding or trim parts.

- Do not let contamination or dirt dry.
- Have stubborn stains removed by a suitably qualified workshop.

## Washing the vehicle

📖 Please refer to ⚠ and ⓘ at the start of the chapter on page 355.

Washing the vehicle regularly prevents effects of soiling that can damage the paint work.

Vehicles with a matt paint finish require special care due to the special paint characteristics.

To wash your vehicle correctly and properly, please observe the following information → ⓘ, → ⚠.

### ⚠ WARNING

After a car wash, the braking action may be delayed and this may extend the braking distance as the brake discs and brake pads will be wet or iced up in winter.

- Dry and de-ice the brakes by performing careful braking manoeuvres. Do not endanger any other road users when doing this.

### ! NOTICE

Improper vehicle cleaning can cause severe damage to the vehicle.

- Always follow the manufacturer's instructions.
- Do not wash the vehicle in direct sunlight.
- Never aim a water jet directly at doors or the boot lid in cold weather. The components could freeze up.

#### Removing stubborn dirt on matt paint

- Soften adhering insects or bird droppings immediately with water if possible and spray with a special cleaner for matt paints.
- Remove tar stains on the paint surface with standard commercially available tar removers.

Residue must not be removed by intensive rubbing.

- Remove tree resin and flash rust particles with a special cleaner for matt paints and cleaning clay. Move over the affected locations with the cleaning clay without exerting pressure.
- Spray grease and fingerprints with matt paint finish spray and rub off with a soft microfibre cloth.
- Rinse off petrol residue immediately with plenty of water.

#### Automatic car washes

- Never select a wash program with wax or a drying agent for **matt paint**.
- Use only textile car washes and never brush car washes for **matt paint**.
- Do not select cleaning programmes with hot wax for vehicles with decorative and protective films.
- Preferably use car washes without brushes.
- Regularly have the bottom of the vehicle thoroughly cleaned to remove residue.
- Please observe information of the car wash operator, especially where add-on parts such as spoilers are concerned → ⓘ.

- ✓ The windows must be closed and the exterior mirrors must be folded away.
- ✓ *Vehicles with steering column lock:* If the vehicle is mechanically pulled through the car wash (wash tunnel), the steering column must not unlock → page 154.
- ✓ The windscreen wipers → page 111 and the rain and light sensor → page 113 are switched off.
- ✓ The Auto Hold function → page 192 is switched off.
- ✓ If present: the roof aerial was unscrewed and removed.

### ! NOTICE

Car washes that scan the contours mechanically may damage the vehicle, e.g. spoiler.

#### High-pressure cleaner

- Never use rotary nozzles. Observe the manufacturer's instructions.
- Use water up to a maximum temperature of +60°C (+140°F) only.
- Move the jet of water uniformly so that the nozzle is at least 50 cm (20 inches) away from all the vehicle components.

- Do not point the water jet at the same location for too long.
- Aim the water jet indirectly at sensitive vehicle components if possible, e.g. rubber seals, side windows, gloss strips, tyres, sensors, camera lenses, decorative and protective film.
- Never clean windows that are iced up or covered in snow with a high-pressure cleaner.

### Hand wash

Isolated soiling on the paint can be removed with cleaning clay.

1. Clean the vehicle with plenty of water to remove dust and coarse soiling.
2. In the case of **matt paint**, remove insects, grease stains and fingerprints with a special cleaner for matt paints. Apply the product with a microfibre cloth with gentle pressure.
3. Clean with a soft sponge, a wash mitt or a brush applying only light pressure. Start with the roof and work from the top to the bottom. Use a cleaning shampoo only for very stubborn dirt.  
In the case of **matt paint**, clean from top to bottom with a neutral cleaning shampoo and a microfibre cloth. Thoroughly wash out the microfibre cloth at short intervals.
4. Clean wheels and side members with a clean sponge.
5. Rinse off with plenty of water.
6. Allow the vehicle to dry in the air. Remove water residue with a chamois leather.

### ! NOTICE

The matt paint effect can be destroyed if the vehicle is not washed correctly.

- Never use wash programs with wax preservation.
- As a general rule, only cleaning agents that do not contain solid matter or abrasives, such as cleaning shampoos or insect remover, must be used.
- Do not use insect sponges, rough kitchen sponges or similar. These could damage the surface.

### ! NOTICE

The drainage channels for the plenum chamber may become blocked by leaves and dirt. Water that fails to drain away can enter the vehicle interior. Water that has entered the plenum chamber via a manual process (e.g. from a high-pressure cleaner) can cause considerable damage to the vehicle.

- Remove leaves and other loose objects with a vacuum cleaner or by hand.

- Have the area under the perforated cover cleaned by a qualified workshop.

 Wash the vehicle in dedicated cleaning areas only. This prevents any waste water contaminated by oil from entering the sewage system. <

## Caring for and cleaning the vehicle exterior

 Please refer to  and  at the start of the chapter on page 355.

The following overview contains recommendations for cleaning and care of individual vehicle components.

### Windows, glass surfaces

- Remove wax residue, e.g. from care products, using a suitable glass cleaner or with the Volkswagen Genuine cleaning cloth.
- Remove snow with a hand brush.
- Remove ice with a plastic scraper. Move the scraper in one direction only.
- Thaw ice with a suitable de-icer or with Volkswagen Genuine de-icer.
- Clean the wiper blades or replace them as required.

### Paint

Always treat surfaces with care so as not to remove the paint.

- Use a clean, soft cloth and a mild soap solution consisting of a maximum of two tablespoons of neutral soap diluted in one litre of water or cleaning clay to remove any light dirt immediately, e.g. deposits, insect residue, or cosmetics.
- Remove overflowing fuel or service fluids immediately.
- Moisten flash rust deposits with a soap solution. Then remove any deposits with cleaning clay.
- Have corrosion removed by a correspondingly qualified workshop. Volkswagen recommends using a Volkswagen dealership.
- In the event of paint damage, go to a correspondingly qualified workshop and have the paint damage repaired. Volkswagen recommends using a Volkswagen dealership.

Waxing protects the paintwork. At the latest when water no longer clearly forms small drops and runs off the paintwork when the vehicle is *clean*, the ve-

hicle should be protected again using a preservative wax.

- In the case of **matt paint**, use a soft sponge to apply a special wax for matt paints to the cleaned vehicle. Remove excess wax with a microfibre cloth.
- Even if a preservative wax is used regularly in the car wash, Volkswagen recommends protecting the paint with suitable hard wax or with Volkswagen Genuine hard wax at least twice a year.
- Polishing is only necessary if the paint has lost its shine, and the gloss cannot be brought back by applying wax.

**Never polish matt-painted surfaces.** The surface will be irreparably damaged by polishing the paint.

### Plenum chamber, engine compartment



**Fig. 260** Between the engine compartment and the windscreen: plenum chamber (illustration).

- Remove leaves and other loose objects with a vacuum cleaner or by hand → Fig. 260 , → ⓘ.
- Always have cleaning of the engine compartment performed by a correspondingly qualified workshop → ⚠. Volkswagen recommends using a Volkswagen dealership.

Water that has entered the plenum chamber via a manual process (e.g. from a high-pressure cleaner) can cause considerable damage to the vehicle.

#### ⓘ NOTICE

The drainage channels for the plenum chamber may become blocked by leaves and dirt. Water that fails to drain away can enter the vehicle interior.

- Have the area under the perforated cover cleaned regularly by a correspondingly qualified workshop. Volkswagen recommends using a Volkswagen dealership.

### Sensors, camera lenses



**Fig. 261** At the rear of the vehicle: rear view camera system on the handle button (illustration).

- Clean the area in front of the sensors or camera with a soft cloth and solvent-free cleaning agent.
- Clean sensitive surfaces on the rain and light sensor and the camera window on the windscreen in the same way as **windows and glass surfaces** (depending on vehicle equipment).
- Remove snow with a hand brush.
- Never use warm or hot water.
- Thaw ice with a suitable de-icer or with Volkswagen Genuine de-icer.

### Decorative films, protective films

- Remove soiling the same way as for **paint**. Use a suitable plastic cleaner or Volkswagen Genuine plastic cleaner for matt decorative films.
- Treat the vehicle with liquid hard wax every three months after washing and removing dust. Only use clean, soft microfibre cloths to apply the wax. **Do not use hot wax**, even in car washes.
- Stubborn dirt: remove carefully using white spirits, and then rinse with warm water.

ⓘ The durability and colour of decorative and protective films may be affected by environmental influences, such as sunlight, moisture, polluted air, stone impacts, etc. Decorative films may show signs of wear and ageing after around one to three years, and protective films after two to three years. In very hot climates, decorative films may become faded within one year and protective films within two years.

### Trim parts made of chrome-plated plastic, aluminium or stainless steel

- Clean the surface with a suitable chrome and aluminium care product or with the Volkswagen Genuine chrome and aluminium care product.



- Chrome-plated trim parts can be preserved with a suitable hard wax or Volkswagen Genuine hard wax.

#### Headlights, tail light clusters

- Remove soiling using a soft sponge soaked with a mild soap solution consisting of a maximum of two tablespoons of neutral soap diluted in one litre of water. Do not use any cleaning agents that contain alcohol or solvents.
- Remove stubborn dirt with a suitable chrome and aluminium care product or with the Volkswagen Genuine chrome and aluminium care product.

#### Wheels

- Remove dirt and gritting salt deposits with plenty of water.
- Clean dirty alloy wheels with a suitable wheel rim cleaner or with Volkswagen Genuine wheel rim cleaner. Volkswagen recommends treating the wheel rims with a suitable hard wax or with Volkswagen Genuine hard wax every three months.
- Repair any damage to the protective paint coating immediately with a touch-up pen. Go to a correspondingly qualified workshop if necessary. Volkswagen recommends using a Volkswagen dealership.
- Remove brake dust with a suitable wheel rim cleaner or with Volkswagen Genuine wheel rim cleaner.

#### Door lock cylinders

1. Thaw door lock cylinders with a suitable door lock de-icer or with Volkswagen Genuine de-icer.  
Do not use door lock de-icer containing degreasing substances.

#### WARNING

The engine compartment of the vehicle is a hazardous area. All work in the engine compartment carries the risk of injury, scalding, accidents and fire.



- Before carrying out any work in the engine compartment, always observe the required procedures and safety precautions → page 310, *Safety notes for working in the engine compartment*.
- Have the work performed by a suitably qualified workshop. Volkswagen recommends using a Volkswagen dealership.

#### NOTICE

Incorrect cleaning and care may cause vehicle damage.

- Always follow the manufacturer's instructions.
- Do not use excessively hard, abrasive cleaning tools.

#### Vehicle interior cleaning and care

 Please refer to  and  at the start of the chapter on page 355.

The following overview contains recommendations for cleaning and care of individual vehicle components.

#### NOTICE

Incorrect cleaning and care may cause vehicle damage.

- Do not use a steam cleaner, brushes or hard sponges etc. under any circumstances.
- Have stubborn stains removed by a qualified workshop.

#### Windows

- Clean windows with a glass cleaner.
- Wipe the windows dry with a clean chamois leather or a lint-free cloth.

#### Textiles, microfibre cloth and leatherette

- Regularly remove dirt particles adhering to surfaces with a vacuum cleaner so that the material is not permanently damaged by abrasion.
- Remove dirt with a suitable interior cleaner or with Volkswagen Genuine interior cleaner.
- In the case of grease-based soiling such as oil, use a suitable interior cleaner or Volkswagen Genuine interior cleaner. Dab off dissolved grease and colour particles with an absorbent cloth. Then treat with water if necessary.
- In the case of soiling caused by ballpoint pens or nail varnish, for example, use a suitable interior cleaner or Volkswagen Genuine interior cleaner. If necessary, treat subsequently with a mild soap solution consisting of a maximum of two tablespoons of neutral soap diluted in one litre of water.
- Never use leather care agents, solvents, wax polish, shoe cream, stain removers or similar.
- Never use high-pressure cleaners, steam cleaners and coolant spray.

### Natural leather

- Remove fresh contamination using a cotton cloth with a mild soap solution consisting of a maximum of two tablespoons of neutral soap diluted in one litre of water. Do not allow fluids to seep into the seams.
- In the case of soiling caused by ballpoint pens or nail varnish, for example, use a suitable leather cleaner or Volkswagen Genuine leather cleaner.
- Treat dried-in stains with a suitable leather cleaner or Volkswagen Genuine leather cleaner.
- For grease-based soiling such as oil, remove fresh stains with an absorbent cloth.
- Apply leather care agent for seating furniture regularly and each time after the leather is cleaned. If the vehicle is parked outdoors for long periods, you should cover the leather to protect it from direct sunlight.

Never treat leather with solvents, wax polish, shoe cream, stain removers or similar.

### Plastic parts

- Clean with a soft, moist cloth.
- If stubborn soiling cannot be removed with mild soap solution consisting of a maximum of two tablespoons of neutral soap diluted in one litre of water, use a solvent-free plastic cleaning agent or Volkswagen Genuine plastic cleaner if necessary.

### Trim parts, trim strips made of chrome, aluminium or stainless steel

- Clean with a clean, soft cloth and mild soap solution consisting of a maximum of two tablespoons of neutral soap diluted in one litre of water in a dust-free environment.
- Treat anodised surfaces with a suitable chrome and aluminium care product or with the Volkswagen Genuine chrome and aluminium care product.

### Control elements

1. Remove coarse dirt and other dirt that is difficult to reach using a soft brush.
2. Use a clean, soft cloth with some mild soap solution consisting of a maximum of two tablespoons of neutral soap diluted in one litre of water. Do not allow liquids to enter the controls.

### Displays and screens

Do not clean the instrument cluster display and Infotainment system screen with a dry cloth.

1. Switch off the Infotainment system temporarily before cleaning.

2. Use a suitable cleaning cloth or Volkswagen Genuine cleaning cloth with a little water, a suitable glass cleaner or LCD cleaner.

### NOTICE

The head-up display may detach from the guide rail as a result of applying excessive pressure, e.g. during cleaning.

- Do not apply excessive pressure when cleaning the head-up display.

### NOTICE

Clean the head-up display only with mild detergents and a soft, clean cloth.

### Rubber seals

- Clean with a soft and lint-free cloth as well as plenty of water.
- Regularly treat with a suitable rubber care product or the Volkswagen Genuine rubber care product.

### Seat belts

1. Carefully pull the seat belt right out and leave it out.
2. Remove coarse dirt with a soft brush.
3. If necessary, clean the seat belt with a mild soap solution consisting of a maximum of two tablespoons of neutral soap diluted in one litre of water.
4. Leave the belt fabric to dry completely and then allow it to roll up.

### WARNING

Failure to clean the parts properly can cause damage to the seat belts, the fastenings and the belt retractor.

- Never try to modify or remove the seat belts for cleaning.
- Never clean the seat belts and their components with chemical agents.
- Do not use any caustic liquids, solvents or sharp objects.
- Protect the belt buckles against the ingress of liquids and foreign bodies.
- Let the cleaned seat belt to dry completely before allowing it to retract.

### Wooden trims

Clean with a soft cloth and some mild soap solution consisting of a maximum of two tablespoons of neutral soap diluted in one litre of water.

## Cleaning seat covers

If clothing that is not sufficiently colour-fast, e.g. denim which leaves stains on the seat cushion, then this is not due to the cover fabric. The seat padding may contain components for the airbag system and electrical connections. Seat padding that is damaged, incorrectly cleaned or treated, or that becomes wet, may cause damage to the vehicle electrical system or trigger a fault in the airbag system → ⚠️

Depending on the vehicle equipment, seat cushions with seat heating have electrical components and connectors that may be damaged in the event of incorrect cleaning or treatment. This can also result in damage to other parts of the vehicle electrics.

- Never use high-pressure cleaners, steam cleaners and coolant spray.
- Never soak seat covers.
- Never switch on the seat heating to dry the seats.
- Do not use washing paste or fine detergent solutions.
- If in doubt, go to a correspondingly qualified workshop. Volkswagen recommends using a Volkswagen dealership.

### ⚠️ WARNING

Incorrect care and cleaning of vehicle parts can impair the safety features of the vehicle and cause serious injury.

- Vehicle parts must be cleaned according to the manufacturer's instructions.

 The signs of wear and soiling visible due to normal use are naturally more easily visible in the case of light-coloured materials in the vehicle interior. These signs of use cannot be prevented and also represent unavoidable ageing due to normal use. Please observe the corresponding care instructions. <

## Accessories, modifications, repairs and renewal of parts

### Accessories and replacement parts

Seek advice from a suitably qualified workshop before purchasing accessories, replacement parts or service fluids, for example if the vehicle is to be retrofitted with accessories or if parts have to be renewed. Qualified workshops can provide information on legal requirements and also recommend accesso-

ries, replacement parts and service fluids. Volkswagen recommends using a Volkswagen dealership.

Volkswagen recommends using Volkswagen Genuine Parts and Volkswagen Genuine Accessories, which you can purchase from a Volkswagen dealership. These parts and accessories have been specially tested by Volkswagen for suitability, reliability and safety. A qualified workshop is also qualified to install them correctly. Volkswagen recommends using a Volkswagen dealership.

Although the market is constantly scrutinised, Volkswagen cannot assume responsibility for the reliability, safety and suitability of products Volkswagen has not approved. Volkswagen can therefore assume no responsibility for these parts, even if they have been approved by an official testing agency or are covered by an official approval certificate.

Any retrofitted equipment which has a direct effect on the control of the vehicle must be approved by Volkswagen for use in your vehicle and bear the e mark (approval symbol of the European Union). These devices include cruise control systems or electronically controlled damping systems, for example.

Any additional electrical components fitted that do not serve to control the vehicle itself must bear the CE mark (manufacturer declaration of conformity in the European Union). Such devices include refrigerator boxes, computers and ventilator fans.

### ⚠️ WARNING

Unsuitable accessories and spare parts can cause vehicle damage, malfunctions, accidents and serious injuries.

- Volkswagen recommends using Volkswagen Genuine Parts® or Volkswagen Genuine Accessories, which you can purchase from a Volkswagen dealership.
- Never fit parts to your vehicle that differ in their design or characteristics from the factory-fitted parts.
- Use only wheel rim/tyre combinations that have been approved by Volkswagen for your vehicle type.

### ⚠️ WARNING

Objects in the deployment zone of the airbags can cause serious or fatal injuries if the airbags are deployed.

- Never secure or position objects in the deployment zones of the airbags.

## ! NOTICE

Unsuitable accessories and replacement parts can damage the vehicle and cause malfunctions.

Retrofitting an engine preheating system can damage certain engines.

- Discuss the retrofitting of an engine preheating system with a qualified workshop to find out which engines are suitable. Volkswagen recommends using a Volkswagen dealership.

## Repairs and technical modifications

**Repairs and technical modifications must always be carried out according to Volkswagen specifications** → ⚠.

Unauthorised modifications to the electronic components or software in the vehicle may cause faults. As the electronic components are linked together in networks, these faults may indirectly affect the working of other systems. This can seriously impair vehicle safety, lead to excessive wear of components and also invalidate the type approval for the vehicle.

The Volkswagen dealership cannot be held liable for any damage caused by technical modifications and/or work performed incorrectly.

The Volkswagen dealership is not responsible for damage caused by technical modifications and/or work performed incorrectly. Such damage is not covered by the Volkswagen guarantee.

Have all repairs and technical modifications carried out by a correspondingly qualified workshop. Volkswagen recommends using a Volkswagen dealership that supplies Volkswagen Genuine Parts®.

### Volkswagen repair information

Volkswagen Service information and official Volkswagen repair information can be obtained for a fee.

### Customers in Europe, Asia, Australia, Africa, Central and South America:

Please contact a suitably qualified workshop. Volkswagen recommends using a Volkswagen dealership. Or register on the internet portal **erWin** (electronic repair and workshop information):

<https://erwin.volkswagen.de>

### Customers in North America and Canada:

To order printed service information please contact: Volkswagen Technical Literature Ordering Center  
[literature.vw.com](http://literature.vw.com)

You can also register online in the **erWin** internet portal:

<https://erwin.vw.com>

### Diagnostic interface (OBD)

There is a diagnostic interface in the vehicle interior for reading the event memories (OBD). Event memories document any errors that have occurred and any deviations from the nominal values in the electronic control units → ⚠.

The diagnostic interface (OBD) is located in the footwell on the driver side underneath the dash panel, or behind a cover next to the bonnet release lever.

The event memory should only be read and reset by a suitably qualified workshop. Additional information on the stored data is available from suitably qualified workshops. Volkswagen recommends using a Volkswagen dealership.

After a fault has been rectified, the information in the event memory relating to the fault is deleted. Other memory content is overwritten on an ongoing basis.

### Vehicles with special auxiliary equipment or body parts

Auxiliary equipment and second stage manufacturers must ensure that the equipment and bodies (conversions) adhere to the stipulated environmental laws and regulations, particularly the EU directive 2000/53/EC concerning end-of-life vehicles and EU directive 2003/11/EC concerning the restriction on the marketing and use of certain dangerous substances and preparations.

The vehicle owner must keep all assembly documentation for these conversions and pass it on to the scrapping company upon vehicle handover if the vehicle is scrapped. This is intended to facilitate environmentally responsible disposal for all vehicles, including refitted vehicles.

### Windscreen repairs

To function properly, some items of equipment require an electrical or electronic module, which is located on the inside of the windscreen near the interior mirror. If the windscreen has been damaged in the viewing field of the electrical or electronic module, e.g. by stone impact, the windscreen must be replaced. Repairing the crack can lead to malfunction or functional faults in the equipment.

After changing the windscreen, the camera and sensors must be adjusted and calibrated by a correspondingly qualified workshop. Volkswagen recommends using a Volkswagen dealership.

### Impairment or damage to sensors and cameras

Incorrectly performed repairs, structural changes to the vehicle, e.g. lowering the suspension, retrofitted add-on parts or changes to the trim can lead to sensors and cameras being displaced or damaged. This can also be caused by collisions when parking, or also even by minor damage such as stone impacts on the windscreen.

The area in front of and around the sensors and cameras must not be covered by stickers, additional headlights, trim frames for number plates or similar. Observe the position of sensors and cameras on the vehicle overviews.

Failure to observe this may impair important functions of driver assist systems and damage the vehicle.

Repairs and structural modifications should be carried out by a correspondingly qualified workshop. Volkswagen recommends using a Volkswagen dealership.

Further information:

- Repainting and paint touch-ups in the area around the sensors may impair the function of the system in question.
- On some vehicle models, the Volkswagen badge can impair the view of the radar sensor in the front area. You should therefore operate the vehicle only with the original Volkswagen badge or a badge approved by Volkswagen.

### Engine and transmission guard

An engine and transmission guard can reduce the risk of damage to the vehicle's underbody and sump, for example when driving over kerbs, drive entrances or unsurfaced roads.

Have retrofitting carried out by a correspondingly qualified workshop. Volkswagen recommends using a Volkswagen dealership.

An engine and transmission guard may not be available in all countries.

### WARNING

Incorrect repairs and modifications to the vehicle can impair the effectiveness of the driver assistance systems and the airbags when they trigger. This can cause malfunctions, accidents and fatal injuries.

- Have repairs and modifications to your vehicle carried out only by a correspondingly qualified workshop. Volkswagen recommends using a Volkswagen dealership.

### WARNING

Incorrectly performed repairs and modifications can damage the vehicle and cause accidents and serious injuries.

- Volkswagen recommends using Volkswagen Genuine Parts and Volkswagen Genuine Accessories, which you can purchase from a Volkswagen dealership. These parts and accessories have been specially tested by Volkswagen for suitability, reliability and safety.
- Have repairs and modifications to your vehicle carried out only by a correspondingly qualified workshop. Qualified workshops have the necessary tools, diagnostic equipment, repair information and qualified personnel. Volkswagen recommends using a Volkswagen dealership.
- Never fit parts to your vehicle that differ in their design or characteristics from the factory-fitted parts.
- Use only wheel rim/tyre combinations that have been approved by Volkswagen for your vehicle type.

### WARNING

Incorrect use of the diagnostic interface can cause malfunctions, which can result in accidents and serious injuries.

- Never read the event memory yourself using the diagnostic interface.
- Never upload data to the vehicle yourself using the diagnostic interface.
- The event memory should be read only by a suitably qualified workshop using the diagnostic interface. Volkswagen recommends using a Volkswagen dealership.

## Repairs and faults in the airbag system

Repairs and technical modifications must always be carried out according to Volkswagen specifications

→ 

Modifications and repairs to the front bumper, the doors, the front seats, the roof or the bodywork should only be carried out by a suitably qualified workshop. Volkswagen recommends using a Volkswagen dealership. System components and airbag system sensors might be fitted on these vehicle components.

If you work on the airbag system or remove and install parts of the system when performing other re-

pair work, parts of the airbag system may be damaged. The consequence may be that, in the event of an accident, the airbag inflates incorrectly or does not inflate at all.

Regulations must be observed to ensure that the effectiveness of the airbags is not reduced and that removed parts do not cause any injuries or environmental pollution. These requirements are known to the correspondingly qualified workshops. Volkswagen recommends using a Volkswagen dealership.

Any modifications to the vehicle's suspension could prevent the airbag system from working properly during a collision. For example, using wheel rim/tyre combinations that have not been approved by Volkswagen, lowering the vehicle or making modifications to the suspension rate including work on the springs, struts and shock absorbers etc., could change the forces that are measured by the airbag sensors and sent to the electronic control unit. Some changes to the suspension could cause the forces measured by the sensors to increase, for example. This can lead to the airbag system being triggered in collision scenarios where it normally would not be triggered if modifications to the suspension had not been made. Other modifications can cause the forces measured by the sensors to decrease, therefore preventing the airbag system from being triggered when it should have been.

#### WARNING

Incorrect repairs and modifications can cause function problems and damage to the vehicle and impair the effectiveness of the airbag system. This can result in accidents and serious or even fatal injuries.

- Have repairs and modifications to your vehicle carried out only by a correspondingly qualified workshop. Volkswagen recommends using a Volkswagen dealership.
- Airbag modules cannot be repaired. They must be replaced.
- Never install recycled airbag components or components that have been taken from end-of-life vehicles in your vehicle.

#### WARNING

Modifications to the vehicle's suspension, including the use of unsuitable tyre/rim combinations, can cause the airbag system to work differently and increase the risk of serious or fatal injuries in the event of an accident.

- Never install components in the suspension system which do not have the same characteristics as the original factory-fitted components.

- Never use wheel rim/tyre combinations that have not been approved by Volkswagen.

## Mobile communication in the vehicle

### Electromagnetic radiation

If a mobile telephone or radio device is used without being connected to the external aerial, the electromagnetic radiation will not be optimally directed to the outside of the vehicle. Increased levels of radiation in the vehicle interior may occur in areas with poor signal in particular, for instance in rural areas. This could constitute a health hazard → .

Depending on the vehicle's equipment level, a suitable mobile phone interface can be used to connect the mobile telephone to the external aerial. The connection quality is improved and the range is increased.

### Using the telephone

Many countries require a hands-free system to be used when using a telephone inside the vehicle, e.g. via a Bluetooth<sup>®</sup> connection. Before use, secure the mobile telephone to a suitable bracket →  or stow it in a storage compartment so that it cannot slip around, e.g. in the centre console.

### Two-way radios

Observe legal requirements and the manufacturer's operating instructions for operating two-way radios. The retrofitting of two-way radios requires authorisation.

Ask a qualified workshop for further information on installation of a two-way radio. Volkswagen recommends using a Volkswagen dealership.

#### WARNING

Mobile telephones which are loosely placed in the vehicle or not properly secured could be flung through the interior and cause injuries during a sudden driving or braking manoeuvre, or in the event of an accident.

- Secure a mobile telephone and accessories outside the deployment zone of the airbags, or stow them safely.

#### WARNING

If mobile telephones or two-way radios that are not connected to an external aerial are used, electromagnetic radiation in the vehicle could exceed limit values and thus be a health hazard for drivers and other vehicle occupants. This also applies to

external aerials which have not been correctly installed.

- Keep a distance of at least 20 cm (8 inches) between a device's aerial and an active medical implant, e.g. a pacemaker.
- Do not carry device which is operationally ready close to or directly above an active medical implant, e.g. in a breast pocket.
- Switch off the device immediately if you suspect it may be interfering with an active medical implant or any other medical device.

## Customer information

### Warranty

#### Volkswagen dealership warranty

Volkswagen dealerships guarantee that the vehicles they sell are free from defects. The dealerships are also responsible for handling warranty claims.

Please refer to your sales contract or contact your Volkswagen dealership for details of the warranty and guarantee conditions.

#### Warranty for the paintwork and body

Volkswagen dealerships provide a warranty on the paintwork and body of all vehicles purchased from them.

In addition to the warranty conditions for factory-new Volkswagen vehicles (as detailed in the purchase contract), the Volkswagen dealer guarantees that the body of any vehicles it sells will not be affected by paint imperfections or corrosion perforation for a specified period:

- A three-year warranty on paint defects.
- A twelve-year corrosion perforation warranty. Here, corrosion perforation refers to rust forming on the inside (cavity) of the body and causing holes in the sheet metal.

If such damage occurs nevertheless, it will be repaired free of charge for parts and labour by any Volkswagen dealership.

*The warranty does not cover the following:*

- Damage caused by external influence or insufficient care.
- Imperfections on the body or paintwork which are not repaired promptly according to manufacturer specifications.
- Corrosion perforation that is directly related to body repairs not being carried out according to manufacturer specifications.

If the body is repaired or painted, your Volkswagen dealership will confirm your warranty against corrosion perforation for the repaired area.

## LongLife mobility guarantee

In many European markets, Volkswagen dealerships offer a comprehensive LongLife mobility guarantee for new vehicles. It applies from vehicle delivery until the first scheduled inspection.

If you purchase your new vehicle directly from Volkswagen, Volkswagen will issue the LongLife mobility guarantee from the time of delivery until the first due inspection.

Your Volkswagen service partner will extend the LongLife mobility guarantee until the following inspection if the due inspection is carried out at that workshop. The service costs include the entire guarantee package.

Please ask your Volkswagen dealership for details of services, conditions and time limits relating to the LongLife mobility guarantee.



## Data storage and services

Valid in EU countries where the General Data Protection Regulation of the European Union is effective:

### Data processing in the vehicle

Your vehicle is fitted with electronic control units. Control units process data that they receive from vehicle sensors, generate themselves or exchange with each other, for example. Some control units are required for the safe functioning of your vehicle, others support you when driving (driver assist systems), others enable convenience or additional functions of the Infotainment system.

### Personal reference

Each vehicle is given a unique vehicle identification number. In Germany, for example, this vehicle identification number can be traced back to the current and former owners of the vehicle using information provided by the Federal Motor Transport Authority (Kraftfahrtbundesamt). There are also other ways of tracing the vehicle to the owner or driver, via data collected for the vehicle e.g. the registration number.

The data generated or processed by control units may therefore be personal data or under certain conditions is personal data. Depending on the vehicle data available, it may be possible to draw conclusions, e.g. about your driving behaviour, your location or your route or your usage behaviour.

### Your rights regarding data protection

In accordance with applicable data protection law, you have certain rights vis-à-vis Volkswagen when your personal data is processed.

Accordingly, you are entitled to receive comprehensive information free of charge from Volkswagen and third parties, e.g. breakdown services or workshops used and providers of online services in the vehicle if they have stored your personal data. You are entitled to request information concerning what personal data and for what purpose it is stored as well as where the data originates from. Your right to information also includes the transfer of data to other bodies.

Further information on your legal rights, e.g. your right to have your data deleted or corrected, can be found in the applicable data protection information on the Volkswagen website including the contact details and a reference to the data protection officer.

Data that is only stored locally in the vehicle can be read out for a fee with expert assistance, e.g. in a workshop.

### Legal requirements for the disclosure of data

If legal requirements exist, Volkswagen is obliged to disclose data stored at Volkswagen to the extent required to government agencies in individual cases, e.g. as part of a police investigation of a criminal offence.

Within the framework of applicable law, government agencies are also authorised to read data from vehicles themselves in individual cases. In the event of an accident, information can be read from the airbag control unit to help clarify the situation.

### Operating data in the vehicle

Control units process data to operate the vehicle.

These include, for example:

- Vehicle status information, e.g. speed, deceleration, lateral acceleration, number of wheel revolutions and display of closed seat belts.
- Ambient conditions, e.g. temperature, rain and light sensor, adaptive cruise control.

As a rule, this data is volatile and is not stored beyond the operating time and is only processed in the vehicle itself. Control units often contain data storage devices. These are used to document information regarding the vehicle status, component load levels, maintenance requirements, technical events and faults on a temporary or permanent basis.



Depending on the technical equipment, the following data is stored:

- Operating states of system components, e.g. filling levels, tyre pressure, status of the vehicle battery.
- Faults or malfunctions in important system components, e.g. lights, brakes.
- System reactions to specific driving situations, e.g. triggering of an airbag, intervention of the stability control systems.
- Information on events which damaged the vehicle.

In special cases, e.g. when the vehicle has detected a malfunction, it may be necessary to store data that would normally only be volatile.

If you make use of services, e.g. repairs or maintenance work, the stored operating data can, if necessary, be read and used together with the vehicle identification number. The data can be read from the vehicle by employees of the service network, e.g. workshops, or third parties, e.g. breakdown services. The same applies to warranty cases and quality assurance measures.

The data is read via the vehicle's OBD connection ("on-board diagnosis") that is required by law → page 362, *Repairs and technical modifications*. The operating data that is read documents the technical status of the vehicle or individual components thereof and provides support with fault diagnosis, compliance with warranty obligations and quality improvement. This data, in particular information on component load-levels, technical events, operating errors and other faults, is transmitted to Volkswagen together with the vehicle identification number if necessary. Furthermore, the manufacturer is liable for the product. Here too, Volkswagen uses operating data from vehicles for product recalls, for example. This data can also be used to check the customer's warranty and guarantee claims.

Fault memories in the vehicle can be reset by an authorised workshop or at your request as part of repair or service work.

### Reprogramming control units

All data for the control of components is stored in the control units. Some convenience functions, such as convenience turn signal, single door unlocking and displays, can be reprogrammed using special workshop equipment. If the convenience functions are reprogrammed, the specifications and descriptions in this owner's manual will no longer match the original functions. Have the reprogramming entered into the digital service schedule by a suitably qualified workshop. Volkswagen recommends using a Volkswagen dealership.

Suitably qualified workshops are informed about this type of reprogramming. Volkswagen recommends using a Volkswagen dealership.

### Convenience functions

You can store convenience settings (personalisation) in the vehicle and change or reset them at any time.

Depending on the equipment in the vehicle, this includes, for example:

- Settings of the seat and steering wheel positions.
- Running gear and air conditioning settings.
- Personalised settings such as mirror adjustment or background lighting.

### Infotainment system

Depending on the equipment installed, you may be able to store your own data in the vehicle's Infotainment system.

Depending on the equipment in the vehicle, this includes, for example:

- Media files for playback of music, films or photos in an Infotainment system.
- Address book data for use with a hands-free system or navigation system.
- Navigation destinations entered.
- Data on the use of online services.

This data can be stored locally in the vehicle or located on a device that you have connected to the vehicle, e.g. mobile telephone, USB stick or MP3 player. If this data is stored in the vehicle, you can delete it at any time.

This data is transmitted to third parties only at your request, in particular in relation to the use of online services and in accordance with your personal settings.

### Integration of mobile telephones

If your vehicle contains the necessary equipment, you can connect your mobile telephone or any other mobile end device to your vehicle so that you can control this device via the controls integrated in the vehicle when the corresponding functions are available. For example, images and sounds from the mobile telephone can be output through the Infotainment system. At the same time, certain information is sent to your mobile telephone. This includes location data and further general vehicle information, depending on the type of integration. For more details, refer to the information about display of apps in the Infotainment system.

This enables you to use selected mobile telephone apps in the vehicle, e.g. navigation or music player. The mobile telephone and vehicle do not interact in any other ways than those described here; in partic-

ular the device does not actively access vehicle data. The type of further data processing depends on the app provider. The settings that you can adjust here depend on the app you are using and the operating system on your mobile telephone.

### Online services

If your vehicle is equipped with a connection to a mobile network, your vehicle will be able to exchange data with other systems. The vehicle can be connected to a mobile network using a transmitter and receiver unit in the vehicle or using your own mobile end devices, e.g. mobile telephones. This mobile network connection enables you to use online functions. This includes online services and apps provided by Volkswagen or other third-party providers.

### Manufacturer services

In the case of Volkswagen online services, Volkswagen describes the respective functions in a suitable place, e.g. in a separate service description or on an Internet page, and the associated privacy information is provided. Personal data may be required in order to provide online services. For this, data is exchanged over a secure connection, e.g. using the designated IT systems of the manufacturer. Any collection, processing and use of personal data that goes beyond the provision of the service takes place exclusively according to legal regulations, contractual agreements or the necessary permission.

You can activate and deactivate the services and functions, some of which are subject to a fee and in some cases also disable the vehicle's entire data connection. This does not apply to any functions and services required by law, e.g. emergency call systems.

### Third-party services

If you are able to use online services provided by a party other than the manufacturer, these services are the sole responsibility of the provider in question and are subject to this provider's data protection policy and terms and conditions of use. Volkswagen has no influence over the content exchanged as part of these services.

Please refer to the provider in question for information about the type, scope and purpose of the collection and use of personal data related to third-party services.

## Event data recorder

This vehicle is equipped with an event data recorder. The event data recorder's main job is to record data

in accidents or situations similar to an accident, e.g. when an airbag is triggered or when the vehicle collides with an obstacle on the road, which then supports analysis of how a vehicle system behaved. The event data recorder is intended to record data relating to driving dynamics and the restraint system for a short period of 30 seconds or less. The event data recorder of this vehicle is intended to record the following data, amongst other things:

- How various systems in your vehicle have functioned.
- Whether the driver and front passenger seat belts were fastened/secured.
- The extent to which the driver pressed the brake or accelerator pedal (if at all).
- How fast the vehicle was travelling.

This data helps to obtain a better understanding of the circumstances in the situations where accidents and injuries have occurred.

Data from driver assist systems are also recorded. In addition to information about whether the systems were switched on or off, available only to a restricted extent or inactive, it is also possible to determine whether these functions steered, accelerated or braked the vehicle in the above-described situations. Depending on the vehicle equipment, these systems include the following:

- Adaptive Cruise Control.
- lane keeping system.
- Park Assist.
- emergency braking function.

EDR data is recorded by your vehicle only if an unusual situation similar to an accident occurs. No data is recorded by the event data recorder under normal driving conditions. In addition, no personal data, e.g. name, gender, age or accident location, is recorded. However, third parties such as law enforcement agencies can use appropriate means to link the content of the event data recorder with other sources of data and thus establish a reference to persons as part of an accident investigation.

Special equipment and access to the vehicle or event data recorder are necessary in order to read data from the event data recorder. In addition to the vehicle manufacturer, third parties such as law enforcement agencies that have the corresponding equipment can read out the information if they have access to the vehicle or event data recorder.

Volkswagen will not access, read or process data from the event data recorder unless the vehicle owner (or lessee in the case of leasing) grants their permission. Exceptions to this are contractual or legal provisions.

Due to its legal product monitoring obligations, Volkswagen is entitled to use the data for field monitoring and also for research purposes and quality improvements. For research purposes, Volkswagen makes the data available to third parties in anonymous form, in other words without any reference to the individual vehicle, vehicle owner or lessee.

## Information stickers and plates

Stickers and plates showing important information for vehicle operation are factory-fitted in the engine compartment and on certain vehicle parts.

- Never remove stickers and plates or render them illegible.
- If vehicle parts bearing stickers or plates are removed from the vehicle, replacement stickers or plates with the same information must be applied properly to the new parts by a correspondingly qualified workshop. Volkswagen recommends using a Volkswagen dealership.

### Safety certificate

There is a safety certificate on the door pillar of the driver door which states that all necessary safety standards and specifications from the transport safety authorities of the particular country were met at the time of production. The month and year of production and the vehicle identification number may also be listed. Observe notes in the owner's manual.

#### **WARNING**

Handling the vehicle incorrectly will increase the risk of accident and injuries.

- Observe legal requirements.
- Observe the owner's manual.

#### **NOTICE**

Handling the vehicle incorrectly could lead to the vehicle becoming damaged.

- Observe legal requirements.
- Carry out servicing work in accordance with the specifications.

## Fluids in the air conditioning system

### Refrigerant in the air conditioning system

The sticker in the engine compartment contains information regarding the type and quantity of refrigerant used in the vehicle's air conditioning system. The sticker is located at the front of the engine compartment, close to the coolant filler neck.



Warning: the air conditioning system must always be serviced by trained specialists.



Type of refrigerant.



Type of refrigerant oil.



See workshop information (available only for Volkswagen dealerships).



The air conditioning system must always be serviced by trained specialists.



Flammable refrigerant.



Make sure you dispose of all components correctly and never install components taken from older vehicles or recycling facilities into the vehicle.

### Refrigerant oil in the air conditioning system

The air conditioning system is filled with a refrigerant oil. The label on the air conditioning compressor states the type and amount of refrigerant oil used → page 362.

#### **WARNING**

In order to ensure safe and risk-free operation, always have the air conditioning system serviced by specialists who are qualified to perform this task.

#### **NOTICE**

- Never repair the air conditioning system's evaporator using spare parts taken from older vehicles or recycling facilities, or other such spare parts.

## Infotainment system and antennas

The aerials for the Infotainment system are installed at different points in the vehicle:

- On the inside of the rear window.
- On the inside of the rear side windows.
- On the inside of the windscreen.
- On the roof of the vehicle.

Aerials on the interior of the windows can be identified as thin wires.

### NOTICE

Aerials located on the inside of the windows could be damaged by corrosive or acidic substances or if hard objects rub against the window.

- Do not affix any stickers over metal wires, e.g. in the area of the rear window.
- Never clean the aerials with corrosive or acidic agents.

### NOTICE

A retrofitted Infotainment system must be compatible with the aerial amplifier fitted as standard in the vehicle. The aerial amplifier could otherwise be damaged.

## Component protection

Some electronic components and control units are fitted with component protection as standard, e.g. the Infotainment system.

The component protection permits a correspondingly qualified workshop to legitimately install or replace components and control units. Volkswagen recommends using a Volkswagen dealership.

The component protection prevents the full operation of factory-supplied components outside the vehicle in the following situations:

- Installation in other vehicles, e.g. after theft.
- Operation of components outside the vehicle.

If a text message about component protection appears in the display of the instrument cluster or the screen of the Infotainment system, go to a correspondingly qualified workshop. Volkswagen recommends using a Volkswagen dealership.

## Information in accordance with the EU Chemicals Regulation REACH

In accordance with the European regulations on chemicals, known as REACH, Volkswagen would like to inform you about the substances that may be found in your vehicle.

You can access this information online using your vehicle identification number → page 388:

<https://reachinfo.volkswagen.com>

## Disposal of used batteries and electronic devices

### Used batteries

Used batteries must be collected separately and recycled by the end user. This is indicated by the symbol with the crossed-through waste bin . As the end user, you are subject to the legal obligation to return used batteries.

Batteries that contain heavy metals are marked with the chemical symbols Hg (mercury), Cd (cadmium) and/or Pb (lead). Heavy metals can damage the health of human beings and animals and can accumulate in the environment. In order to avoid these consequences, you must ensure separate collection and proper return of used batteries.

Special care must be taken when handling batteries containing lithium, e.g. they must never be heated to high temperatures or become physically damaged. If gases or fluids escape, they can pose a significant risk to health and the environment. A short circuit of the terminals can also cause a fire or explosion.

- Used batteries can be returned to the Volkswagen dealership in EU member states and other countries.
- Further information on return and recycling can be obtained from your Volkswagen dealership.

### Old electrical/electronic devices

Your vehicle contains electrical and electronic devices such as the SD card in the navigation system and remote controls. These devices are marked with a symbol showing a crossed-through waste bin .

The corresponding legal regulations stipulate that old devices with this marking must be collected and disposed of separately from normal household waste. You can hand in these devices at local collec-

tion points or any nationally authorised return systems.

- Batteries, rechargeable batteries or lamps that are not a fixed part of the device must be removed first and disposed of accordingly.
- You are responsible for deleting any personal data that is stored on the old devices.

Further information on return and recycling can be obtained from your Volkswagen dealership.

## Declaration of conformity for components not related to radio equipment

The corresponding manufacturer hereby declares that the components listed below were compliant with the basic requirements and any other relevant regulations and laws at the time the vehicle was produced.

**UK**  
**CA** Approval symbols for radio systems in England, Wales and Scotland (expected in-production in 2021).

Importer:

Volkswagen Group United Kingdom Ltd.

Yeomans Drive, Blakelands

Milton Keynes, MK 14 5AN

United Kingdom

### Components

- 12-volt socket.
- Depending on the vehicle equipment and country, additional sockets with a voltage of 100 to 230 volts → page 212.
- Airbags
- Vehicle toolkit
- Entry light and torch
- Fire extinguisher
- Belt tensioner
- Compressor
- Headphones
- Charger
- Charge cable
- Pyrotechnic fuse
- SD Card
- Actuators
- First aid kit

- High-visibility waistcoat
- Jack

## Third party copyright law information

<http://www.volkswagen.com/softwareinfo>

Some of the products installed in the vehicle contain software components for which Open Source licences are required.

A list of the Open Source software components used including information on copyright laws as well as the respective Open Source licence conditions and the corresponding licence text is available via the aforementioned website. The source code of certain Open Source software components can be requested from the manufacturer of the vehicle. The manufacturer will provide you with the source code according to the respective licence conditions, whereby you will only be charged with the cost of making it available (for example, costs for the data storage device and postage and packing). You can find the required information at the aforementioned website.

## Returning and scrapping end-of-life vehicles

### Returning end-of-life vehicles

At the end of its life, your vehicle must be recycled and disposed of in an environmentally appropriate way. For this reason, the last vehicle keepers in the EU and many other countries are required by law to take their vehicle to an approved collection point, vehicle return centre or authorised dismantling facility.

Volkswagen has already made the corresponding preparations for this: a comprehensive network of vehicle return centres is available in all EU countries and many other countries, where you can hand over your vehicle. If you satisfy the national legal requirements, you can return your end-of-life vehicle free of charge within the EU.

The vehicle return centre issues a recycling certificate which serves as proof that the end-of-life vehicle has been recycled properly.

You can obtain information about vehicle return centres from your Volkswagen dealership.

## Scrapping

The relevant safety requirements must be observed when scrapping the vehicle or its individual components, e.g. the airbag system and belt tensioners. These requirements are known to the correspondingly qualified workshops. Volkswagen recommends using a Volkswagen dealership. <

## Information about vehicles with N1 approval (light commercial vehicle)

Please observe the following for vehicles used to transport goods with a maximum permitted weight of up to 3.5 t (N1 approval in Europe):

### Variants and number of seats

There are a number of designs for N1 vehicles based on a Volkswagen passenger car. The number of seats may be restricted to two or four.

*Vehicles with two seats:* there is no floor covering in the rear of the vehicle interior because there is no rear bench seat → ⚠.

*Vehicles with four seats:* the centre seat on the rear bench seat **cannot be used** → ⚠.

### Transporting children safely

As in vehicles with passenger car approval (M1), approved child restraint systems can be used on the seats → page 58.

### Trailer towing

If the vehicle is approved for towing a trailer, observe any local regulations for driving with a trailer and using a towing bracket.

If the vehicle exceeds the permitted gross weight or axle load for the rear axle, a speed of 80 km/h (50 mph) must not be exceeded when towing a trailer. This also applies to countries where higher speeds are permitted. Observe local speed limits. These may be lower for vehicles with trailers than for vehicles without trailers.

Any permitted excess loads for the vehicle are entered in the vehicle documents. If no permitted excess load is entered, the permitted driving speed limit is 100 km/h (62 mph) taking into account country-specific legislation.

### Technical data

Technical data can be found in the vehicle documents.

### ⚠ WARNING

Risk of injury and electric shock from exposed wires.

- Ensure the luggage compartment trim is installed upon or before delivery, so that the cables in the rear of the vehicle are covered up when using the vehicle.

### ⚠ WARNING

Risk of severe injuries due to persons being transported incorrectly.

- Never drive with an adult or child sitting in the middle of the rear bench seat. The lack of restraint systems such as seat belt and head restraint can result in serious or fatal injury in the event of an accident.

### ⚠ WARNING

Risk of severe and fatal injuries.

- Never transport people in the luggage compartment.
- Observe the safety notes and information regarding the luggage compartment and transporting items → page 266. <

# Information on radio equipment regulations

## Declaration of Conformity for radio systems in the European Union (EU)

### Simplified EU Declaration of Conformity

Your vehicle is equipped with various radio systems. The manufacturers of these radio systems declare that this equipment complies with Directive 2014/53/EU where required by law.

The complete text of the EU declaration of conformity is available at the following internet address:

[www.volkswagen.com/generalinfo](http://www.volkswagen.com/generalinfo)



The corresponding legal regulations stipulate that radio equipment with this marking must be collected and disposed of separately from normal household waste. You can hand in these devices at local disposal centres or any nationally authorised return systems → page 370.



Marking for the restricted use of certain hazardous substances in electrical and electronic equipment in accordance with the RoHS Directive.

### Manufacturers' addresses

For components that, due to their size or nature, cannot be provided with a sticker, the respective manufacturers' addresses as required by law are listed here:

#### Door handle with NFC radio technology

HELLA GmbH & Co. KGaA

Rixbecker Straße 75

59552 Lippstadt

GERMANY

WITTE VELBERT GmbH & Co. KG

Höferstraße 3-15

42551 Velbert

GERMANY

#### Remote control (auxiliary heater), auxiliary heater (transmitter and receiver unit)

Digades GmbH

Äußere Weberstraße 20

02763 Zittau

GERMANY

Webasto Thermo & Comfort SE

Friedrichshafener Straße 9

82205 Gilching

GERMANY

#### Tyre pressure sensors

HUF Baolong Electronics Bretten GmbH

Gewerbestraße 40

75015 Bretten

GERMANY

### Mapping tables

What the two letters in the tables mean (e.g. AF) → page 376, *Frequency band, maximum transmission power.*

#### Safety

This section contains the certificate numbers of the following components:

— *Garage door opener, Keyless Access, vehicle key, instrument cluster, ID. Cockpit, electronic immobiliser.*

#### Garage door opener:

ADHLS0, EHL2	AG
ADHLS0, EHL2	AK

#### Keyless Access:

RSB19	AO
Kessy MQB37W	AF
Kessy MQB-A, 5ZA 010 176, MQB-B B, MQB-B H,	AC
013854	AD
VWTOUA PKETOUA	AJ

#### Remote control key (vehicle):

VK2, FS19	AF
FS09, FS12A, FS12P, FS12PM, FS125C, FS14, FS14K, FS14T, AI FS14TK, FS1744, FS1744M, FS94	AI
VWTOUA RKETOUA	AJ

<i>Instrument cluster, electronic immobiliser:</i>	
COLOUR5C, MEDIUM 5C	AB
eNSF, LCW05-VWE1, LCW05-VWE5, LCW05-SEES, EZS-VW-Touareg, Immobilizer integrated in dashboard module instrument cluster, 17101001, 17101002, 17101010, 17101021, 17101022, 17101023, 17101031, 17101032, 17101033, 17101034, 17101041, 17101042, 17101043, 17101051, 17101052, 17101053, 17101054, 17101055, 17101056, 17101057, 17101071, 17101072, 18020501, 18020531, 18020532, 18020533, 18020534, 18031410, 18100931	AC
FPK8 IMMO5D, Instrument cluster 1, Instrument cluster 2, Instrument cluster 3, BNF_HL, BNF_LL, NSF_HL, NSF_LL1, NSF_LL3	AD
MQB_AO Clusters, MQBG01, MQBM01, MQBS01	BE
DTCO 1381	AT
EFAS-4.10	

### Air Conditioning

This section contains the certificate numbers of the following components:

- Remote control (auxiliary heater), auxiliary heater (transmitter and receiver unit).

#### Remote control (auxiliary heater):

EasyStart R, STH VW - 50000884, STH VW D- 50001194, Tel-estart	AK
--	----

#### Auxiliary heater (transmitter and receiver unit):

50000864 D208L VW, 50001219 D208L VW	AK
--------------------------------------	----

### Tyres

This section contains the certificate numbers of the following components:

- Tyre pressure sensors.

#### Tyre pressure sensors:

AG2FW4, TSSRE4Dg, TSSRE4Uf, TSSSG4G5, TSSSG4G5b	AG
---	----

### Control unit

This section contains the certificate numbers of the following components:

- Central control unit, door control unit, valet key-card, wireless charging function, wireless seat belt warning system.

#### Central control unit:

5WK50254	AH
BCM MQB37W, MQB37W	AF
KFG: Max	BG
BCM2, BCM2R, BCMeVo, BCMeVoC, BCMeVo5	BH
BCM MQB27, BCM PQ25, BCM PQ35, BCM PQ37H, BR11, 5WK50248,	XX
BC-Module, BCM PQ26 ROW (502N1xF0x), 5WK50474	

#### Door control unit:

HUF71110, HUF71254, DHA20, NFCTGS, Mobile Key 4K0.959.754.xx, 3G0.837.205, 3G0.837.206	AD
--	----

CDIS 2.0	BD
----------	----

#### Wireless charging function:

WCH-185, WCH-186, WPC003-1	AA
Koppelantenne Gen.3, 3G0.980.611	BK

#### Wireless seat belt warning system:

wSBR F-SG, wSBR S-SG	AL
----------------------	----

### Driver assist systems

This section contains the certificate numbers of the following components:

- Radar sensors for assist systems.

#### Radar sensors for assist systems:

LCA 2.0A, BSD 3.0	AP
RS4	AQ
ARS4-B, ARS5-B, FR5CPEC, LRR3, MRR1Plus, LRR4, MRR1Rear, LRR4R, MRRRe14FCR, MRRRe14F, R3TR	AR

### Infotainment system and online communication

This section contains the certificate numbers of the following components:

- Infotainment system, Bluetooth, Wi-Fi hotspot, mobile phone interface, OCU, Volkswagen Car-Net "Security & Service", Volkswagen Car-Net "e-Remote".

#### Infotainment system:

New Radio Ultra Low SBB, New Radio Ultra Low SBB DAB, New Radio Ultra Low SBT, 7C0.035.153, 7LA.035.153.A, Radio Ultra Low Touch, Radio Ultra Low Touch DAB	AL
A473/A476/A750, A475/A754, L40VW2, L41VW2, L42VW2, L53VW2, L56VW2, L62VW2, L69VW2, L73VW2, L77VW2, MIB Global Entry/Standard, MIB2, MIB2 PQ MIN, MIB2STD, MIB Standard 2 - PQ +NAV with BT, MIB Standard 2 - ZR with BT, MIB Standard 2 - ZR +/Nav with BT, MIB3E_MQB_BT, MIB3E_MQB37w_BT, OE-PP 87BT	AL
MIB3TOP	AV
MEB ICAS3	AW
MIB3 OI (LGE)	AX
MIB3 OI	AY
MIB Standard 2 - ZR +/Nav mit BT and WLAN, MIB Standard 2 - PQ +/NAV with BT and WLAN, MIB2STD Nav, MIB2STD Radio	AZ
MIB3E_MQB_BTWIFI, MIB3E_MQB37w_BTWIFI	BA
A580/A270	BB
MIB HS	BC
MMI3G	BF
MMI3G RU	XX
RRVW402B, RRVW401*, RRVW402*	XX

#### Bluetooth:

HT-5	BI
------	----



**Wi-Fi hotspot:**

HT-5	BI
CCU4	BJ

**Mobile phone interface:**

HT-5	BI
------	----

**Online connectivity unit (OCU):**

DataPlug	AL
HT-6d, HT-6e, TUVMO1IU-G, TUVMO2IU-C, TUVMO2IU-E, TUVMO3IU-C, TUVMO3IU-E	AS
TLAHW3IU-E, TLAHW3IU-R, TLVHM3IU-E, TLVHM3IU-R, TLVHW3IU-E, TLVHW3IU-R, TLVLM3IU-E, TLVLM3IU-R, TLVHE4IU-E, TLVHE4IU-R	AU

**Aerials**

This section contains the certificate numbers of the following components:

— *Aerials, aerial amplifier, connection to the external aerial.*

**Connection to the external aerial:**

LTE-MBC-EU, LTE-MBC-EU2	BC
CM01TN-VVWV	AN
UMTS/GSM-MMC, UMTS/GSM-MMC-AG2, UMTS/GSM-MMC-AG3	AS

**Aerial amplifier:**

CSA-1	AN
DDAECE01, 4N0.035.503.E, 4N0.035.503.F, 4N0.035.503.J, 4N0.035.503.L, 4N0.035.503.M, 4N0.035.503.Q, 4N0.035.503.AB, 4N0.035.503.AC, 4N0.035.503.AF, 4N0.035.503.AG,	AL
0-07-26-1912-00, 756xxxx,	XX
10A.035.577.A, 10A.035.577.B, 10A.035.577.C, 10A.035.577.D, 11A.035.577.A, 11A.035.577.B, 11A.035.577.C, 11A.035.577.D, 11A.035.577.F, 11A.035.577.M, 11E.035.577.A, 11E.035.577.B, 11E.035.577.C, 11E.035.577.D, 150.035.577.A, 2G0.035.577.A, 2GA.035.577, 2GA.035.577.A, 2GA.035.577.B, 2GM.035.577.A, 250.035.577.A	XX
3G5.035.577, 3G5.035.577.A, 3G5.035.577.B, 3G5.035.577.G, 3G5.035.577.H, 3G5.035.577.J, 3G5.035.577.K, 3G7.035.577.A, 3G7.035.577.B, 3G7.035.577.D, 3G8.035.577, 3G8.035.577.A, 3G8.035.577.B, 3G8.035.577.E, 3G8.035.577.F, 3G8.035.577.G, 3G8.035.577.H, 3G8.035.577.J, 3G8.035.577.K, 3G9.035.577, 3G9.035.577.A, 3G9.035.577.B, 3G9.035.577.G, 3G9.035.577.H, 3G9.035.577.J, 3G9.035.577.K, 3V5.035.577.A, 3V5.035.577.B, 3V5.035.577.F, 450.035.225.A, 450.035.225.D,	XX
510.035.577, 510.035.577.A, 510.035.577.B, 565.035.577.A, 565.035.577.C, 575.035.225, 575.035.225.A, 575.035.225.B, 5C3.035.552, 5C3.035.552.A, 5C3.035.552.B, 5C5.035.552, 5C5.035.552.A, 5C5.035.552.B, 5E5.035.577.A,	XX

5E5.035.577.B, 5E6.035.577, 5E6.035.577.A, 5E6.035.577.B, 5E7.035.577, 5E7.035.577.A, 5E7.035.577.B, 5F4.035.225, 5F4.035.225.A, 5F4.035.225.B, 5G6.035.577, 5G6.035.577.A, 5G6.035.577.B, 5G6.035.577.E, 5G6.035.577.F, 5G9.035.577, 5G9.035.577.A, 5G9.035.577.B, 5G9.035.577.G, 5G9.035.577.H, 5G9.035.577.J, 5G9.035.577.K, 5L0.035.501.A, 5LE.035.577, 5LE.035.577.A, 5LG.035.577, 5LG.035.577.A, 5NA.035.577, 5NA.035.577.A, 5NA.035.577.B, 5NA.035.577.E, 5NA.035.577.F, 5TA.035.577, 5TA.035.577.A, 5TA.035.577.B,	
6C0.035.501, 6C0.035.501.A, 6C0.035.501.C, 6C0.035.501.D, 6C0.035.501.G, 6C0.035.501.J, 6C0.035.501.N, 6C0.035.501.P, 6C0.035.501.Q, 6C0.035.577, 6C0.035.577.P, 6C0.035.577.Q, 6R0.035.501, 6R0.035.501.A, 6R0.035.501.C, 6R0.035.501.D, 6R0.035.501.F, 6R0.035.501.L, 6V6.035.577.A, 6V6.035.577.B, 6V9.035.577.A, 6V9.035.577.B, 760.035.577, 760.035.577.A, 760.035.577.S, 760.035.577.T, 7C0.035.501, 7C0.035.501.C, 7C0.035.501.D, 7C0.035.501.F, 7C0.035.501.G, 7H0.035.507.E, 7N0.035.552.J, 7N0.035.552.K, 7N0.035.552.Q, 7P6.035.552, 7P6.035.552.A, 7P6.035.552.M, 7T0.035.507.A, 7T0.035.507.B, 7T0.035.507.E, 7T0.035.507.F, 7T0.035.510, 7T0.035.577.A, 7T0.035.577.B, 7T0.035.577.C, 7T0.035.577.D, 857.035.503.B	
920 105 105, 920 105 110, 920 211 072, 920 211 172, 920 211 201, 920 211 202, 920 213 172, 920 286 002, 920 286 005, 920 286 009, 920 286 010, 920 286 011, 920 286 012, 920 286 013, 920 286 015, 920 286 313, 920 286 323, 920 286 343, 920 286 351, 920 286 352, 920 286 353, 920 286 354, 920 286 362, 920 286 382, 920 286 383, 920 286 385, 920 286 386, 920 301 022, 920 301 030, 920 301 031, 920 301 041, 920 301 042, 920 304 022, 920 355 001,	XX
920 437 003, 920 437 023, 920 437 035, 920 437 303, 920 437 323, 920 437 335, 920 460 003, 920 460 009, 920 460 018, 920 460 025, 920 460 028, 920 460 042, 920 460 047, 920 460 069, 920 460 303, 920 460 318, 920 460 325, 920 460 328, 920 460 342, 920 460 347, 920 460 369, 920 461 001, 920 461 002, 920 461 003, 920 461 004, 920 461 005, 920 554 001, 920 554 002, 920 554 003, 920 554 004, 920 554 011, 920 554 012, 920 554 013, 920 554 014, 920 611 001, 920 611 002, 920 611 011, 920 611 012, 920 615 001, 920 615 002, 920 627 A, 920 627 B, 920 627 003, 920 627 007, 920 627 011, 920 627 012, 920 627 017, 920 627 018, 920 627 023, 920 627 024, 920 627 048, 920 627 049, 920 627 051, 920 627 054, 920 627 055, 920 627 056, 920 639 A, 920 639 001, 920 639 002, 920 639 003, 920 639 011	XX

**Aerials:**

DSRC CAN Module / EFAS-4 DU (200046-8), DSRC CAN Module / EFAS-4 DU (200046-9)	AM
AM/FM1/DAB2/TV ECE (Impedance Converter)	
3789.01, 754xxxx, 76xxxxx, 77xxxxx, 790xxxx, 7540xxx, 7542xxx	XX

1K8.035.552.C, 1K8.035.552.F, 2GA.035.577.B, 2GC.035.577.A, 2GC.035.577.S, 2K5.035.525.L, 2K5.035.525.M, 2K5.035.525.Q, 2K5.035.525.T, 2K5.035.525.AB, 2K5.035.525.AC, 2K5.035.525.AD, 2K5.035.525.AE, 2K5.035.526.L, 2K5.035.526.M, 2K5.035.526.Q, 2K5.035.526.T, 2K5.035.526.AA, 2K5.035.526.AB, 2K5.035.526.AC, 2K5.035.526.AD, 2K5.035.526.AE, 2K5.035.526.AF, 2K5.035.532.Q, 2K5.035.532.R, 2K5.035.532.S, 2K5.035.540.A	XX	5QD.035.507.AH, 5QG.035.507.AG, 5QG.035.507.AH, 5WA.035.507.A, 5WA.035.507.B, 5WA.035.507.E, 5WA.035.507.F, 5WA.035.507.T, 5WD.035.507.A, 5WD.035.507.B, 5WD.035.507.E, 5WD.035.507.F, 5WG.035.507.A, 5WG.035.507.B, 5WG.035.507.E, 5WG.035.507.F, 6CO.035.501.FQ, 6RO.035.501.F, XX 7E0.035.503, 7E0.035.503.A, 7E0.035.503.B, 7E0.035.503.C, XX 7E0.035.503.D, 7E0.035.503.E, 7E0.035.510, 7E0.035.510.A, 7N0.035.507.A, 7N0.035.507.B 920 336 003, 920 336 005, 920 336 006, 920 336 007, 920 XX 336 008, 920 336 010, 920 336 011, 920 336 012, 920 336 013, 920 336 014, 920 417 007, 920 417 010, 920 481 002, 920 481 003, 920 481 004, 920 481 012, 920 481 013, 920 481 014.
3C0.035.507.AA, 3C0.035.507.N, 3C0.035.507.P, 3V5.035.577.A, 3V5.035.577.F, 4G5.035.225.A, 4G5.035.225.B, 4G8.035.225.A, 4G8.035.225.B, 4G9.035.225.A, 4G9.035.225.B, 4N0.035.503.L	XX	
5Q0.035.507.A, 5Q0.035.507.AG, 5Q0.035.507.AH, 5Q0.035.507.B, 5Q0.035.507.C, 5Q0.035.507.P, 5Q0.035.507.Q, 5Q0.035.507.S, 5QD.035.507.AG,	XX	

## Frequency band, maximum transmission power

If not otherwise stated, the specifications apply to all Volkswagen models or to vehicles that are equipped with the respective radio system.

In certain countries, the activation of, or permission to use, radio technology may be restricted, not possible, or only possible when additional requirements have been fulfilled.



🌐 Referenced radio systems (e.g. AA)  
→ page 373, *Mapping tables*.

📶 Frequency band.

📶 Maximum transmission power.

μW = Microwatt, mW = Milliwatt, W = Watt.

🌐	📶	📶
AA	105 kHz – 115 kHz	6 W
AB	116 kHz – 134 kHz	148,70 dBμV/m
AC	125 kHz +/- 10 kHz	5,4 dBμA/m
AD	125 kHz	40 dBμA/m
AE	13,56 MHz	14,5 mW
AF	433,05 MHz – 434,79 MHz	15 dBm EIRP
AG	433,92 MHz	10 mW
AH	433,92 MHz, 434,42 MHz	5 dBm EIRP
AI	434,42 MHz	25 mW
AJ	433,47 MHz – 434,37 MHz 868,00 MHz – 868,60 MHz	-17 dBm -17 dBm
AK	868,0 MHz – 869,2 MHz	25 mW
AL	2400 MHz – 2483,5 MHz	10 mW
AM	5795 MHz – 5815 MHz (DSRC)	0,04 mW
AN	5855 MHz – 5925 MHz	2 W EIRP
AO	6,0 GHz – 8,5 GHz (6,52 GHz, 7,04 GHz, 7,56 GHz)	0 dBm EIRP
AP	24,05 GHz – 24,25 GHz	0,05 W
AQ	24,075 GHz – 24,250 GHz	15,1 dBm EIRP
AR	76,0 GHz – 77,0 GHz	35 dBm EIRP
AS	GSM 900 (uplink: 880 MHz – 915 MHz / downlink: 925 MHz – 960 MHz) GSM 1800 (uplink: 1710 MHz – 1785 MHz / downlink: 1805 MHz – 1880 MHz) WCDMA FDDI (uplink: 1920 MHz – 1980 MHz / downlink: 2110 MHz – 2170 MHz) WCDMA FDDVIII (uplink: 880 MHz – 915 MHz / downlink: 925 MHz – 960 MHz)	2 W 1 W 0,25 W 0,25 W

		
AT	5,795 GHz – 5,815 GHz (DSRC) 1599 MHz – 1610 MHz (GNSS)	-19,9 dBm EIRP
AU	WCDMA Band 1: 1922,4 MHz – 1977,6 MHz, WCDMA Band 3: 1712,4 MHz – 1782,6 MHz, WCDMA Band 8: 882,4 MHz – 912,6 MHz	23,35 dBm
AU	LTE Band 1: 1920 MHz – 1980 MHz, LTE Band 3: 1710 MHz – 1785 MHz, LTE Band 7: 2500 MHz – 2570 MHz, LTE Band 8: 880 MHz – 915 MHz, LTE Band 20: 832 MHz – 862 MHz, LTE Band 28A: 703 MHz – 718 MHz, LTE Band 32: 1452 MHz – 1496 MHz	22,47 dBm
AU	GSM 900: 880,2 MHz – 914,8 MHz DCS 1800: 1710,2 MHz – 1784,8 MHz GNSS: 1559 MHz – 1610 MHz	31,99 dBm 29,98 dBm --
AV	Bluetooth: 2402 MHz – 2480 MHz WLAN 2.4 GHz: 2412 MHz – 2480 MHz WLAN 5 GHz: 5745 MHz – 5850 MHz	20 mW 63 mW 25 mW
AW	Bluetooth: 2402 MHz – 2480 MHz WLAN 2.4 GHz: 2412 MHz – 2472 MHz, WLAN 5 GHz: 5150 MHz – 5250 MHz, WLAN 5 GHz: 5725 MHz – 5850 MHz	1,2 dBm EIRP 16,4 dBm EIRP
AX	Bluetooth: 2402 MHz – 2480 MHz GNSS: 1559 MHz – 1610 MHz WLAN 2.4 GHz: 2412 MHz – 2472 MHz, WLAN 5 GHz: 5150 MHz – 5250 MHz, WLAN 5 GHz: 5725 MHz – 5850 MHz	2,30 dBm EIRP -- 16,80 dBm EIRP
AY	Bluetooth: 2402 MHz – 2480 MHz WLAN 2.4 GHz: 2412 MHz – 2472 MHz, WLAN 5 GHz: 5745 MHz – 5825 MHz	8,94 dBm EIRP 16,63 dBm EIRP
AZ	Bluetooth: 2402 MHz – 2480 MHz WLAN 2.4 GHz: 2412 MHz – 2472 MHz	4,63 dBm EIRP 17,70 dBm EIRP
BA	Bluetooth: 2400 MHz – 2483,5 MHz WLAN 2.4 GHz: 2400 MHz – 2483,5 MHz, WLAN 5 GHz: 5150 MHz – 5250 MHz, WLAN 5 GHz: 5725 MHz – 5850 MHz	4,9 dBm EIRP 13,8 dBm EIRP
BB	Bluetooth: 2402 MHz – 2480 MHz WLAN: 2400 MHz – 2483,5 MHz GSM: 900/1800 MHz UMTS FDDI/III LTE FDD 3, 7, 8, 20	0,9 dBm EIRP 8 dBm EIRP 27 dBm EIRP 24 dBm EIRP 23 dBm EIRP
BC	Bluetooth: 2402 MHz – 2480 MHz WLAN: 2400 MHz – 2483,5 MHz	10 dBm EIRP 20 dBm EIRP
BC	GSM 900 (uplink: 880 MHz – 915 MHz / downlink: 925 MHz – 960 MHz) GSM 1800 (uplink: 1710 MHz – 1785 MHz / downlink: 1805 MHz – 1880 MHz)	33 dBm EIRP 30 dBm EIRP
BC	WCDMA FDDI (uplink: 1920 MHz – 1980 MHz / downlink: 2110 MHz – 2170 MHz) WCDMA FDDVIII (uplink: 880 MHz – 915 MHz / downlink: 925 MHz – 960 MHz)	24 dBm EIRP 24 dBm EIRP
BC	LTE FDD1 (uplink: 1920 MHz – 1980 MHz / downlink: 2110 MHz – 2170 MHz) LTE FDD3 (uplink: 1710 MHz – 1785 MHz / downlink: 1805 MHz – 1880 MHz) LTE FDD7 (uplink: 2500 MHz – 2570 MHz / downlink: 2620 MHz – 2690 MHz) LTE FDD8 (uplink: 880 MHz – 915 MHz / downlink: 925 MHz – 960 MHz) LTE FDD20 (uplink: 832 MHz – 862 MHz / downlink: 791 MHz – 821 MHz)	23 dBm EIRP 23 dBm EIRP 23 dBm EIRP 23 dBm EIRP 23 dBm EIRP
BD	LTE Band 1: 2100 MHz, LTE Band 3: 1800 MHz, LTE Band 5: 850 MHz, LTE Band 7: 2600 MHz, LTE Band 8: 900 MHz, LTE Band 20: 800 MHz	23 dBm
BD	UMTS Band 1: 2100 MHz, UMTS Band 2: 1900 MHz, UMTS Band 5: 850 MHz, UMTS Band 8: 900 MHz	24 dBm
BD	GSM: 850 MHz, E-GSM: 900 MHz DCS: 1800 MHz, PCS: 1900 MHz BLE: 2400 MHz – 2483,5 MHz WCDMA FDDI (uplink: 1920 MHz – 1980 MHz / downlink: 2110 MHz – 2170 MHz)	33 dBm 30 dBm 3,5 dBm
BE	125 kHz	0,56 W

🌐	📶	📡
BF	Bluetooth: 2400 MHz – 2483,5 MHz GSM/GPRS: 880,2 MHz – 914,8 MHz GSM/GPRS: 1710,2 MHz – 1784,8 MHz WCDMA Band 1: 1922,4 MHz – 1977,6 MHz, WCDMA Band 8: 882,4 MHz – 912,6 MHz	20 dBm 33 dBm 30 dBm 24 dBm
BG	Bluetooth: 2400 MHz – 2483,5 MHz WLAN: 2400 MHz – 2483,5 MHz	4 dBm EIRP 19 dBm EIRP
BH	21,13 kHz – 22,75 kHz	42 dBμA/m
BI	GSM 850 (uplink: 824 MHz – 849 MHz / downlink: 869 MHz – 894 MHz) GSM 900 (uplink: 880 MHz – 915 MHz / downlink: 925 MHz – 960 MHz) GSM 1800 (uplink: 1710 MHz – 1785 MHz / downlink: 1805 MHz – 1880 MHz) GSM 1900 (uplink: 1850 MHz – 1910 MHz / downlink: 1930 MHz – 1990 MHz) WCDMA FDDI (uplink: 1920 MHz – 1980 MHz / downlink: 2110 MHz – 2170 MHz) WCDMA FDDV (uplink: 824 MHz – 849 MHz / downlink: 869 MHz – 894 MHz) Bluetooth: 2402 MHz – 2480 MHz WLAN: 2412 MHz – 2462 MHz	2 W 2 W 1 W 1 W 0,25 W 0,25 W 0,001 W 0,1 W
BJ	WiFi IEEE 802.11 b/g/n: 2412 MHz – 2472 MHz GSM/GPRS/eGPRS 900: 880,2 MHz – 914,8 MHz GSM/GPRS/eGPRS 1800: 1710,2 MHz – 1784,8 MHz UMTS FDDI: 1922,4 MHz – 1977,6 MHz, UMTS FDDVIII: 882,4 MHz – 912,6 MHz, LTE FDD1: 1920 MHz – 1980 MHz, LTE FDD3: 1710 MHz – 1784,9 MHz, LTE FDD7: 2500 MHz – 2569,9 MHz, LTE FDD8: 880 MHz – 914,9 MHz, LTE FDD20: 832 MHz – 861,9 MHz	18,4 dBm EIRP 37,64 dBm EIRP 34,64 dBm EIRP 27,84 dBm EIRP
BK	105 kHz – 115 kHz 13,56 MHz	5 W 500 mW
XX	Keine Sendeleistung, nur Empfang	

## Declaration of Conformity for radio systems in countries outside the European Union (EU)





Fig. 262 Overview of a selection of approval symbols for radio systems.

- ① Argentina.
- ② Zambia.
- ③ Brunei.
- ④ Philippines.
- ⑤ Paraguay.
- ⑥ South Africa.

**CE** Approval symbol for radio systems in countries outside the EU where radio systems are approved and permitted according to European Directives.

**UK CA** Approval symbol for radio systems in England, Wales and Scotland (introduction probably during the course 2021).

 Approval symbol for radio systems in Ukraine.

 Approval symbol for radio systems in Brazil.



Approval symbol for radio systems in Argentina (introduction probably middle of 2022).



Approval symbol for radio systems in Malaysia.



Approval symbol for radio systems in Australia or in Australia and New Zealand.



Approval symbol for radio systems in New Zealand.



Approval symbol for radio systems in Russia and in countries where radio systems are approved and permitted according to EAC Directives.



Approval symbol for radio systems in Vietnam.



Approval symbol for radio systems in Belarus.



Approval symbol for radio systems in Serbia.



Approval symbol for radio systems in the USA and countries where radio systems are approved and permitted according to the US FCC Directive.



Approval symbol for radio systems in Armenia.



Approval symbol for radio systems in Mongolia.



Approval symbol for radio systems in Sierra Leone.

The manufacturer hereby declares that the following radio systems are in compliance with the basic requirements and other relevant regulations and laws at the time of production of the vehicle:

*The following radio systems are not available in every market and not in every vehicle.*

- Connection to the external aerial.
- Aerial.

- Aerial amplifier.
- Bluetooth.
- Remote control (auxiliary heater).
- Vehicle key.
- Garage door opener.
- ID. Cockpit.
- Infotainment system.
- Keyless Access.
- Instrument cluster, electronic immobiliser.
- Radar sensors for assist systems.
- Tyre pressure sensors.
- Auxiliary heater (transmitter/receiver unit).
- Control units with embedded eSIM card.
- Mobile phone interface.
- Volkswagen Car-Net control unit.
- WLAN hotspot.
- Central control unit.



The corresponding legal regulations stipulate that radio equipment with this marking must be collected and disposed of separately from normal household waste. You can hand in these devices at local disposal centres or any nationally authorised return systems → page 370.



Marking for the restricted use of certain hazardous substances in electrical and electronic equipment in accordance with the RoHS Directive.

### The Radio Equipment Regulations 2017

This vehicle has various radio equipment devices installed. The following acts as importer of the radio equipment devices for the United Kingdom market within the meaning of The Radio Equipment Regulations 2017:

Volkswagen Group United Kingdom Ltd.

Yeomans Drive, Blakelands

Milton Keynes, MK 14 5AN

United Kingdom

### SIMPLIFIED UK DECLARATION OF CONFORMITY

Hereby, ADC Automotive Distance Control Systems GmbH declares that the radio equipment type ARS4-B is in compliance with Radio Equipment Regulations of the United Kingdom. The full text of the UK declaration of conformity is available at the following internet address: <http://continental.automotive-approvals.com/>

– Frequency band: 76 – 77 GHz. Transmission power: 3.16 W (35 dBm RMS EIRP).

Hereby, Hella GmbH & Co. KGaA declares that the radio equipment type RS4 is in compliance with Radio Equipment Regulations of the United Kingdom. The full text of the UK declaration of conformity is available at the following internet address: [www.hella.com/vag](http://www.hella.com/vag)

– Frequency band: 24.05 – 24.25 GHz. Transmission power: 20 dBm (max.) EIRP.

Hereby, HELLA GmbH & Co. KGaA declares that the radio equipment type RSB19, 013854 is in compliance with Radio Equipment Regulations 2017. The full text of the UK declaration of conformity is available at the following internet address: [www.hella.com/vag](http://www.hella.com/vag)

## Approval numbers

### Egypt

TAC.07021815923.WIR, TAC.24061918671.WIR,  
TAC.24061918672.WIR, TAC.24062020438.WIR

### Algeria

Agréé par l' ARPT:

1247/TR/AGR/PC/ARPT/2017, 31.AF/528/DT/DG/ARPT/18

Homologué par l'ANF:

CC: 53/H/ANF/2021

### Argentina

CNC C-8752, CNC C-13277, CNC C-13393, CNC C-13823,  
CNC C-14175, CNC C-14176, CNC C-14387, CNC C-14451,  
CNC C-14520, CNC C-14733, CNC C-15807, CNC C-16345,  
CNC C-16741, CNC C-17908, CNC C-18005, CNC C-18053,  
CNC C-20288, CNC C-20323, CNC C-21797, CNC C-22036,  
CNC C-22292, CNC C-22394, CNC C-23301, CNC C-23776,  
CNC C-24233, CNC C-24447, CNC C-25101, CNC C-25102

CNC H-12804, CNC H-15700, CNC H-16681, CNC H-17001,  
CNC H-17562, CNC H-17563, CNC H-17567, CNC H-17568,  
CNC H-20369, CNC H-20370, CNC H-20497, CNC H-20718,  
CNC H-20731, CNC H-20732, CNC H-20733, CNC H-21049,  
CNC H-21050, CNC H-21796, CNC H-21901, CNC H-21902,  
CNC H-21961, CNC H-21962, CNC H-22190, CNC H-22191,  
CNC H-22192, CNC H-22240, CNC H-22301, CNC H-22302,  
CNC H-22362, CNC H-22363, CNC H-22364, CNC H-22377,  
CNC H-22378, CNC H-22379, CNC H-22380, CNC H-22381,  
CNC H-22382, CNC H-22390, CNC H-22391, CNC H-22383,  
CNC H-22524, CNC H-22793, CNC H-22794, CNC H-22855,  
CNC H-22856, CNC H-22961, CNC H-23129, CNC H-23480,  
CNC H-23481, CNC H-23844, CNC H-24102, CNC H-24153,  
CNC H-24261, CNC H-24442, CNC H-24559, CNC H-24598,  
CNC H-24931.

### Armenia

AST-016/S.A-0281-2020

### Benin

AGREE PAR L'ARCEP BENIN

Numéro d'agrément\_Date d'agrément:

016ARCEPSEDJPCDARGU2021\_2021\_02\_04  
069ARCEPSEDRDAJRCGU2019\_2019\_04\_16  
073ARCEPSEDRDAJRCGU2019\_2019\_04\_16  
074ARCEPSEDRDAJRCGU2019\_2019\_04\_16  
115ARCEPSEDRDAJRCGU2019\_2019\_07\_03  
123ARCEPSEDRDAJRCGU2018\_2018\_06\_27  
124ARCEPSEDRDAJRCGU2018\_2018\_06\_27  
124ARCEPSEDRDAJRCGU2019\_2019\_07\_12  
173ARCEPSEDRDAJRCGU2018\_2018\_09\_12

### Botswana

BTA REGISTERED No:

BOCRA/TA/2018/2026, BOCRA/TA/2018/3012, BOCRA/TA/2018/3941,  
BOCRA/TA/2018/3991, BOCRA/TA/2018/3992, BOCRA/TA/2018/4129,  
BOCRA/TA/2018/4130, BOCRA/TA/2018/4131, BOCRA/TA/2018/4132,  
BOCRA/TA/2018/4133, BOCRA/TA/2018/4134, BOCRA/TA/2018/4135,  
BOCRA/TA/2018/4136, BOCRA/TA/2018/4193, BOCRA/TA/2018/4194,  
BOCRA/TA/2018/4195, BOCRA/TA/2018/4196, BOCRA/TA/2019/2174,  
BOCRA/TA/2019/4311, BOCRA/TA/2019/4648, BOCRA/TA/2019/4649,  
BOCRA/TA/2019/4701, BOCRA/TA/2019/4997, BOCRA/TA/2019/4998,  
BOCRA/TA/2019/5045, BOCRA/TA/2019/5046, BOCRA/TA/2019/5079,  
BOCRA/TA/2020/3991, BOCRA/TA/2020/3992, BOCRA/TA/2020/5158,  
BOCRA/TA/2020/5159, BOCRA/TA/2020/5191, BOCRA/TA/2020/5470,  
BOCRA/TA/2021/6187

BOCRA/TA/3372.

### Brazil

Para maiores informações, consulte o site da ANATEL - [www.anatel.gov.br](http://www.anatel.gov.br).

00231-20-09215, 00716-15-03745, 00720-19-05364,  
00939-19-06673, 01138-12-02856, 01202-15-06815,  
01618-20-02149, 01760-20-02149, 01812-19-05364,  
01813-19-05364, 01814-19-05364, 01834-18-02856,  
02018-18-04557, 02144-17-03430, 02393-19-05364,  
02450-17-02010, 02452-17-02010, 02992-14-06673,  
03184-18-05364, 03323-18-02930, 03563-17-05364,  
03595-17-06828, 03604-16-05364, 03764-17-05386,  
03833-18-06353, 03834-18-06353, 04057-14-06068,  
04282-19-01925, 04383-18-06673, 04708-15-05364,  
04998-19-02405, 04999-19-02405, 05031-16-06324,  
05273-18-02496, 05292-18-06353, 05293-18-06353,  
05296-18-06353, 05297-18-06353, 05310-19-10188,  
05505-18-06353, 05506-18-06353, 05507-18-06353,  
05508-18-06353, 05509-18-06353, 05511-18-06353,  
05512-18-06353, 05531-16-02149, 05674-16-06830,  
05676-19-01925, 06215-16-03430, 06763-18-06353,  
06950-18-10457, 06962-18-06353, 07084-18-03745,  
07137-19-08137, 07183-18-06353, 07184-18-06353,  
07185-18-06353, 07186-18-06353, 07188-18-06353,  
07189-18-06353, 07191-18-06353, 07830-17-08001,

08057-19-05179, 09275-19-06353, 10313-20-06353,  
12001-20-10944, 13806-20-09215

Este equipamento não tem direito à proteção contra interferência prejudicial e não pode causar interferência em sistemas devidamente autorizados.

0148-15-7978, 0263-16-9946, 0278-15-7978,  
0456-15-9946, 0646-13-5452, 0716-15-3745,  
0850-13-3745, 0918-14-5364, 0939-14-2856,  
0940-14-2856, 1140-12-2856, 1140-14-2856,  
1202-14-6815, 1497-14-9946, 1498-14-9946,  
1546-10-2886, 1690-15-5364, 1711-12-5364,  
2115-15-6815, 2220-14-3745, 2230-14-3745,  
2294-15-3616, 3002-09-3745, 3080-14-6828,  
3557-15-5364, 4057-14-6068,

02128-16-05364, 02530-16-09946, 03323-18-02930,  
05531-16-02149, 05674-15-06830, 05674-16-06830,  
07084-18-03745.

Este equipamento opera em caráter secundário, isto é, não tem direito à proteção contra interferência prejudicial, mesmo de estações do mesmo tipo, e não pode causar interferência a sistemas operando em caráter primário.

#### Brunei

AITI TA No:

AA-000081, DTA-001794, DTA-001795, DTA-001977, DTA-001978,  
DTA-001983, DTA-001985, DTA-001986, DTA-002302, DTA-002306,  
DTA-002307, DTA-003623, DTA-004928, DTA-004929, DTA-005012,  
DTA-005273, DTA-005532, LPD-25389, LPD-37256, LPD-39126

DRQ-D-MAJU-02-2011-111083: DTA-001793, DTA-001981,  
DTA-001982, DTA-002433, DTA-003220, DTA-005975

#### England, Wales and Scotland

See EU Declarations of Conformities at [www.volkswagen.com/generalinfo](http://www.volkswagen.com/generalinfo).

Further information on radio systems → page 373

#### European Union (EU) and countries where radio systems are approved according to EU Directives:

See EU Declarations of Conformities at [www.volkswagen.com/generalinfo](http://www.volkswagen.com/generalinfo).

Further information on radio systems → page 373

#### Ghana

NCA Approved:

BRE-1M-GE2-15A, BR3-1M-GE2-X72, BR3-1M-GE2-X69, BR3-1M-GE2-087,  
BR3-1M-GE2-088, BR3-1M-GE2-089, BR3-1M-GE2-09E, BR3-1M-GE2-09F,  
BR3-1M-GE2-0BA, BR3-1M-GE2-0BB, BR3-1M-GE2-0BC, BR3-1M-GE2-0BO,  
BR3-1M-GE2-0B3, BR3-1M-GE2-0B4, BR3-1M-GE2-0B7, BR3-1M-GE2-0D2,  
BR3-1M-GE2-0BA, BR3-1M-GE2-0BC, BR3-1M-GE2-0EC, BR3-1M-GE2-0ED,  
BR3-1M-GE2-0EE, BR3-1M-GE2-10A, BR3-1M-GE2-10B, BR3-1M-GE2-15A,  
BR3-1M-GE2-130, EX6-6M-GE2-17B, SRO-1M-7E4-2A9, SRO-1M-7EA-24B,

SRO-1M-7E4-25D, SRO-1M-7E4-244, SRO-1M-7E4-246, ZRO-M8-7E3-X26,  
ZRO-M8-7E3-X43, ZRO-M8-7E3-X73, ZRO-M8-7E3-X75, ZRO-M8-7E3-X90,  
ZRO-M8-7E3-X92, ZRO-M8-7E3-X96, ZRO-M8-7E3-11B, ZRO-M8-7E3-20B,  
ZRO-M8-7E3-229, ZRO-M8-7E3-27B, ZRO-1H-7E3-14E.

1R3-1M-7E1-0B7, 1R3-1M-7E1-160, 2R9-1H-7E0-XAC, 2R9-1H-7E0-X71,  
2R9-1H-7E0-X90, 2R9-1H-7E0-ODA, 3R8-8M-7DF-2AA, 6X6-4H-7E0-OF3,  
7E5-7M-X0B-RDR, 7E5-7M-X24-RDR, 7E5-7M-X74-RDR, 7E5-7M-X43-RDR.

#### Hong Kong

US0031800001, HK0011902060, HK0011902061, HK0022000048

#### India

ETA-920/2016/ERLO, ETA-1609/17-RLO(NE), ETA-SD-20190500531,  
ETA-SD-20190500547, ETA-SD-20190702496, ETA-SD-20190702597,  
ETA-SD-20190702602, ETA-SD-20200503318.

NR-ETA/1215, NR-ETA/1421, NR-ETA/2015, NR-ETA/2221, NR-ETA/7218-RLO(NR),  
NR-ETA/7219-RLO(NR), NR-ETA/7220-RLO(NR).

#### Indonesia

Certificates are available at the following Internet address [www.volkswagen.com/generalinfo](http://www.volkswagen.com/generalinfo).



Dilarang melakukan perubahan spesifikasi yang dapat menimbulkan gangguan fisik dan/atau elektromagnetik terhadap lingkungan sekitarnya.



57027/SDPPI/2018, PLG ID: 7696



57059/SDPPI/2018, PLG ID: 7696



57482/SDPPI/2018, PLG ID: 2208



60924/SDPPI/2019, PLG ID: 4334



61642/SDPPI/2019, PLG ID: 4334



61855/SDPPI/2019, PLG ID: 4334



61981/SDPPI/2019, PLG ID: 4334



62361/SDPPI/2019, PLG ID: 8837



73094/SDPPI/2021, PLG ID: 4334



62404/SDPPI/2019, PLG ID: 4334



73489/SDPPI/2021, PLG ID: 4334



64520/SDPPI/2019, PLG ID: 4334



73588/SDPPI/2021, PLG ID: 4334



67149/SDPPI/2020, PLG ID: 4334



73580/SDPPI/2021, PLG ID: 4334



67359/SDPPI/2020, PLG ID: 4334



74117/SDPPI/2021, PLG ID: 4334



67495/SDPPI/2020, PLG ID: 4334



74303/SDPPI/2021, PLG ID: 4334



67512/SDPPI/2020, PLG ID: 4334



74436/SDPPI/2021, PLG ID: 4334



69516/SDPPI/2020, PLG ID: 4334



74699/SDPPI/2021, PLG ID: 4334



72556/SDPPI/2021, PLG ID: 4334



74700/SDPPI/2021, PLG ID: 4334



72557/SDPPI/2021, PLG ID: 4334



75294/SDPPI/2021, PLG ID: 4334



72770/SDPPI/2021, PLG ID: 4334



76052/SDPPI/2021, PLG ID: 4334



72586/SDPPI/2021, PLG ID: 4334

12345/SDPPI/2011, PLG ID: 1234, 32143/SDPPI/2013, PLG ID: 3073, 32144/SDPPI/2013, PLG ID: 3073, 32221/SDPPI/2013, PLG ID: 3073, 33651/SDPPI/2014, PLG ID: 2181, 33652/SDPPI/2017, PLG ID: 2181, 34468/I/SDPPI/2017, PLG ID: 2879, 34539/I/SDPPI/2017, PLG ID: 4211, 34691/SDPPI/2014, PLG ID: 4604, 36961/SDPPI/2014, PLG ID: 4792, 38132/I/SDPPI/2017, PLG ID: 2130, 38296/I/SDPPI/2017, PLG ID: 4976, 40409/SDPPI/2015, PLD ID: 4792, 44153/SDPPI/2016, PLG ID: 4211, 47817/SDPPI/2016, PLG ID: 6094, 48732/SDPPI/2016, PLG ID: 3891, 50459/SDPPI/2017, PLG ID: 6051, 53856/SDPPI/2017, PLG ID: 4211, 55438/SDPPI/2018, PLG ID: 6051, 55776/SDPPI/2018, PLG ID: 7205, 56625/SDPPI/2018, PLG ID: 7708, 57406/SDPPI/2018, PLG ID: 7708, 57647/SDPPI/2018, PLG ID: 7708, 57687/SDPPI/2018, PLG ID: 7708, 58206/SDPPI/2018, PLG ID: 5834, 62361/SDPPI/2019, PLG ID: 8837, 67688/SDPPI/2020, PLG ID: 3813



72663/SDPPI/2021, PLG ID: 4334



72823/SDPPI/2021, PLG ID: 4334



PLG ID: 4334: 39689/SDPPI/2015, 58849/SDPPI/2018, 62443/SDPPI/2019, 62637/SDPPI/2019, 62638/SDPPI/2019, 62825/SDPPI/2019, 62826/SDPPI/2019, 62827/SDPPI/2019, 62828/SDPPI/2019, 63076/SDPPI/2019, 63077/SDPPI/2019, 63078/SDPPI/2019, 63079/SDPPI/2019, 63080/SDPPI/2019, 63081/SDPPI/2019, 63082/SDPPI/2019, 63128/SDPPI/2019, 63129/SDPPI/2019, 63130/SDPPI/2019, 63131/SDPPI/2019, 63132/SDPPI/2019, 63133/SDPPI/2019, 63134/SDPPI/2019, 63135/SDPPI/2019, 63136/SDPPI/2019, 63137/SDPPI/2019, 63138/SDPPI/2019, 63139/SDPPI/2019, 63140/SDPPI/2019, 63147/SDPPI/2019, 63160/SDPPI/2019, 63161/SDPPI/2019, 63162/SDPPI/2019, 63577/SDPPI/2019, 63578/SDPPI/2019, 63579/SDPPI/2019, 63580/SDPPI/2019, 63581/SDPPI/2019, 63582/SDPPI/2019, 63583/SDPPI/2019, 64639/SDPPI/2019, 64640/SDPPI/2019, 66006/SDPPI/2020, 66074/SDPPI/2020, 67154/SDPPI/2020, 71563/SDPPI/2020,

## Israel

### MoC:

51-41889, 51-42830, 51-42841, 51-43949, 51-46980, 51-54730, 51-55347, 51-63653, 51-69416, 51-69417, 51-73078, 55-02626, 55-06893, 55-06894, 63-63304, 63-66687, 63-66961.

## Jordan

### TRC/LPD/...

2010/91, 2014/9, 2014/186, 2014/214, 2014/241, 2014/248, 2014/258, 2014/274, 2015/387, 2016/252, 2016/353, 2016/538, 2016/584, 2016/591, 2017/63, 2017/254, 2018/1, 2018/162, 2018/381, 2019/152, 2019/153, 2019/155, 2019/227, 2019/233, 2019/234.

TRC/SS/2010/48, TRC/SS/2014/127, TRC/SS/2015/222, TRC/SS/2016/476, TRC/SS/2019/212, TRC/31/7615/2020.

TRC No.: T/4/11/11/...: 3680, 3681, 4387, 4555, 5621, 5649, 5653, 5896, 5898, 9851, 11078.

## Malaysia

CIDF15000490, CIDF15000578, CIDF17000143, MRR14F, ARS4-B, MIB3 OI

RAAT/44A/0219/S(19-0487), RAAU/05C/0415/S(14-3022), RAAU/33C/1015/S(15-0535), RAAU/35C/1115/S(15-0536), RAAU/57A/0111/S(10-2112), RAAU/84A/0618/S(18-2241), RAAU/85A/0618/S(18-2242), RAAU/86A/0618/S(18-2378), RAAU/87A/0718/S(18-2596), RAAU/89A/0718/S(18-3107), RAAU/92A/1218/S(18-4731), RAAU/98A/0620/S(20-2103), RALM/69A/1018/S(18-3829), RDDC/72A/0518/S(18-1697), RDDK/22A/1016/S(16-3306), RDDK/72A/0518/S(18-1697), RDDK/83A/1018/S(18-4152), RDDK/84A/1018/S(18-4153), RFCL/09A/0218/S(18-0609), RFCL/13A/0618/S(18-2379), RFCL/14A/0618/S(18-2543), RFCL/15A/0718/S(18-2544), RFCL/18A/0718/S(18-2529), RFCL/19A/0718/S(18-2545), RFCL/20A/0718/S(18-2718), RFCL/21A/0718/S(18-2717), RFCL/22A/0818/S(18-3109), RFCL/23A/0818/S(18-3153), RFCL/24A/0818/S(18-3152), RFCL/26A/0918/S(18-3810), RFCL/27A/0918/S(18-3812), RFCL/28A/1018/S(18-3977), RFCL/29A/1018/S(18-4127), RFCL/30A/1018/S(18-4129), RFCL/31A/1018/S(18-3976), RFCL/33A/0619/S(19-2422), RFCL/35A/0719/S(19-2874), RFCL/34A/0619/S(19-2421), RFCL/36A/0719/S(19-2875), RFCL/41A/0220/S(20-0390), RFCL/42A/0220/S(20-0391), RFCL/44A/0320/S(20-1385), RGEZ/36A/0521/S(21-2216).

## Morocco

### AGREE PAR L'ANRT MAROC

#### Numéro d'agrément\_Date d'agrément

MR 5835 ANRT 2010, MR 9102 ANRT 2014, MR 11030 ANRT 2015, MR 13576 ANRT 2017,

MR 5611 ANRT 2010\_27.05.2010, MR 7906 ANRT 2013\_06.03.2013, MR 9107 ANRT 2014\_18.03.2014, MR 9741 ANRT 2014\_24.10.2014, MR 9778 ANRT 2014\_11.11.2014, MR 9904 ANRT 2014\_19.12.2014, MR 9918 ANRT 2014\_22.12.2014, MR 11554 ANRT 2016\_15.03.2016, MR 12089 ANRT 2016\_15.06.2016, MR 12123 ANRT 2016\_22.06.2016, MR 12372 ANRT 2016\_16.08.2016, MR 12623 ANRT 2016\_11.10.2016, MR 12901 ANRT 2016\_30.11.2016, MR 13255 ANRT 2017\_09.02.2017, MR 13900 ANRT 2017\_04.05.2017, MR 14830 ANRT 2017\_28.09.2017, MR 15669 ANRT 2018\_31.01.2018, MR 15674 ANRT 2018\_31.01.2018, MR 15675 ANRT 2018\_31.01.2018, MR 16263 ANRT 2018\_06.04.2018, MR 16606 ANRT 2018\_17.05.2018, MR 16657 ANRT 2018\_23.05.2018, MR 16726 ANRT 2018\_30.05.2018, MR 16794 ANRT 2018\_05.06.2018, MR 16860 ANRT 2018\_18.06.2018, MR 16861 ANRT 2018\_18.06.2018, MR 16905 ANRT 2018\_21.06.2018, MR 16906 ANRT 2018\_21.06.2018, MR 16907 ANRT 2018\_21.06.2018, MR 16908 ANRT 2018\_21.06.2018, MR 17015 ANRT 2018\_03.07.2018, MR 17016 ANRT 2018\_03.07.2018, MR 17079 ANRT 2018\_11.07.2018, MR 17080 ANRT 2018\_11.07.2018, MR 17201 ANRT 2018\_06.08.2018, MR 17202 ANRT 2018\_06.08.2018, MR 17203 ANRT 2018\_06.08.2018, MR 17204 ANRT 2018\_06.08.2018, MR 17504 ANRT 2018\_14.09.2018, MR 17505 ANRT 2018\_14.09.2018, MR 17528 ANRT 2018\_19.09.2018, MR 17576 ANRT 2018\_26.09.2018, MR 17678 ANRT 2018\_11.10.2018, MR 17679 ANRT 2018\_11.10.2018, MR 18103 ANRT 2018\_30.11.2018, MR 18334 ANRT 2018\_21.12.2018, MR 18335 ANRT 2018\_21.12.2018, MR 18736 ANRT 2019\_04.02.2019, MR 18928 ANRT 2019\_25.02.2019, MR 19106 ANRT 2019\_14.03.2019, MR 19108 ANRT 2019\_14.03.2019, MR 19315 ANRT 2019\_04.04.2019, MR 19338 ANRT 2019\_09.04.2019, MR 19339 ANRT 2019\_09.04.2019, MR 19767 ANRT 2019\_15.05.2019, MR 19768 ANRT 2019\_15.05.2019, MR 19769 ANRT 2019\_15.05.2019, MR 20859 ANRT 2019\_11.09.2019, MR 20944 ANRT 2019\_19.02.2019, MR 21472 ANRT 2019\_26.11.2019, MR 21473 ANRT 2019\_28.11.2019, MR 21807 ANRT 2019\_23.12.2019, MR 23231 ANRT 2020\_26.05.2020, MR 26081 ANRT 2020\_22.10.2020.

## Mexico

### IFETEL:

IFT/223/UCS/DG-AUSE/0311/2018, IFT-008-2015

RCAPR318-2005, RCPBOFR18-1885, RCPBOLR09-0828, RCPBOLR16-0518, RCPBOMR12-1538, RCPBOMR14-0766, RCPBOMQ19-0594, RCPBOMR14-0922, RCPCOAR18-1800, RCPHAMM10-0514, RCPHEBS14-0180, RCPHEBC18-2099, RCPHEFS19-1702, RCPHEFS20-1469, RCPHERS19-1678, RCPPLGLG16-0952, RCPPLGM19-1163, RCPVIVW20-0478, RCPVOHT13-1485, RCPVOAR15-0015, RCPVWFS16-0693, RCPVWL414-0775, RCPVWL414-0775-A1, RCPVWL617-0023, RCPVWM14-1819, RCPVWM14-1820, RCPVWM15-0640, RCPVWM16-1445, RCPVWM17-1053, RLVBHTS19-1995, RLVCO1820-0821, RLVCOAR15-0008, RLVCOBC16-1823, RLVCOFS18-2029, RLVCOFS18-2030, RLVDER316-1666, RLVDER316-2005, RLVHE0119-0720, RLVHEBC15-0293, RLVHEBC16-0682, RLVHEFS14-1515, RLVHEFS18-1288, RLVHEFS18-1565, RLVHEFS19-1298, RLVHEFS20-0533,

RLVHEFS20-1335, RLVHEFS20-1336, RLVHEFS20-1420, RLVHERS17-0286, RLVHUU19-1065, RLVMBAN18-1512, RLVMBAN18-1512-A1, RLVMBAN18-0363, RLVVFP20-1412, RLVVI-KO18-0155, RLVVIME19-1022, RLVVIME19-1023, RLVVWF17-2122, RLVVWF17-2122-A1, RLVVW1718-1092, RLVVW1718-1169, RLVVW1718-1170, RLVVW1718-1171, RLVVW1718-1314, RLVVW1718-1315, RLVVW1718-1316, RLVVW1718-1317, RLVVW1718-1507, RLVVW1718-1508, RLVVW1718-1509, RLVVW1718-1517, RLVVW1718-1518, RLVVW1718-1519, RLVVW1718-1567, RLVVW1718-1568, RLVVW1718-1789, RLVVW1718-1790, RLVVW1718-1928, RLVVW1718-1929, RLVVW1719-1795, RLVVW1818-1248, RLVVW1818-1249, RLVVW1818-1258, RLVVW1819-0009, RLVVW1819-0023, RTIAU-MI14-1863, RTIWWCO19-1185, RTILGLT19-0483.

La operación de este equipo está sujeta a las siguientes dos condiciones:

- (1) es posible que este equipo o dispositivo no cause interferencia perjudicial y
- (2) este equipo o dispositivo debe aceptar cualquier interferencia, incluyendo la que pueda causar su operación no deseada.

## Mongolia

Монгол Улсад баталгаажсан  
ID: A19000569

## Nigeria

Connection and use of this communications equipment is permitted by the Nigerian Communications Commission.

NCC/TSNi/WN/TA/CERT/: 3137/2019, 3138/2019

## Oman

OMAN TRA/TA:

R/0555/12\_D172338, R/1298-01/10\_D090258, R/1630/13, R/1697/14, R/1733/14\_D080134, R/1743/14\_D090016, R/1995/14, R/2197/14\_D100428, R/2210/14\_D080134, R/2235/14\_D080134, R/2289/14\_D080134, R/2609/15\_D100428, R/2903/15\_D080134, R/3315/16\_D080134, R/3331/16\_D080134, R/3370/16, R/3621/16\_D080134, R/3701/16\_D080134, R/3848/17\_D080134, R/3957/17\_D080134, R/5130/18\_23/01/2018, R/5442/18\_D100428, R/5443/18\_D100428, R/5617/18\_D100428, R/5725/18\_D100428, R/5772/18\_D100428, R/5774/18\_D100428, R/5819/18\_D100428, R/5820/18\_D100428, R/5884/18\_D100428, R/5885/18\_D100428, R/5886/18\_D100428, R/5887/18\_D100428, R/6021/18\_D100428, R/6022/18\_D100428, R/6023/18\_D100428, R/6024/18\_D100428, R/6132/18\_D172249, R/6166/18\_D100428, R/6366/18\_D100428, R/6372/18\_D100428, R/6535/18\_D100428, R/6616/18\_D100428, R/6695/18\_D100428, R/6696/18, R/7145/19\_D172338, R/7240/19\_D100428, R/7244/19\_D100428, R/7383/19\_D100428, R/7384/19\_D100428, R/7604/19\_D100428, R/7481/19\_D172338, R/7704/19, R/7752/19, R/8052/19\_D090024, R/8056/19\_D090024, R/8171/19\_D100428, R/8649/19\_D090024, R/8749/19\_D172338, R/9347/20\_D172338, R/9664/20\_D172338, R/9675/20\_D192564, R/9676/20\_D192564, R/10363/20\_D100428.

TRA/TA/6945/2014\_17/09/2014.

## Pakistan

Pakistan Telecom Authority (TAC No.):

Approved by PTA (2015), Approved by PTA (2016), Approved by PTA (2018), Approved by PTA., 9.1048/2018, 9.160/2021, 9.164/20219.215/2015, 9.245/2020, 9.3012/2018, 9.9112/2019, 9.652/2016, 9.929/2018, 9.93/2021, 9.484/2020, 9.9903/2019.

## Paraguay

CONATEL PY:

216-11-I-000311, 2014-06-I-000122, 2015-02-I-000054, 2016-02-I-0000036, 2016-5-I-000138, 2016-7-I-000174, 2016-7-I-000186, 2016-10-I-000256, 2016-11-I-000293, 2018-05-I-000179, 2018-05-I-000192, 2018-06-I-000212, 2018-07-I-000353, 2018-09-I-000419, 2018-10-I-000480, 2018-10-I-000481, 2018-10-I-000492, 2018-11-I-000612, 2019-01-I-000071, 2019-03-I-000155, 2019-03-I-000156, 2019-05-I-000243, 2019-05-I-000245, 2019-05-I-000253, 2019-06-I-0289, 2019-07-I-0353, 2019-07-I-0396, 2019-08-I-0442, 2019-11-I-0640, 2020-02-I-0111, 2020-02-I-0140, 2020-03-I-00198, 2020-07-I-0417, 2020-11-I-0825, 2020-11-I-0826.

1297/2019, 1298/2019.

Este vehículo posee el siguiente componente de radiofrecuencias, homologado por la CONATEL – Paraguay: Llave Inalámbrica Marca HELLA, Modelo FS19. Fabricado por HELLA Germany.

## Philippines

ESD-1105427C, ESD-1408668C, ESD-1409181C, ESD-1510139C, ESD-1510297C, ESD-1510396C, ESD-1510397C, ESD-1511095C, ESD-1613057C, ESD-1613454C, ESD-1816403C, ESD-1816419C, ESD-1816997C, ESD-1817335C, ESD-1817369C, ESD-1817501C, ESD-1818098C, ESD-1818419C, ESD-1918843C, ESD-1918844C, ESD-1919228C, ESD-1919230C, ESD-1919232C, ESD-1919559C, ESD-1919803C, ESD-1919804C

ESD-GEC-1402882, ESD-CPE-19-20803, ESD-RCE-2023283

## Qatar

CRA/SA/2015/R-4714, CRA/SA/2016/R-5808, CRA/SA/2018/R-6820, CRA/SM/2018/R-7447, CRA/SM/2019/R-8053, CRA/SM/2019/R-8054, CRA/SM/2020/S-0004790

## Zambia

ZMB/ZICTA/TA/...

2016/11/1, 2016/9/21, 2017/9/27, 2018/5/23, 2018/6/20, 2018/8/38, 2018/8/39, 2018/8/40, 2018/8/41, 2018/9/10, 2018/10/10, 2018/10/15, 2018/10/16, 2018/10/17, 2018/10/18, 2018/10/19, 2018/10/20, 2018/10/21, 2018/10/24, 2018/10/25, 2018/10/26, 2018/10/27, 2018/12/16, 2019/2/44, 2019/2/45, 2019/3/23, 2019/3/37, 2019/04/08, 2019/5/13, 2019/6/13, 2019/7/7, 2019/11/47, 2019/11/48, 2020/2/35, 2020/10/51, 2020/10/57, 2021/7/63.

## Serbia

P1617197200, P1619073700, P1619073800, P1619095800, P1620069300, P1620151500, P1620169600, 34540-768/18-5, 34540-1313/16-3.

W005 12, W005 13, W005 14, W005 15, W005 16, W005 17, W005 18, W005 19, W005 19, W005 20, W011 13, W011 13-4, W011 14, W011 15, W011 17, W011 18, W011 19

## Singapore

Complies with IMDA Standards:

103238, DA103787, DA103858, DA104328, DA104682, DA104682 (N0688-15), DA104812, DA105282, DA107248, DA107974  
DB103858, DB106879, DB106879 (N3083-18), DB107220.

Complies with IDA Standards:

G1594-19, N0721-15, N1599-19, N2152-20, N2404-19, N2405-19, N2860-16, N3688-18, N4975-17.

## South Africa

ICASA APPROVED:

TA-2005/614, TA-2009/464, TA-2010/218, TA-2010/1235, TA-2012/1747, TA-2012/1821, TA-2013/2085, TA-2013/2465, TA-2013/2503, TA-2014/176, TA-2014/212, TA-2014/1719, TA-2014/1783, TA-2014/1887, TA-2014/2108, TA-2014/2597, TA-2015/517, TA-2015/2011, TA-2015/2084, TA-2016/169, TA-2016/501, TA-2016/820, TA-2016/863, TA-2016/1449, TA-2016/2568, TA-2016/2601, TA-2016/2759, TA-2016/3407, TA-2016/3539, TA-2017/2824, TA-2018/175, TA-2018/280, TA-2018/732, TA-2018/998, TA-2018/1205, TA-2018/2868, TA-2018/3141, TA-2018/3466, TA-2018/3974, TA-2018/5159, TA-2019/115, TA-2019/348, TA-2019/582, TA-2019/583, TA-2019/1853, TA-2019/5101, TA-2019/5116, TA-2019/5167, TA-2020/4885, TA-2020/5217, TA-2020/5480, TA-2020/6392, TA-2020/7390, TA-2021/0637.

## Thailand

Class A NBTC ID: 5700619-XXXX, A57004-17-xxxx, A57008-14-xxxx, A57019-16-xxxx, RT 1751, RT 1752, 255.A.2560, FPK8IMM05D, MRRe14FCR.

Class B NBTC ID: B38038-20-1814, B38166-20-1814.

- 1) เครื่องโทรคมนาคมและอุปกรณ์นี้ มีความสอดคล้องตามมาตรฐานหรือข้อกำหนดของ กสทช.
- 2) เครื่องวิทยุคมนาคมนี้ มีระดับการแผ่คลื่นแม่เหล็กไฟฟ้า สอดคล้องตามมาตรฐานความปลอดภัยต่อสุขภาพของมนุษย์-จากการใช้เครื่องวิทยุคมนาคมที่คณะกรรมการกิจการโทรคมนาคมแห่งชาติประกาศกำหนด

## Turkey

For declarations of conformity, see [www.volkswagen.com/generalinfo](http://www.volkswagen.com/generalinfo).

Further information on radio systems → page 373

## Countries outside the US, which approve and permit radio systems in accordance with US FCC guidelines:

FCC ID: 2A0UZ17101001	FCC ID: 2A0UZ17101002
FCC ID: 2A0UZ17101010	FCC ID: 2A0UZ17101022
FCC ID: 2A0UZ17101023	FCC ID: 2A0UZ17101031
FCC ID: 2A0UZ17101032	FCC ID: 2A0UZ17101033
FCC ID: 2A0UZ17101034	FCC ID: 2A0UZ17101041
FCC ID: 2A0UZ17101042	FCC ID: 2A0UZ17101043

FCC ID: 2A0UZ17101051  
FCC ID: 2A0UZ17101053  
FCC ID: 2A0UZ17101055  
FCC ID: 2A0UZ17101057  
FCC ID: 2A0UZ17101072  
FCC ID: 2A0UZ18020532  
FCC ID: 2A0UZ18020534  
FCC ID: 2AVXWWSBRC001

FCC ID: 2AAJCBR20  
FCC ID: 2AA98A  
FCC ID: 2AA98-MEDIUM5C  
FCC ID: 2APOM-MQBA0  
FCC ID: BEJLCW05-VWES  
FCC ID: BEJMIB2  
FCC ID: BEJ-MEBICAS3  
FCC ID: BEJ-MIB30I  
FCC ID: BEJTUVM01IU  
FCC ID: CWTUGZZF1  
FCC ID: IYZVK2  
FCC ID: KR5FS14T  
FCC ID: LTRQ3TR  
FCC ID: T8GA475  
FCC ID: NBG010180T  
FCC ID: NBG013854  
FCC ID: NBGBCMEVO  
FCC ID: NBGBCM2R  
FCC ID: NBGFS12PM  
FCC ID: NBGFS125C  
FCC ID: NBGFS125C5  
FCC ID: NBGFS173NPM  
FCC ID: NBGFS1744M  
FCC ID: NBGFS191  
FCC ID: NBGMQBBS  
FCC ID: NBGRS819  
FCC ID: NF3-LRR3SCU  
FCC ID: NF3-MRR1PLUS  
FCC ID: NF3MRRREVO14F  
FCC ID: NT8-FPK8IMM05D  
FCC ID: NZLADHLS5D  
FCC ID: OAYARS5B  
FCC ID: OYGTSSRE4UF  
FCC ID: QIPALAS6A-US  
FCC ID: RK7MBC-NAR  
FCC ID: RX2BNFHL  
FCC ID: VPYLB1KD  
FCC ID: KR55NA920791A

FCC ID: 2A0UZ17101052  
FCC ID: 2A0UZ17101054  
FCC ID: 2A0UZ17101056  
FCC ID: 2A0UZ17101071  
FCC ID: 2A0UZ18020531  
FCC ID: 2A0UZ18020533  
FCC ID: 2A0UZ18100931

FCC ID: 2AA98  
FCC ID: 2AA98-COLOUR5C  
FCC ID: 2AHPN-WLC  
FCC ID: 772C-LB1FD  
FCC ID: NF3-FR5CPEC  
FCC ID: BEJMIB2PQ  
FCC ID: BEJ-MIBPQMIN  
FCC ID: BEJTLVM3IU-N  
FCC ID: BEJTLVHW3IU-E  
FCC ID: CWTUGZZF2  
FCC ID: KR5-BCMEVOC  
FCC ID: KR5FS14TK  
FCC ID: T8GA270  
FCC ID: T8GA476  
FCC ID: NBG011719A  
FCC ID: NBG01R54  
FCC ID: NBGBCMEV05  
FCC ID: NBGFS09P03  
FCC ID: NBGFS12P01M  
FCC ID: NBGFS125C1  
FCC ID: NBGFS173NP  
FCC ID: NBGFS173NR  
FCC ID: NBGFS19  
FCC ID: NBGFS93N  
FCC ID: NBGMQBBS  
FCC ID: NBG011719A  
FCC ID: NF3-LRR4  
FCC ID: NF3-MRR1REAR  
FCC ID: NF3-LRR3SCU  
FCC ID: NT8-VVMIBREGIO  
FCC ID: OAYARS4B  
FCC ID: OYGTSSRE4UD  
FCC ID: OYGTSSSG4G5  
FCC ID: QZ9-KA3  
FCC ID: RK7185-00  
FCC ID: RX2BNFLL  
FCC ID: WJLHT-5

## Interference statement

This device complies with part 15 of the FCC Rules. Operation is subject to the following two conditions:

- (1) This device may not cause harmful interference, and
- (2) This device must accept any interference received, including interference that may cause undesired operation.

**CAUTION TO USERS:** Changes or modifications not expressly approved by the party responsible for compliance could void the user's authority to operate the equipment.

#### Wireless notice

This device complies with FCC radiation exposure limits set forth for an uncontrolled environment and meets the FCC radio frequency (RF) Exposure Guidelines. This transmitter must not be colocated or operating in conjunction with any other antenna or transmitter. The antenna should be installed and operated with minimum distance of 20 cm between the radiator and your body.

#### FCC Class A digital device notice

This equipment has been tested and found to comply with the limits for a Class B digital device, pursuant to Part 15 (and to Part 18) of the FCC Rules. These limits are designed to provide reasonable protection against harmful interference in a residential installation. This equipment generates, uses and can radiate radio frequency energy and, if not installed and used in accordance with the instructions, may cause harmful interference to radio communications. However, there is no guarantee that interference will not occur in a particular installation.

#### FCC Class B digital device notice

**NOTE:** This equipment has been tested and found to comply with the limits for a Class B digital device, pursuant to Part 15 of the FCC Rules. These limits are designed to provide reasonable protection against harmful interference in a residential installation. This equipment generates, uses and can radiate radio frequency energy and, if not installed and used in accordance with the instructions, may cause harmful interference to radio communications. However, there is no guarantee that interference will not occur in a particular installation. If this equipment does cause harmful interference to radio or television reception, which can be determined by turning the equipment off and on, the user is encouraged to try to correct the interference by one or more of the following measures:

- Reorient or relocate the receiving antenna.
- Increase the separation between the equipment and receiver.
- Connect the equipment into an outlet on a circuit different from that to which the receiver is connected.
- Consult the dealer or an experienced radio/TV technician for help.

#### Ukraine

For declarations of conformity, see [www.volkswagen.com/generalinfo](http://www.volkswagen.com/generalinfo).

Further information on radio systems → page 373

BSD 3.0	24,05 - 24,25 GHz	20 dBm
LCA 2.0	24,05 - 24,25 GHz	20 dBm
RS4	24,05 - 24,25 GHz	20 dBm

повний текст декларації про відповідність доступний на веб-сайті за такою адресою: [www.volkswagen.com/generalinfo](http://www.volkswagen.com/generalinfo).

1APTVR3TR, 1BOSCO001, 1HELARS40, 10094.007280-19, 1.001.021241-20-TE, 0848, TLAHW3IU-E, TLVHM3IU-E, TLVLM3IU-E, TLAHW3IU-W, TLVHM3IU-W

1.001.017067-18-TE, 1.001.018566-19-TE, 1.001.018601-19-TE, 1.001.018646-19-TE, 1.001.019275-19-TE, 1.001.019287-19-TE, 1.001.020220-19-TE, 1.001.020355-19-TE, 1.001.020702-19-TE, 1.001.020853-19-TE, 1.001.020929-19-TE, 1.001.021241-20-TE, 1.001.021295-20-TE, 1.001.022108-20-TE

UA.R.TR.052.081-20, UA.R.TR.052.088-19, UA.R.TR.052.089-19, UA.R.TR.052.161-19, UA.R.TR.052.187-19, UA.R.TR.052.189-19, UA.R.TR.052.190-19, UA.R.TR.052.194-19, UA.R.TR.052.598-19, UA.R.TR.052.613-19

UA.TR.028: 680.13-CET, 680.14-CET, 680.15-CET, 2423.21-CET, 2423.31-CET, 2423.32-CET, 2423.33-CET, 2423.44-CET, 2423.49-CET, 2423.50-CET, 2423.51-CET, 2539.9-CET, 2539.10-CET, 2539.12-CET, 2539.13-CET, 2539.15-CET, 2539.17-CET, 2539.19-CET, 2539.20-CET, 2539.21-CET, 2539.22-CET, 2539.23-CET, 2539.30-CET, 2539.31-CET, 2580.4-CET, 2580.5-CET, 2610.2-CET

UA.TR.030.026039-19, UA.TR.030.028039-19, UA.TR.109.R.0009-18, UA.TR.109.R.0016-19, UA.TR.109.R.0021-19, UA.TR.109.R.0026-19, UA.TR.109.R.0029-19, UA.TR.109.R.0030-19, UA.TR.109.R.0032-19, UA.TR.109.R.0082-20, UA.TR.109.R.0133-19, UA.TR.109.R.0155-18, UA.TR.109.R.0162-19, UA.TR.109.R.0168-19, UA.TR.109.R.0179-18, UA.TR.109.R.0187-18, UA.TR.109.R.0201-19, UA.TR.109.R.0212-19, UA.TR.109.R.0214-18, UA.TR.109.R.0249-18, UA.TR.109.R.0259-18, UA.TR.109.R.0281-18, UA.TR.109.R.0282-18, UA.TR.109.R.0304-18, UA.TR.109.R.0305-18, UA.TR.109.R.0307-18, UA.TR.109.R.0336-19, UA.TR.109.R.0337-19, UA.TR.109.R.0344-18, UA.TR.109.R.0345-18, UA.TR.109.R.0375-18, UA.TR.109.R.0389-18, UA.TR.109.R.0394-18, UA.TR.109.R.0411-18, UA.TR.109.R.0425-18, UA.TR.109.R.0438-18, UA.TR.109.R.0467-18, UA.TR.109.R.0598-18

UA RF: 1BOSCO001, UA RF: 1CONTO001, UA RF: 1CONTO002, UA RF: 1HELARSD3, UA RF: 1HELARS40

UA.032.CT.0026-19, UA.032.CT.0030-18, UA.032.CT.0083-19, UA.032.CT.0084-19, UA.032.CT.0107-19, UA.032.CT.0188-18, UA.032.CT.0221-20, UA.032.CT.0224-19, UA.032.CT.0225-19, UA.032.CT.0226-19, UA.032.CT.0227-19, UA.032.CT.0313-19, UA.032.CT.0527-19

920697B

#### United Arab Emirates

TRA, REGISTERED No\_DEALER No

ER0029197/10\_DA0014517/08, ER0109760/13\_DA0043253/10, ER0126849/14\_DA0127935/14, ER34947/14\_DA0043252/10, ER35080/14\_DA0028019/10, ER35423/14\_DA35176/14, ER37557/15\_DA0028019/10, ER37807/15\_DA38660/15, ER40510/15\_DA44932, ER40885/15\_DA44877/15,

ER42982/15\_DA36758/14, ER45520/16\_DA44932,  
ER46672/16\_DA38660/15, ER47887/16\_DA28019/10,  
ER48223\_DA44932, ER49378/16\_DA38660/15,  
ER49719/16\_DA0062437/11, ER49796/16\_DA35176/14, ER50430/16,  
ER51643/17, ER53878/17\_DA44932/15, ER54754/17\_DA0043253/10,  
ER55421/17\_DA36758/14, ER61136/18\_DA40068,  
ER61137/18\_DA0089862/12, ER62570\_DA44932, ER63911\_DA44932,  
ER66801/18\_DA77281/18, ER66978/18\_DA36758/14,  
ER68006/18\_DA40068/15, ER68096/18\_DA36975/14,  
ER68097/18\_DA36975/14, ER69987/19\_DA44932/15,  
ER70009/19\_DA44932, ER70046/19\_DA44932,  
ER70554/19\_DA0043253/10, ER70659/19\_DA44932,  
ER70659/19\_DA44932/15, ER71148/19\_DA0043253/10,  
ER71355/19\_DA38660/15, ER71413/19\_DA0089862/12, ER71414/19,  
ER73393/19, ER74095/19, ER75266/19\_DA0086237/12,  
ER76324/19\_DA56674/16, ER77956/20\_DA76153/18, ER81399/20,  
ER88450/20\_DA0086237/12, ER89638/20\_DA36975/14,  
ER90294/20\_DA0043253/10.

#### **Vietnam**

A0406070421AF04A3, A0407070421AF04A3, A0858170820AF04A3,  
B1189140520AF04A2, B2110171214BE11A2, C00082015,  
C0032060315BE01A2, C0080180319AF04A2, C0092300320AF04A2,  
C010121051BAF04A2, C0101230419AF04A2, C0118220519AF04A2,  
C0119220519AF04A2, C0163150719AF04A2, C0197111217AF04A2,  
C0314061219AF04A2, , C0438061120AF04A3

#### **Belarus**

BY/1112 11.01....

TP024 020 00007, TP024 020 00008, TP024 020 00047,  
TP024 020 00059, TP024 030 00140, TP024 020 00687,  
TP024 020 00716,

Ra.RU.21WP01.



# Technical data

## Notes on technical data

### General information on the data

Except where indicated or specifically stated, the technical data applies to the basic model. The figures may be different if additional equipment is fitted and in the case of different model versions, special vehicles and vehicles for other countries. All data in the official vehicle documents always takes precedence.

The official vehicle documents show which drive and which power output your vehicle has.

Please observe the notes and information for vehicles with N1 approval → page 372, *Information about vehicles with N1 approval (light commercial vehicle)*.

#### Weight

The values for the kerb weight in the following tables apply to the road-ready vehicle (country-dependent):

- with driver (75 kg (165 lbs)), service fluids including fuel tank carrying 90% of its capacity.
- without the driver, with service fluids including fuel tank carrying 90% of its capacity plus excess load consisting of optional equipment.

Additional equipment and retrofitted accessories increase the stated kerb weight and reduce the maximum permitted load accordingly.

The load comprises the weights of the following:

- Passengers
- All luggage inside and outside of the vehicle.
- Add-on parts.
- Drawbar load when towing a trailer.

The permitted gross vehicle weight rating and gross axle weight rating must never be exceeded. The permitted values are provided on the safety certificate

(“safety compliance label”) on the B-pillar on the driver side → page 390 → page 390.

#### Performance figures

The performance figures were measured without equipment which may detrimentally affect performance, such as add-on parts.

The power output and performance figures may differ for reasons of vehicle registration or vehicle taxation.

The maximum speed may be limited and may therefore be lower for some engine versions in vehicles equipped with heavy-duty running gear.

#### Maximum trailer weight and drawbar load values

The figures for maximum trailer weight and drawbar load that are given on the type plate of the towing bracket are for certification purposes of the towing bracket only. The correct values for your specific model, which are often lower than these figures, are given in the vehicle documents. The values in the official vehicle documents, on the type plate of the vehicle → page 390 or on the safety certificate → page 390 always have priority.

#### Gross combination weight

The gross combination weight ratings listed apply only to altitudes up to 1,000 m (3000 ft) above sea level. The maximum gross combination weight rating must be reduced by approximately 10% for every further started 1,000 m (3000 ft) in altitude.

#### Gradient angle

The gradient angle is an indication of the vehicle's gradeability and corresponds to the gradient that the vehicle can drive up under its own power. This depends on aspects such as the road surface, weather conditions and engine power. The values apply to a moving vehicle and not to driving off from standstill.

The number of metres in height gained over a distance of 100 m (300 ft) (gradient) will be given as a percentage or degree value (100% = 45 degrees). <

## Vehicle identification number

### Structure of the vehicle identification number

The vehicle identification number VIN comprises 17 characters. These characters are categorised into seven groups.

The basic structure is explained below using the example of the vehicle identification number WVWZZZCBZLE400953. This is an example.

Group	①	②	③	④	⑤	⑥	⑦										
Position:	1	2	3	4	5	6	7	8	9	10	11	12	13	14	15	16	17

Group	①		②			③		④	⑤	⑥	⑦						
Example	W	V	W	Z	Z	Z	C	B	Z	M	E	4	0	0	9	5	3

① Vehicle manufacturer identifier:

- WVW** Volkswagen Passenger Cars
- WVG** Volkswagen Passenger Cars
- 1VW** Volkswagen Group of America Inc., Volkswagen de México, S.A. de C.V
- 3VW** Volkswagen de México, S.A. de C.V
- XWB** LLC Volkswagen Group Rus (Volkswagen/ Skoda Kaluga)
- MFB** Garuda Matraman Motor (Indonesia)

② Filler characters: the filler characters may differ depending on manufacturer or contain information about the body or gearbox type.

③ Vehicle class per model:

- 3H** Arteon
- 5T** Touran
- 6R** Polo
- AC** T-Roc Cabriolet
- BV** Golf
- CB** Passat
- CA** Atlas
- CR** Touareg

Depending on manufacturer, the places 7 to 9 can also contain information on the fuel type (7) and vehicle class (8 and 9).

④ Filler or check character: the filler characters may differ depending on manufacturer.

⑤ VIN index per model year:

- M** 2021
- N** 2022
- P** 2023
- R** 2024

⑥ Production location, manufacturing plant:

- C** Volkswagen Chattanooga Plant
- D** Volkswagen Bratislava Plant
- E** Volkswagen Emden Plant
- K** Volkswagen Osnabrück Plant
- Or:** Volkswagen Kaluga Plant
- M** Volkswagen Puebla Plant
- P** Volkswagen Zwickau Plant
- T** Volkswagen Pune Plant
- U** Volkswagen Uitenhage Plant

- V** Volkswagen Palmela Plant
- W** Volkswagen Wolfsburg Plant
- Y** Volkswagen Pamplona Plant

The letters assigned to the production locations may differ on a vehicle-specific basis or may have a double assignment.

⑦ Sequential production number in a model year.

#### Position of the vehicle identification number



**Fig. 263** In the windscreen: vehicle identification number.

The vehicle identification number can be read from outside the vehicle through a viewer in the windscreen. The viewer is located in the lower corner of the windscreen.

For some models, depending on the Infotainment system version, the vehicle identification number can be displayed in the Service menu or in the vehicle settings. The vehicle identification number can also be found on the type plate.

Depending on model, market and engine, the vehicle identification number may also be stamped at one of the following locations:

- In the engine compartment in the right water drainage channel.
- In the engine compartment on the right suspension turret.
- In the engine compartment close to the bonnet hinge on the right side of the vehicle.
- Behind the right front seat under the floor covering.

## Type plate

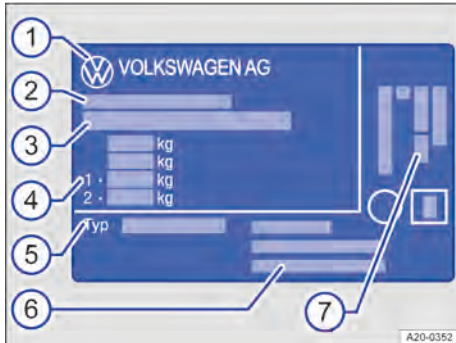

Fig. 264 Type plate (illustration): variant 1.

Depending on country, the number of the type approval, e.g. EC type approval number, may be specified.

- ① Manufacturer code.
- ② Type approval.
- ③ Vehicle identification number.
- ④ Gross vehicle weight rating.

Gross combination weight rating (vehicle plus trailer).

Gross front axle weight rating.

Gross rear axle weight rating.

- ⑤ Vehicle type.
- ⑥ Manufacturer's address.
- ⑦ Engine code.

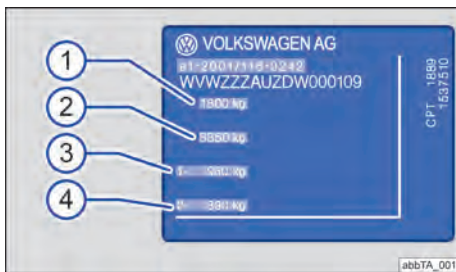

Fig. 265 Type plate (illustration): variant 2.

Depending on country, the number of the type approval, e.g. EC type approval number, may be specified.

- ① Gross vehicle weight rating.
- ② Gross combination weight rating (vehicle plus trailer).
- ③ Gross front axle weight rating.
- ④ Gross rear axle weight rating.

Depending on country and model, the type plate is visible in the lower area of the door pillar after opening the driver or front passenger door. Vehicles for certain export countries do not have a type plate. <

## Safety certificate



Fig. 266 Safety certificate (illustration).

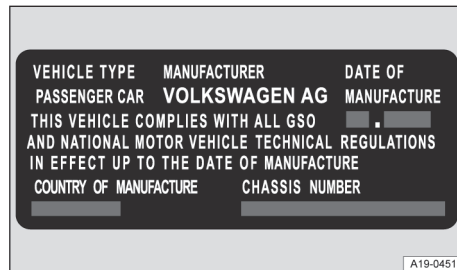

Fig. 267 Safety certificate (illustration).

A safety certificate on the door pillar in the driver door shows the following information:

- Vehicle type.
- Manufacturer.
- Date of manufacture.
- Country of manufacture.
- Vehicle identification number. <



## Dimensions

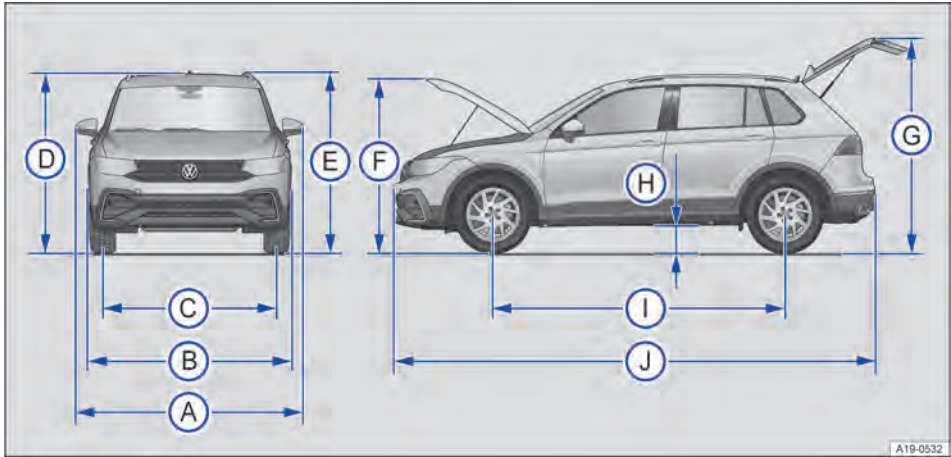

Fig. 268 Vehicle dimensions.

The data in the table applies to the German basic model with the basic specification.

The specified values can vary due to different wheel rim and tyre sizes, additional equipment, different model versions or retrofitted accessories, and also

for special vehicles and vehicles that have been manufactured for other countries.

Information on the composition of the weights can be found in section → page 388.

### Tiguan front-wheel drive, Tiguan all-wheel drive

Key to Fig. 268:		Front-wheel drive	All-wheel drive
(A)	Width from one exterior mirror to the other	mm 2099	2099
(B)	Width	mm 1839	1839
	R-Line width with wheel housing extension	mm 1859	1859
(C)	Front track	mm 1579 – 1589	1576 – 1586
	Rear track	mm 1569 – 1579	1566 – 1576
(D)	Height to the upper edge of the roof at kerb weight	mm 1635	1645
	Height at kerb weight with GPS aerial	mm 1674	1684
(E)	Height to the roof railing at kerb weight	mm 1649	1659
(F)	Height with open bonnet at kerb weight	mm 1803	1813
(G)	Height with open boot lid at kerb weight	mm 2089	2099
(H)	Ground clearance between the axles at kerb weight	mm 191	201
(I)	Wheelbase at kerb weight	mm 2681	2681
	- Turning circle diameter	m 11.5	11.5
(J)	Length with standard and off-road front from bumper to bumper	mm 4509	4509
	R-Line length from bumper to bumper	mm 4511	4511
	Length with standard and off-road front with factory-fitted towing bracket	mm 4628	4628
(J)	R-Line length with factory-fitted towing bracket	mm 4630	4630

## Tiguan R

Key to Fig. 268:			
(A)	Width from one exterior mirror to the other	mm	2099
(B)	Width	mm	1859
(C)	Front track	mm	1579 – 1589
	Rear track	mm	1570 – 1580
(D)	Height to the upper edge of the roof at kerb weight	mm	1638
	Height at kerb weight with GPS aerial	mm	1677
(E)	Height to the roof railing at kerb weight	mm	1652
(F)	Height with open bonnet at kerb weight	mm	1804
(G)	Height with open boot lid at kerb weight	mm	2092
(H)	Ground clearance between the axles at kerb weight	mm	195
(I)	Wheelbase at kerb weight	mm	2681
-	Turning circle diameter	m	11.5
(J)	Length with standard and off-road front from bumper to bumper	mm	4514
(J)	Length with standard and off-road front with factory-fitted towing bracket	mm	4634

## Tank capacities

The fuel tank has the following capacity:

- approx. 60 l
- approx. 63 l in vehicles with all-wheel drive



The fuel tank capacity includes an undefined reserve quantity which remains in the tank when the fuel gauge indicates an empty tank. The reserve quantity is variable and cannot be reliably used to increase the remaining range.

## Petrol engines

### 1.4 l, 4-cylinder TSI<sup>®</sup>, 92 kW, petrol engine

#### Engine overview

Power output	kW	92 at 5000 – 6000 rpm
Engine code		CZDB
Maximum torque	Nm	220 at 1500 – 4000 rpm
Gearbox		MG6
Maximum speed	km/h	– <sup>a)</sup>

<sup>a)</sup> Figures were not available at time of publication.

#### Weights and axle loads

Kerb weight with driver → page 388	kg	1533
Kerb weight without driver → page 388	kg	1458
Gross vehicle weight rating	kg	2040
Gross front axle weight rating	kg	1050
Gross rear axle weight rating	kg	1070

### Maximum trailer weights

Maximum trailer weight braked, gradients up to 12 %	kg	1600
Maximum trailer weight braked, gradients up to 8 %	kg	1800
Maximum trailer weight unbraked	kg	750
Maximum permitted gross combination weight	kg	3640
Maximum permissible drawbar load	kg	100
Load capacity for rear carrier systems → page 280, <i>Fitting a rear carrier system or bicycle carrier on the towbar</i>		

## 1.5 l, 4-cylinder TSI®, 96 kW, ACT, petrol engine

### Engine overview

Power output	kW	96 at 5000 – 6000 rpm
Engine code		DPBE
Maximum torque	Nm	220 at 1750 – 3500 rpm
Gearbox		MG6
Maximum speed	km/h	195

### Weights and axle loads

Kerb weight with driver → page 388	kg	1504
Kerb weight without driver → page 388	kg	1429
Gross vehicle weight rating	kg	2090
Gross front axle weight rating	kg	1050
Gross rear axle weight rating	kg	1090

### Maximum trailer weights

Maximum trailer weight braked, gradients up to 12 %	kg	1600
Maximum trailer weight braked, gradients up to 8 %	kg	1800
Maximum trailer weight unbraked	kg	750
Maximum permitted gross combination weight	kg	3570 – 3690
Maximum permissible drawbar load	kg	100
Load capacity for rear carrier systems → page 280, <i>Fitting a rear carrier system or bicycle carrier on the towbar</i>		

## 1.4 l, 4-cylinder TSI®, 110 kW, petrol engine

### Engine overview

Power output	kW	110 at 5000 – 6000 rpm
Engine code		CZDA
Maximum torque	Nm	250 at 1500 – 3500 rpm
Gearbox		MG6
Maximum speed	km/h	200

### Weights and axle loads

Kerb weight with driver → page 388	kg	1520
Kerb weight without driver → page 388	kg	1445
Gross vehicle weight rating	kg	2100
Gross front axle weight rating	kg	1060
Gross rear axle weight rating	kg	1090

### Maximum trailer weights

Maximum trailer weight braked, gra- dients up to 12 %	kg	1800
Maximum trailer weight braked, gra- dients up to 8 %	kg	2000
Maximum trailer weight unbraked	kg	750
Maximum permitted gross combina- tion weight	kg	3900
Maximum permissible drawbar load	kg	200
Load capacity for rear carrier systems → page 280, <i>Fitting a rear carrier system or bicycle carrier on the tow- bar</i>		

## 1.5 l, 4-cylinder TSI®, 110 kW, petrol engine

### Engine overview

Power output	kW	110 at 5000 – 6000 rpm	
Engine code		DXDB	
Maximum torque	Nm	220 at 1500 – 4000 rpm	
Gearbox		MG6	DSG® 7
Maximum speed	km/h	– a)	– a)

a) Figures were not available at time of publication.

### Weights and axle loads

Gearbox		MG6	DSG® 7
Kerb weight with driver → page 388	kg	– a)	– a)
Kerb weight without driver → page 388	kg	1427	1461
Gross vehicle weight rating	kg	1970 – 2090	2000 – 2120
Gross front axle weight rating	kg	1050	1080
Gross rear axle weight rating	kg	1090	1090

a) Figures were not available at time of publication.

### Maximum trailer weights

Gearbox		MG6	DSG® 7
Maximum trailer weight braked, gra- dients up to 12 %	kg	1800	1800
Maximum trailer weight braked, gra- dients up to 8 %	kg	1900 – 2000	2000
Maximum trailer weight unbraked	kg	750	750
Maximum permitted gross combina- tion weight	kg	3800 – 3895	3840 – 3940
Maximum permissible drawbar load	kg	100	100

Load for rear carrier systems → page 280, *Fitting a rear carrier system or bicycle carrier on the tow-bar*

## 1.5 l, 4-cylinder TSI®, 110 kW, ACT, petrol engine

### Engine overview

Power output	kW	110 at 5000 – 6000 rpm	
Engine code		DPCA	
Maximum torque	Nm	250 at 1500 – 3500 rpm	
Gearbox		MG6	DSG®7
Maximum speed	km/h	202 – 203	202

### Weights and axle loads

Gearbox		MG6	DSG®7
Kerb weight with driver → page 388	kg	1502	1536
Kerb weight without driver → page 388	kg	1427	1461
Gross vehicle weight rating	kg	1970 – 2090	2000 – 2120
Gross front axle weight rating	kg	1050	1080
Gross rear axle weight rating	kg	1090	1090

### Maximum trailer weights

Gearbox		MG6	DSG®7
Maximum trailer weight braked, gra- dients up to 12 %	kg	1800	1800
Maximum trailer weight braked, gra- dients up to 8 %	kg	1900 – 2000	2000
Maximum trailer weight unbraked	kg	750	750
Maximum permitted gross combina- tion weight	kg	3770 – 3890	3800 – 3920
Maximum permissible drawbar load	kg	100	100

Load capacity for rear carrier systems → page 280, *Fitting a rear carrier system or bicycle carrier on the tow-bar*

## 2.0 l, 4-cylinder TSI®, 132 kW, petrol engine

### Engine overview

Power output	kW	132 at 3900 – 6000 rpm	
Engine code		CZPA	
Maximum torque	Nm	320 at 1400 – 3940 rpm	
Gearbox		DSG®7	
Maximum speed	km/h	210	

### Weights and axle loads

Kerb weight with driver → page 388	kg	1692	
Kerb weight without driver → page 388	kg	1617	
Gross vehicle weight rating	kg	2190 – 2260	
Gross front axle weight rating	kg	1160	

Gross rear axle weight rating	kg	1150
-------------------------------	----	------

#### Maximum trailer weights

Maximum trailer weight braked, gradients up to 12 %	kg	2100 – 2200
Maximum trailer weight braked, gradients up to 8 %	kg	2100 – 2200
Maximum trailer weight unbraked	kg	750
Maximum permitted gross combination weight	kg	4290 – 4480
Maximum permissible drawbar load	kg	100
Load capacity for rear carrier systems → page 280, <i>Fitting a rear carrier system or bicycle carrier on the towbar</i>		

## 2.0 l, 4-cylinder TSI<sup>®</sup>, 140 kW, petrol engine

#### Engine overview

Power output	kW	140 at 4200 – 6000 rpm
Engine code		DNNA
Maximum torque	Nm	140 at 4200 – 6000 rpm
Gearbox		DSG <sup>®</sup> 7
Maximum speed	km/h	214

#### Weights and axle loads

Kerb weight with driver → page 388	kg	1676
Kerb weight without driver → page 388	kg	1601
Gross vehicle weight rating	kg	2190 – 2250
Gross front axle weight rating	kg	1160
Gross rear axle weight rating	kg	1140

#### Maximum trailer weights

Maximum trailer weight braked, gradients up to 12 %	kg	2100 – 2200
Maximum trailer weight braked, gradients up to 8 %	kg	2100 – 2200
Maximum trailer weight unbraked	kg	750
Maximum permitted gross combination weight	kg	4290 – 4450
Maximum permissible drawbar load	kg	100
Load capacity for rear carrier systems → page 280, <i>Fitting a rear carrier system or bicycle carrier on the towbar</i>		

## 2.0 l, 4-cylinder TSI<sup>®</sup>, 140 kW, petrol engine

#### Engine overview

Power output	kW	140 at 4100 – 6000 rpm
Engine code		DKZA
Maximum torque	Nm	320 at 1500 – 4200 rpm

Gearbox		DSG®7
Maximum speed	km/h	- a)

a) Figures were not available at time of publication.

#### Weights and axle loads

Kerb weight with driver → page 388	kg	1723
Kerb weight without driver → page 388	kg	1648
Gross vehicle weight rating	kg	2210 – 2230
Gross front axle weight rating	kg	1140
Gross rear axle weight rating	kg	1140

#### Maximum trailer weights

Maximum trailer weight braked, gradients up to 12 %	kg	2200
Maximum trailer weight braked, gradients up to 8 %	kg	2200
Maximum trailer weight unbraked	kg	750
Maximum permitted gross combination weight	kg	4410 – 4430
Maximum permissible drawbar load	kg	100
Load capacity for rear carrier systems → page 280, <i>Fitting a rear carrier system or bicycle carrier on the towbar</i>		

## 2.0 l, 4-cylinder TSI®, 162 kW, petrol engine

#### Engine overview

Power output	kW	162 at 4500 – 6200 rpm
Engine code		CHHB
Maximum torque	Nm	350 at 1500 – 4400 rpm
Gearbox		DSG®7
Maximum speed	km/h	225

#### Weights and axle loads

Kerb weight with driver → page 388	kg	1699
Kerb weight without driver → page 388	kg	1624
Gross vehicle weight rating	kg	2190 – 2260
Gross front axle weight rating	kg	1160
Gross rear axle weight rating	kg	1150

#### Maximum trailer weights

Maximum trailer weight braked, gradients up to 12 %	kg	2100 – 2200
Maximum trailer weight braked, gradients up to 8 %	kg	2100 – 2200
Maximum trailer weight unbraked	kg	750
Maximum permitted gross combination weight	kg	4290 – 4460
Maximum permissible drawbar load	kg	100

Load capacity for rear carrier systems → page 280, *Fitting a rear carrier system or bicycle carrier on the tow-bar* ◀

## 2.0 l, 4-cylinder TSI<sup>®</sup>, 180 kW, petrol engine

### Engine overview

Power output	kW	180 at 5250 – 6500 rpm
Engine code		DNPA
Maximum torque	Nm	370 at 1600 – 4300 rpm
Gearbox		DSG <sup>®</sup> 7
Maximum speed	km/h	229

### Weights and axle loads

Kerb weight with driver → page 388	kg	1688
Kerb weight without driver → page 388	kg	1613
Gross vehicle weight rating	kg	2190 – 2270
Gross front axle weight rating	kg	1160
Gross rear axle weight rating	kg	1160

### Maximum trailer weights

Maximum trailer weight braked, gradients up to 12 %	kg	2100 – 2200
Maximum trailer weight braked, gradients up to 8 %	kg	2100 – 2200
Maximum trailer weight unbraked	kg	750
Maximum permitted gross combination weight	kg	4290 – 4470
Maximum permissible drawbar load	kg	100

Load capacity for rear carrier systems → page 280, *Fitting a rear carrier system or bicycle carrier on the tow-bar* ◀

## 2.0 l, 4-cylinder TSI<sup>®</sup>, 235 kW, petrol engine

### Engine overview

Power output	kW	235 at 5600 – 6500 rpm
Engine code		DSFE
Maximum torque	Nm	400 at 2000 – 5600 rpm
Gearbox		DSG <sup>®</sup> 7
Maximum speed	km/h	– <sup>a)</sup>

<sup>a)</sup> Figures were not available at time of publication.

### Weights and axle loads

Kerb weight with driver → page 388	kg	1746
Kerb weight without driver → page 388	kg	1671
Gross vehicle weight rating	kg	2280
Gross front axle weight rating	kg	1190



Gross rear axle weight rating	kg	1140
-------------------------------	----	------

#### Maximum trailer weights

Maximum trailer weight braked, gradients up to 12 %	kg	2200
Maximum trailer weight braked, gradients up to 8 %	kg	2200
Maximum trailer weight unbraked	kg	750
Maximum permitted gross combination weight	kg	4480
Maximum permissible drawbar load	kg	200

Load capacity for rear carrier systems → page 280, *Fitting a rear carrier system or bicycle carrier on the towbar*

## 2.0 l, 4-cylinder TSI®, 235 kW, petrol engine

#### Engine overview

Power output	kW	235 at 5350 – 6500 rpm
Engine code		DNFG
Maximum torque	Nm	420 at 2100 – 5350 rpm
Gearbox		DSG®7
Maximum speed	km/h	250

#### Weights and axle loads

Kerb weight with driver → page 388	kg	1746
Kerb weight without driver → page 388	kg	1671
Gross vehicle weight rating	kg	2220 – 2280
Gross front axle weight rating	kg	1190
Gross rear axle weight rating	kg	1140

#### Maximum trailer weights

Maximum trailer weight braked, gradients up to 12 %	kg	2200
Maximum trailer weight braked, gradients up to 8 %	kg	2200
Maximum trailer weight unbraked	kg	750
Maximum permitted gross combination weight	kg	4420 – 4480
Maximum permissible drawbar load	kg	100

Load capacity for rear carrier systems → page 280, *Fitting a rear carrier system or bicycle carrier on the towbar*

## Diesel engines

### 2.0 l, 4-cylinder, TDi®, 90 kW, diesel engine

#### Engine overview

Power output	kW	90 at 3600 – 4100 rpm
--------------	----	-----------------------

Engine code		DTRC
Maximum torque	Nm	320 at 1750 – 3000 rpm
Gearbox		DSG® 6
Maximum speed	km/h	191

#### Weights and axle loads

Kerb weight with driver → page 388	kg	1590
Kerb weight without driver → page 388	kg	1515
Gross vehicle weight rating	kg	2040 – 2170
Gross front axle weight rating	kg	1120
Gross rear axle weight rating	kg	1100

#### Maximum trailer weights

Maximum trailer weight braked, gradients up to 12 %	kg	1800
Maximum trailer weight braked, gradients up to 8 %	kg	2000
Maximum trailer weight unbraked	kg	750
Maximum permitted gross combination weight	kg	3840 – 3970
Maximum permissible drawbar load	kg	100
Load capacity for rear carrier systems → page 280, <i>Fitting a rear carrier system or bicycle carrier on the tow-bar</i>		

## 2.0 l, 4-cylinder, TDI®, 110 kW, diesel engine

#### Engine overview

Power output	kW	110 at 3500 – 4000 rpm
Engine code		DBGC
Maximum torque	Nm	340 at 1750 – 3000 rpm
Gearbox		DSG® 7
Maximum speed	km/h	– a)

a) Figures were not available at time of publication.

#### Weights and axle loads

Kerb weight with driver → page 388	kg	1699
Kerb weight without driver → page 388	kg	1624
Gross vehicle weight rating	kg	2210 – 2270
Gross front axle weight rating	kg	1180
Gross rear axle weight rating	kg	1140

#### Maximum trailer weights

Maximum trailer weight braked, gradients up to 12 %	kg	2200
Maximum trailer weight braked, gradients up to 8 %	kg	2200
Maximum trailer weight unbraked	kg	750
Maximum permitted gross combination weight	kg	4410 – 4470

Maximum permissible drawbar load	kg	100
Load capacity for rear carrier systems → page 280, <i>Fitting a rear carrier system or bicycle carrier on the tow-bar</i>		

## 2.0 l, 4-cylinder, TDI®, 110 kW, diesel engine

### Engine overview

Power output	kW	110 at 3000 – 4200 rpm	
Engine code		DTSB	
Maximum torque	Nm	360 at 1600 – 2750 rpm	
Gearbox		DSG®7	DSG®7 4MOTION
Maximum speed	km/h	198	198

### Weights and axle loads

Gearbox		DSG®7	DSG®7 4MOTION
Kerb weight with driver → page 388	kg	1631	1716
Kerb weight without driver → page 388	kg	1556	1641
Gross vehicle weight rating	kg	2090 – 2220	2220 – 2300
Gross front axle weight rating	kg	1170	1190
Gross rear axle weight rating	kg	1100	1160

### Maximum trailer weights

Gearbox		DSG®7	DSG®7 4MOTION
Maximum trailer weight braked, gradients up to 12 %	kg	2000	2200 – 2300
Maximum trailer weight braked, gradients up to 8 %	kg	2000 – 2200	2200 – 2300
Maximum trailer weight unbraked	kg	750	750
Maximum permitted gross combination weight	kg	4090 – 4220	4420 – 4600
Maximum permissible drawbar load	kg	100	100

Load capacity for rear carrier systems → page 280, *Fitting a rear carrier system or bicycle carrier on the tow-bar*

## 2.0 l, 4-cylinder, TDI®, 110 kW, diesel engine

### Engine overview

Power output	kW	110 at 3500 – 4000 rpm	
Engine code		DFGA	
Maximum torque	Nm	340 at 1750 – 3000 rpm	
Gearbox		DSG®7	
Maximum speed	km/h	202	

### Weights and axle loads

Kerb weight with driver → page 388	kg	1767	
Kerb weight without driver → page 388	kg	1692	

Gross vehicle weight rating	kg	2280
Gross front axle weight rating	kg	1180
Gross rear axle weight rating	kg	1150

#### Maximum trailer weights

Maximum trailer weight braked, gradients up to 12 %	kg	2500
Maximum trailer weight braked, gradients up to 8 %	kg	2500
Maximum trailer weight unbraked	kg	750
Maximum permitted gross combination weight	kg	4780
Maximum permissible drawbar load	kg	100

Load capacity for rear carrier systems → page 280, *Fitting a rear carrier system or bicycle carrier on the tow-bar*

## 2.0 l, 4-cylinder, TDI<sup>®</sup>, 110 kW, diesel engine

#### Engine overview

Power output	kW	110 at 3250 – 4200 rpm
Engine code		DTSA
Maximum torque	Nm	340 at 1600 – 3000 rpm
Gearbox		DSG6
Maximum speed	km/h	201

#### Weights and axle loads

Kerb weight with driver → page 388	kg	1609
Kerb weight without driver → page 388	kg	1534
Gross vehicle weight rating	kg	2060 – 2190
Gross front axle weight rating	kg	1140
Gross rear axle weight rating	kg	1100

#### Maximum trailer weights

Maximum trailer weight braked, gradients up to 12 %	kg	2000
Maximum trailer weight braked, gradients up to 8 %	kg	2000 – 2100
Maximum trailer weight unbraked	kg	750
Maximum permitted gross combination weight	kg	4060 – 4190
Maximum permissible drawbar load	kg	100

Load capacity for rear carrier systems → page 280, *Fitting a rear carrier system or bicycle carrier on the tow-bar*

## 2.0 l, 4-cylinder, TDI<sup>®</sup>, 130 kW, diesel engine

#### Engine overview

Power output	kW	130 at 3500 – 4000 rpm
Engine code		CRGB

Maximum torque	Nm	380 at 1750 – 3000 rpm
Gearbox		DSG <sup>7</sup>
Maximum speed	km/h	– a)

a) Figures were not available at time of publication.

#### Weights and axle loads

Kerb weight with driver → page 388	kg	1727
Kerb weight without driver → page 388	kg	1652
Gross vehicle weight rating	kg	2210 – 2270
Gross front axle weight rating	kg	1180
Gross rear axle weight rating	kg	1140

#### Maximum trailer weights

Maximum trailer weight braked, gradients up to 12 %	kg	2200
Maximum trailer weight braked, gradients up to 8 %	kg	2200
Maximum trailer weight unbraked	kg	750
Maximum permitted gross combination weight	kg	4410 – 4470
Maximum permissible drawbar load	kg	100
Load capacity for rear carrier systems → page 280, <i>Fitting a rear carrier system or bicycle carrier on the towbar</i>		

## 2.0 l, 4-cylinder, TDI<sup>®</sup>, 147 kW, diesel engine

#### Engine overview

Power output	kW	147 at 3600 – 4100 rpm
Engine code		DTUA
Maximum torque	Nm	400 at 1750 – 3500 rpm
Gearbox		DSG <sup>7</sup>
Maximum speed	km/h	216

#### Weights and axle loads

Kerb weight with driver → page 388	kg	1705
Kerb weight without driver → page 388	kg	1630
Gross vehicle weight rating	kg	2250 – 2300
Gross front axle weight rating	kg	1180
Gross rear axle weight rating	kg	1170

#### Maximum trailer weights

Maximum trailer weight braked, gradients up to 12 %	kg	2200 – 2300
Maximum trailer weight braked, gradients up to 8 %	kg	2200 – 2300
Maximum trailer weight unbraked	kg	750
Maximum permitted gross combination weight	kg	4410 – 4600
Maximum permissible drawbar load	kg	100

Load capacity for rear carrier systems → page 280, *Fitting a rear carrier system or bicycle carrier on the tow-bar*



## Abbreviations used

Abbreviation	Definition
A2DP	Advanced Audio Distribution Profile: manufacturer-independent technology for audio signal transmission via Bluetooth.
AAC	Advanced Audio Coding: format for compressing audio files.
ABS	anti-lock brake system
ACC	Adaptive Cruise Control: adaptive cruise control.
ACT	Active Cylinder Management.
AF	Automatic station tracking
ALAC	Apple Lossless Audio Codec: format for compressing audio files.
AM	(amplitude modulation): Medium wave.
APE	Monkey's Audio: Format for compressing audio files.
AVRCP	Audio Video Remote Control Profile: manufacturer-independent technology for remote control of audio sources via Bluetooth.
BAS	Brake assist system.
CCS	Cruise control system.
DAB	Digital Audio Broadcasting.
DAB+	Digital Audio Broadcasting Plus: enhancement of DAB with optimised digital audio compression.
DCC	adaptive chassis control.
DSG	Doppelkupplungsgetriebe DSG.
EC	Engine code.
ECE	Economic Commission for Europe: Economic Commission for Europe.
EDGE	Enhanced Data Rates for GSM Evolution: technology for enhancing conventional GSM and GPRS mobile networks.
EDL	electronic differential lock
EON	Enhanced Other Network: Enhanced Other Network.
ESC	Electronic Stability Control
eSIM	embedded Subscriber Identity Module: embedded, non-exchangeable SIM card.
FLAC	Free Lossless Audio Codec: format for compressing audio files.
FM	(frequency modulation): very high frequency, VHF.
GPRS	General Packet Radio Service: packet-oriented service for transmitting data in GSM networks.
GPS	Global Positioning System: global navigation satellite system for position determination.
HFP	Hands-free Profile: wireless telephony.
HUD	Head-up display.
ISO	International Organization for Standardization.
LED	Light Emitting Diode: light-emitting diode.
LTE	Long Term Evolution.
MAP	Message Access Profile: protocol for transmission of text messages and e-mails.
MP2	Format for compressing audio files.
MP3	Format for compressing audio files.
MP4	Format for compressing audio files.
MPEG	Moving Picture Experts Group.
NFC	Near Field Communication: standard for data transmission in the near range using radio technology.
OBD	On-Board Diagnostic System.
OPUS	Format for compressing audio files.

Abbreviation	Definition
PBAP	Phone Book Access Profile: manufacturer-independent technology for transmission of mobile telephone phone book data.
PIN	Personal Identification Number.
QR code	Quick Response Code: binary representation of coded data.
RDS	Radio Data System: Radio data system for additional services.
RoHS	Restriction of Certain Hazardous Substances: Directive on the restriction of hazardous substances in electrical and electronic equipment.
SD	Secure Digital (memory card); digital memory card
SIM	Subscriber Identity Module
SMS	Short Message Service: text messaging service.
S-PIN	Security-relevant personal identification number.
SPP	Serial Port Profile: serial data transmission via Bluetooth.
TCS	Traction control system
TIN	Tire Identification Number: tyre identification number.
TP	Traffic Programme in radio mode.
TPM	Tyre Pressure Monitoring System
TWI	Tread Wear Indicator: tread wear indicator.
UMTS	Universal Mobile Telecommunications System: mobile communications standard that enables Internet access and other multimedia functions.
UPnP	Universal Plug and Play: Standard zur herstellerübergreifenden Ansteuerung von Geräten.
USB	Universal Serial Bus: serial bus system for connecting external devices.
VIN	Vehicle identification number.
WAV	Waveform: Audio file format.
WLAN	Wireless Local Area Network: Wireless Local Area Network.
WMA	Format for compressing audio files.
WPA2	Wi-Fi Protected Access 2: Verschlüsselungsmethode für ein drahtloses Netzwerk.
WPS	Wi-Fi Protected Setup: Standard for simple setup of a wireless local area network with encryption.
XDS	Extension of the electronic differential lock.





# Index

## Other Characters

Директива  
TR-355

## A

### Abroad

- Extended trips with your vehicle 137
- Selling the vehicle 137

**ABS** 208

**ACC**  
see Adaptive Cruise Control (ACC) 171

**Accessing service schedules** 33

**Accessories** 361

### Acoustic warnings

- Seat belt not fastened 45
- Warning and indicator lamps 17

### Activating functions

- see We Upgrade 223
- Troubleshooting 224

### Adaptive chassis control (DCC)

- see Driving profile selection 156
- Troubleshooting 158

### Adaptive Cruise Control

see Adaptive Cruise Control (ACC) 171

### Adaptive Cruise Control (ACC)

- Driving situations 172
- Overtaking assistance 172
- Overtaking prevention 173
- Predictive cruise control 177
- Radar sensor 172, 173
- Setting 175
- Switching on and off 174
- System limits 173
- Troubleshooting 176

### AdBlue

- Refilling 288
- see Emission control 286
- Troubleshooting 289

### Additional instruments

Offroad display 159

### Adjusting

- Correct sitting position 43
- Electrically adjustable front seat 92
- Folding the front passenger seat backrest forwards 93
- Head restraints 97
- Headlight range 109
- Massage function 102
- Memory function 99, 100
- Steering wheel 89

**Adjusting playback volume** 244

**Advanced main-beam control (Dynamic Light Assist)** 105

- Switching on and off 105
- Things to note 107

**Aerials** 370

### After offroad driving

see offroad driving situations 167

### Air Care

see Air conditioning system 120

### Air conditioning menu

### Air conditioning system

- Adjusting the temperature 121
- Air Care 120
- Air distribution 122
- Air recirculation mode 123
- Automatic mode 120
- Automatic supplementary heater 125
- Auxiliary heater and auxiliary ventilation 126
- Blower 122
- Climatronic 119
- Cooling mode 121
- Defrosting windows 122
- for rear seats 121
- manual air conditioning system 121
- Maximum cooling output 121
- Menu in the Infotainment system 120
- Rear window heating 125
- REAR-LOCK function 121
- Seat heating 123
- Service fluids 369
- Steering wheel heating 124
- Switching off 120, 121
- SYNC function 121
- Temperature control 121
- Troubleshooting 129
- Windscreen heating 125

### Air pressure

see Tyre pressure 334

### Air recirculation mode

Air Care 120  
see Air conditioning system 123

### Airbag system

- Automatic battery switch-off 322
- Curtain airbags 57
- Description 53
- Faults 363
- Front airbags 54
- Function 53
- Indicator lamp 52
- Repairs 363
- Side airbags 56
- Switching off the front passenger front airbag 55
- Using child seats 55

### Alarm system

78

### All-wheel drive

- Troubleshooting 158
- Winter tyres 340

**All-year tyres** 339

<b>Analogue fuel gauge</b>	28	Lane change system (Side Assist)	188
<b>Analogue instrument cluster</b>		Lane keeping system (Lane Assist)	182
Display	26	Park Assist	201
Engine code	27	Park Distance Control	197
Instruments	26	Predictive cruise control	177
Mileage displays	27	Proactive occupant protection system	49
Operation using the multifunction steering wheel	26	Rear Traffic Alert	207
Operation with the wiper lever	26	Rear view camera system	199
see Service menu	32	Speed limiter	170
Service interval display	33	Traction control system (TCS)	207
Time	34	Trailer Assist	205
<b>Android Auto</b>		Trailer manoeuvring system (Trailer Assist)	205
Using	229	Travel Assist	184
<b>Anti-freeze</b>	319	Tyre monitoring system	326
<b>Anti-lock brake system (ABS)</b>	208	Tyre Pressure Loss Indicator	328
<b>Anti-theft alarm</b>	78	Tyre Pressure Monitoring System	329
Anti-tow alarm	79	<b>Asymmetrical tyres</b>	339
Description	78	<b>AUTO function</b>	
Interior monitoring system	79	see air conditioning system	120
Trailer	274	<b>Auto Hold function</b>	192
<b>Anti-theft wheel bolts</b>	343, 344	<b>Automatic braking intervention</b>	196
<b>Anti-tow alarm</b>	79	<b>Automatic gearbox</b>	147
<b>App-Connect</b>	227	Coasting	150
Apps	228	overheated	151
Settings	228	<b>Automatic lighting control</b>	109
<b>Apple CarPlay</b>	228	<b>Automatic mode</b>	
<b>Applications (apps)</b>	228	see air conditioning system	120
<b>Area monitoring system (Front Assist)</b>		<b>Automatic Post-Collision Braking System</b>	208
see Front Assist	179	<b>Automatic switch-off for electrical consumers</b>	324
<b>Area View</b>	204	<b>Auxiliary equipment or body parts</b>	362
Areas of the screen	204	<b>Auxiliary heater and auxiliary ventilation</b>	
Operating Area View	204	Operating mode	127
Prerequisites	194	Programming	127
Screen display	204	Remote control	127
Screen displays	195	Remote control range	128
see Area View	204	Running time	127
Switching on and off	204	Supplementary heater function	125
<b>Areas where special regulations apply</b>	259	Switching on	126, 127
<b>Armrest</b>	98	<b>Average consumption</b>	21
<b>Ashtray</b>	211		
<b>Assist systems</b>		<b>B</b>	
4MOTION Active Control	155	<b>Background lighting</b>	110
Adaptive Cruise Control (ACC)	171	<b>Bag hook</b>	271
Area monitoring system (Front Assist)	179	<b>Ball coupling</b>	
Area View	204	Swivelling out	277
Auto Hold function	192	<b>BAS</b>	208
Automatic Post-Collision Braking System	208	<b>Bass speaker</b>	
Cruise control system	168	see Subwoofer	345
Downhill speed control	153	<b>Belt retractor</b>	47
Driver Alert System	38	<b>Belt status display</b>	
Driving profile selection	155	see Seat belts	45
Dynamic Road Sign Display	39	<b>Belt tension limiter</b>	47
Electronic Stability Control (ESC)	207	<b>Belt tensioner</b>	47
Emergency Assist	187	Service and disposal	48
Hill Descent Control	153	<b>Bench seat</b>	95
Hill Start Assist	152	<b>Bicycle carrier</b>	280
		<b>Bluetooth</b>	232

Profile	232	When not to use	349
see Digital instrument cluster Pro version	25	<b>Buckle-up request</b>	
<b>Bonnet</b>		see Seat belts	45
Closing	312	<b>Bulb failure</b>	
Display	313	see Changing bulbs	294
Opening	312	<b>Button cell</b>	
Warning lamp	313	Replacing in the vehicle key	71
<b>Boot</b>		see Remote control	128
see Luggage compartment	266	<b>C</b>	
<b>Boot lid</b>	80	<b>Camera lenses</b>	
Closing	83	Cleaning and care	358
Closing automatically	83	<b>Cameras</b>	
Driving with an open boot lid	136	Add-on parts	363
Electrically closing	81	Damage	363
Electrically opening	81	Repairs	363
Opening	82	<b>Capacities</b>	
Opening automatically	82	Tank capacity	392
Unlocking manually	84	<b>Car wash</b>	
<b>Brake</b>		Matt paint	356
faulty	138	Vehicle care	355
<b>Brake Assist system</b>	208	<b>Car washes</b>	356
<b>Brake fluid</b>	321	<b>Care</b>	
Specification	321	see Vehicle care	355
<b>Brake servo</b>	208	<b>Catalytic converter</b>	
<b>Brake support systems</b>		see Emission control	290
Switching ESC on and off	209	<b>CCS</b>	
Switching TCS on and off	209	see Cruise control system	168
Troubleshooting	209	<b>Central locking</b>	
<b>Brake system</b>		Anti-theft alarm	78
Malfunction	138	Central locking button	74, 75
Troubleshooting	138	Description	75
<b>Brakes</b>		Indicator lamp	78
Brake fluid	321	Locking and unlocking from the inside	75
Brake fluid level	321	Single door unlocking	75
Brake pads	135, 138	<b>Central locking system</b>	
Brake servo	208	SAFELOCK	77
Braking performance reduced	138	<b>Centre armrest</b>	98
Changing the brake fluid	321	<b>Changing a wheel</b>	343
Electronic parking brake	191	Lifting the vehicle	347
Emergency braking function	192	Preparations	343
Parking brake	191	Removing the subwoofer	345
Running in brake pads	135	Wheel bolts	344
<b>Braking</b>		<b>Changing bulbs</b>	294
Unusual noises	138	Checklist	295
<b>Braking intervention</b>		In the front bumper	296
Automatic	196	Preparations	295
Damage minimisation	196	Turn signal in the headlight	295
<b>Break recommendation</b>		<b>Changing gear</b>	146
see Driver Alert System	38	DSG dual clutch gearbox	147
<b>Breakdown</b>		Gear-change indicator	131
Making your vehicle safe	65	Manual gearbox	146
<b>Breakdown Call</b>	67	Selecting a gear	147
<b>Breakdown set</b>	349	Selecting a gear (manual gearbox)	146
Check after driving for 10 minutes	351	With Tiptronic	149
Contents	350	<b>Changing gear correctly</b>	
Inflating the tyre	351	see Offroad driving situations	163
Preparations	350	<b>Changing lights</b>	
Sealing the tyre	351		

see Changing bulbs	294	Bluetooth	232
<b>Chassis</b>		Cable	231
see Driving profile selection	156	USB	231
<b>Chassis number</b>		Wireless	231, 232
see Vehicle identification number	388	<b>Connectivity components</b>	214
<b>Checking the oil level</b>	316	<b>Consumables</b>	313
<b>Checklist</b>		<b>Continuous parking light</b>	108
After driving offroad	167	<b>Control elements</b>	237, 238, 240
Before driving offroad	162	<b>Control units</b>	
Before driving offroad for the first time	160	Reprogramming	367
Before working in the engine compartment	311	System update	214
Breakdown	65	<b>Controls</b>	
Breakdown set	350	Cleaning and care	359
Changing bulbs	295	Electrically adjustable front seat	92
Emergency	65	Mechanically adjustable front seat	91
Lifting the vehicle with the jack	347	<b>Convenience closing</b>	
Preparation for changing a wheel	343	Glass roof	88
<b>Cheque cards, data loss</b>	260	Windows	85
<b>Child seat</b>	58	<b>Convenience functions</b>	
Airbag sticker	60	Reprogramming	367
Approval categories	60	<b>Convenience opening</b>	
Securing systems	62	Glass roof	88
Securing with a seat belt	65	Windows	85
Securing with ISOFIX or i-Size	62	<b>Convenience turn signal</b>	102
Securing with the top tether	64	<b>Conversions</b>	362, 369
Standards	59	<b>Coolant</b>	318, 319
Switching off the front passenger front airbag	55	Checking the coolant level	319
Weight classes	59	Filler opening	319
<b>Childproof lock</b>	77	Refilling	319
Electrical	77	Specification	319
<b>Cigarette lighter</b>	211	Temperature display	29, 30
<b>Cleaning</b>		Troubleshooting	30
see Vehicle care	355	<b>Cooling</b>	
<b>Climatronic</b>		see air conditioning system	121
see Air conditioning system	119	<b>Copyright law</b>	244
<b>Closing</b>		<b>Cornering light</b>	
Doors	74	Things to note	107
Glass roof	87	<b>Counter steering assistance</b>	155
Sun blind in the glass roof	117	<b>Cruise control system</b>	168
Windows	85	Displays	168
<b>Coasting</b>	150	Operating	168
<b>Cockpit</b>	12	<b>Cruise control system (CCS)</b>	
<b>Code of conduct for offroad driving</b>	162	Troubleshooting	169
<b>Collapsible spare wheel</b>		<b>Curtain airbags</b>	
Snow chains	341	see Airbag system	57
<b>Combustion engine</b>		<b>Customer information</b>	365
Running in	137	<b>Cybersecurity</b>	214
<b>Comfort drive (Travel Assist)</b>		<b>D</b>	
see Travel Assist	184	<b>Dash panel</b>	12
<b>Comfort tyre pressure</b>	335	Airbag system	50
<b>Coming Home function</b>	108	<b>Data connection</b>	
<b>Commercial vehicle registration</b>	372	see Internet	224
<b>Compass</b>		<b>Data Link Connector (DLC)</b>	362
see Digital instrument cluster Pro version	25	<b>Data memory</b>	
<b>Component protection</b>	370	Convenience functions	367
<b>Connection</b>		Data services	366
		<b>Data storage</b>	

Control units	366	Radiator fan run-on	25
Disclosure of data	366	Selecting information profiles	23
Event data recorder	368	Selector lever position	24
Event memory	362, 366	Service interval display	33
Infotainment system	367	Speed warning	25
Integration of mobile telephones	367	Telephone information	25
On-Board Diagnostic System (OBD)	366	Time	34
Online services	368	<b>Dimensions</b>	6, 391
Operating data in the vehicle	366	Trailer towing	279
Personal reference	366	<b>Directions and positions</b>	6
Rights	366	<b>Directive</b>	
<b>Data transfer</b>	214	2014/53/EU	373
Blocking	221	<b>Display and operating unit</b>	
Unblocking	221	6.5"	240
<b>Daytime running lights</b>	103	8"	238
<b>DCC</b>		9.2"	237
see Driving profile selection	156	<b>Displays</b>	
<b>De-icing</b>		Area View	195
see Air conditioning system	125	Bonnet	313
<b>De-icing door lock cylinders</b>	359	Cruise control system	168
<b>Declaration of conformity</b>	371, 373	Lane keeping system (Lane Assist)	183
Radio systems	378	Park Assist	195
<b>Decorative films</b>		Proactive occupant protection system	50
Cleaning and care	358	Rear view camera system	195
<b>Defrosting</b>		Speed limiter	170
see Air conditioning system	125	Travel Assist	185
see Defrost function	122	<b>Displays, screens</b>	
<b>Diagnostic connection</b>	362, 366	Cleaning and care	359
<b>Diesel</b>		<b>Disposal</b>	
see Fuel	285	Airbag system	371
<b>Diesel engines</b>		Belt tensioner	48
Technical data	399	Electronic devices	370
<b>Differential lock</b>	208	End-of-life vehicle	371
<b>Digital clock</b>		Used batteries	370
see Analogue instrument cluster	34	<b>Doors</b>	74
see Digital instrument cluster Pro version	34	Indicator lamp	78
<b>Digital Cockpit Pro</b>		Manual opening and closing	76
see Digital instrument cluster Pro version	21	<b>Downhill speed control</b>	153
<b>Digital fuel gauge</b>	28	Functional conditions	153
<b>Digital instrument cluster Pro version</b>		Functional requirements	153
Adjusting views	23	<b>Drawbar load</b>	
Bluetooth	25	Explanation of values	388
Compass	25	Loading a trailer	275
Display	21	Rear carrier system	280
Displays	24	<b>Drawers</b>	211
Eco	25	<b>Driver Alert System</b>	38
Engine code	25	Function limitations	38
Gear-change indicator	25	Operating conditions	38
Information displays	23	Operation	39
Information profiles	23	Switching on and off	39
Instruments	21	<b>Driver door</b>	
Mileage displays	25	Indicator lamp	74
Mobile telephone battery	25	<b>Driving</b>	
Operating the navigation map	23	Economically	132
Operation using the multifunction steering wheel	22	Parking on a downhill gradient	190
Operation with the wiper lever	22	Parking on an uphill gradient	190
Outside temperature display	24	Pulling away on uphill gradients	149
		Stopping on uphill gradients	149

Water on the roads	136	Operation	41
With a trailer	276	Speed warning	41
With DSG dual clutch gearbox	149	Switching on and off	41
With respect for the environment	132	System limits	41
<b>Driving abroad</b>		Towing a trailer	41
Headlights	110		
<b>Driving Data</b>	21	<b>E</b>	
<b>Driving data display</b>	31	<b>Earth connection</b>	303
Selecting displays in the Infotainment system	32	<b>EDL</b>	208
<b>Driving downhill</b>		<b>Electric panoramic sliding/tilting sunroof</b>	
see Offroad driving situations	165	see Glass roof	87
<b>Driving economically</b>	132	<b>Electric windows</b>	85
<b>Driving profile</b>		see Windows	
see Driving profile selection	156	<b>Electrical devices</b>	212
<b>Driving profile selection</b>	155	<b>Electromechanical steering</b>	154
Adaptive chassis control (DCC)	156	<b>Electronic differential lock (EDL)</b>	208
Characteristics	157	<b>Electronic immobiliser</b>	142
Characteristics of the driving profiles	157	<b>Electronic parking brake</b>	191
Proactive occupant protection system	50	<b>Electronic Stability Control (ESC)</b>	207–209
Rear axle differential	156	<b>Email</b>	261
Setting a driving profile	156	<b>Emergency</b>	65
Troubleshooting	158	Breakdown	65
<b>Driving through salt water</b>		Checklist	65
see Offroad driving	163	Fire extinguisher	66
<b>Driving through water</b>	136	First-aid box	66
<b>Driving tips</b>		First-aid pack	66
see Offroad driving situations	162	Hazard warning lights	65
Spare wheel	346	Making you and your vehicle safe	65
Temporary spare wheel	346	Warning triangle	66
<b>Driving uphill</b>		<b>Emergency Assist</b>	187
see Offroad driving situations	165	Function	187
<b>Driving with respect for the environment</b>	132	Switching on and off	187
<b>DSG</b>		<b>Emergency braking</b>	196
DSG dual clutch gearbox	147	<b>Emergency braking function</b>	192
<b>DSG dual clutch gearbox</b>		<b>Emergency Call Service</b>	67
Changing gear	147	<b>Emergency switch-off</b>	143
Changing gear correctly offroad	163	<b>Emission control</b>	286
Description	147	AdBlue	286
Driving	149	Catalytic converter	290
DSG	147	Particulate filter	290
Emergency mode	152	Troubleshooting	290
Function	147	<b>Engine</b>	
Kickdown function	149	Emergency switch-off	143
Malfunction	152	Noises	140
overheated	151	<b>Engine and ignition</b>	138
Pulling away on an uphill gradient	149	Automatic ignition switch-off	139
Stopping on an uphill gradient	149	Ignition lock	138
Troubleshooting	151	Ignition switched on warning	138
<b>Dual clutch gearbox</b>		Immobiliser	142
see DSG dual clutch gearbox	149	Preheating	140
<b>Dual clutch gearbox (DSG)</b>	149	Starting the engine	140
<b>Dynamic cornering light</b>		Starting the engine with Keyless Access	139
Special features	106	Switching off the engine	141
<b>Dynamic Road Sign Display</b>	39	Switching off the ignition with Keyless Access	139
Error message	40	Switching on the ignition with Keyless Access	139
Function	39	Unauthorised vehicle key	142
Function limitations	40		

<b>Engine and transmission guard</b>	363	see Offroad driving situations	163
<b>Engine code</b>		<b>Frequency bands</b>	246
see Service menu	32	<b>Front airbags</b>	
<b>Engine compartment</b>	310	see Airbag system	54
Cleaning and care	358	<b>Front Assist</b>	179
Engine oil	314	Advance warning	180
Plenum chamber	358	Distance warning	180
Preparations	311	Operating	181
Safety notes	310	Pedestrian Monitoring	179
<b>Engine oil</b>	314	Problem solving	181
Changing	315	Radar sensor	179
Checking the engine oil level	316	Speed ranges	179
Consumption	315	Switching off	181
Filler opening	316	System boundaries	180
Oil dipstick	316	Urgent warning	180
Refilling	316	<b>Front passenger exterior mirror lowering function</b>	115
Standards	314	<b>Front passenger front airbag</b>	
<b>Engine speed</b>		see Airbag system	50
see Rev counter	28	Switching off with key-operated switch	55
<b>Error message</b>		<b>Front seats</b>	90
Dynamic Road Sign Display	40	Adjusting electrically	92
<b>ESC</b>	208	Electrical controls	92
<b>Event data recorder</b>	368	Mechanical controls	91
<b>Event memory</b>		Mechanically adjusting	91
Connector	362, 366	<b>Fuel</b>	283
<b>Expert assistance</b>	6	Analogue fuel gauge	28
<b>Explanations</b>	6	Diesel	285
<b>Explosion hazard areas</b>	259	Digital fuel gauge	28
<b>Exterior mirrors</b>	115	Fuel standards	283
Folding in	115	Fuel types	283
Saving settings for reversing	115	Identification	283
Synchronous mirror adjustment	116	Misfuelling prevention device	285
<b>External audio sources</b>		Petrol	284
Adjusting volume	244	Refuelling	285
Bluetooth audio	232	Troubleshooting	290
Wi-Fi audio	233	<b>Fuel consumption</b>	
<b>F</b>		Driving economically	132
<b>Fabrics</b>		<b>Fuel gauge</b>	
Cleaning and care	359	Analogue	28
<b>Fastening rings</b>	270	Digital	28
<b>Fault memory</b>		Troubleshooting	28
see Event memory	362, 366	<b>Function buttons</b>	240
<b>Filling</b>		Area View	195
Safety notes	310	Manoeuvre braking	195
<b>Filling the tank</b>		Park Assist	195
Fuel gauge	28	Park Distance Control	195
<b>Fire extinguisher</b>	67	Rear view camera system	195
<b>First-aid box</b>		<b>Function limitations</b>	
see First-aid kit	66	Driver Alert System	38
<b>First-aid kit</b>	66	Dynamic Road Sign Display	40
Storage location	66	<b>Fuses</b>	297
<b>First-aid pack</b>		Changing	301
see First-aid kit	66	Colour coding of fuses	301
<b>Floor mats</b>	131	In the bonnet space	298, 299
<b>Folding the front passenger seat backrest forwards</b>	93	In the dash panel	299, 300
<b>Fording</b>		Types	301

## G

<b>Gear display</b>	
see Gear-change indicator	131
<b>Gear-change indicator</b>	131
see Digital instrument cluster Pro version	25
<b>Gearbox</b>	
engage reverse gear	146
Troubleshooting	158
<b>Glass roof</b>	6, 87
Closing	87
Convenience closing	88
Convenience opening	88
Malfunction	87
Opening	87
Roll-back function	88
Sun blind in the glass roof	117
<b>Glove box</b>	
Light	110
<b>Gradient angle</b>	
Explanation of values	388
<b>Gross combination weight</b>	
Explanation of values	388

## H

<b>Hand wash</b>	357
<b>Handbrake</b>	
see Parking brake	191
<b>Hazard warning lights</b>	65
<b>Head restraint</b>	96, 97
<b>Head restraints</b>	
Removing and installing	97
<b>Head-up display (HUD)</b>	30
Height adjustment	30
Settings in the Infotainment system	30
Switching on and off	30
<b>Headlight range control</b>	109
<b>Headlights</b>	
Cleaning and care	359
Driving abroad	110
<b>Heated seats</b>	
see Air conditioning system	123
<b>Heating</b>	
see air conditioning system	121
<b>High-pressure cleaner</b>	356
<b>High-visibility waistcoat</b>	66, 67
<b>Hill Descent Control</b>	153
<b>Hill Start Assist</b>	152
Functional conditions	152
Functional requirements	152
<b>Hood</b>	
see Bonnet	312
<b>Hubcaps</b>	341
Centre wheel trim	341
Wheel bolt caps	342
Wheel cover	342

## I

<b>i-Size</b>	62
<b>Ice removal</b>	
see Defrost function	122
<b>Identification number</b>	
see Vehicle identification number	388
<b>Ignition</b>	
see Engine and ignition	138
<b>Ignition lock</b>	138
<b>Illustrations</b>	6
<b>Immediate heating (auxiliary heater)</b>	
see Auxiliary heater and auxiliary ventilation	126
<b>Immobiliser</b>	142
<b>Importer of radio equipment devices</b>	379
<b>Indicator lamps</b>	
Airbag system	52
Overview	17
Tyre monitoring system	330
<b>Information Call</b>	67
<b>Information displays</b>	
see Digital instrument cluster Pro version	23
<b>Infotainment system</b>	234
Adapting menus	242
aerials	370
Before using for the first time	234
Carrying out functions	241
Cleaning	244
Control centre	242
Digital instructions	241
Function buttons	242
Getting started	234
Lap timer	35
Media mode	248
Mobile phone interface	257
Navigation	251
Notes on use	236
Offroad display	159
Operating	241
Overview and controls	240
Performance monitor	36
Personal menus	242
Personalising	242
Radio	245
Radio mode	245
Safety notes	234
Settings	243
Sound settings	243
Start screen	241
Switching on and off	241
System settings	243
Tiles	242
Vehicle settings	37
Voice control	262
<b>Inspection</b>	353
see Service interval display	33
<b>Inspection now!</b>	
see Service interval display	33



<b>Instrument cluster</b>			
Analogue instrument cluster	26	Side Assist Plus	189
Coolant temperature display	29	Switching on and off	188
Fuel gauge	28	System limits	188
see analogue instrument cluster	26	Troubleshooting	189
see Digital instrument cluster Pro version	21	<b>Lane keeping system (Lane Assist)</b>	182
Service	32	Displays	183
Sports displays	35	Switching on and off	183
Symbols	17	System limits	182
Warning and indicator lamps	17	Troubleshooting	184
Warning and information messages	20	<b>Lap timer in the Infotainment system</b>	
<b>Instruments</b>	26	Lap times	35
see Digital instrument cluster Pro version	21	Opening	35
<b>Interior mirror</b>	115	Stopwatch	35
<b>Interior monitoring system</b>	79	<b>Leatherette</b>	
Risk of false alarm	79	Cleaning and care	359
<b>Internet</b>		<b>Leaving Home function</b>	108
Quick connection (WPS)	225	<b>LED lights</b>	294
Setting up a data connection	224	<b>Licences</b>	244
Wi-Fi Client	226	<b>Lifting the vehicle</b>	
Wi-Fi hotspot	225	Checklist	347
<b>Internet radio</b>	248	Jack	347
<b>ISOFIX</b>	62	<b>Light</b>	
see Child seat	58	Acoustic warnings if lights are not switched off	110
<b>J</b>		<b>Light Assist</b>	
<b>Jack</b>	343, 347	see Main-beam control	104
<b>Jump starting</b>		<b>Lights</b>	102, 272
Earth connection	303	Activate automatic switch-off of side lights and parking lights	108
Jump leads	303	Advanced main-beam control (Dynamic Light Assist)	105
Jump-start connection point (earth connection)	303	AUTO	109
Jump-start connection point (positive battery terminal)	303	Automatic lighting control	109
Positive battery terminal	303	Background lighting	110
Procedure	303	Coming Home	108
		Continuous parking light on both sides of the vehicle	108
		Cornering light	109
		Daytime running lights	103
		Dynamic cornering light	106
		Dynamic headlight range control	109
		Headlight range control	109
		Instrument and switch lighting	110
		Interior and reading lights	110
		Leaving Home	108
		Main-beam control	104
		Poor weather light	106
		Rear fog light	107
		Side lights	107
		Switching on and off	103
		Vehicle lighting	102
		<b>Limiter</b>	
		see Speed limiter	170
		<b>Load</b>	
		Rear carrier system	280
		<b>Load compartment net</b>	270
		<b>Load-through hatch</b>	271
		<b>Loading</b>	
<b>Key</b>			
Vehicle key	71		
<b>Key-operated switch</b>			
Switching off front passenger front air-bag	55		
<b>Keyless Access</b>	72		
Emergency switch-off	143		
Press & Drive	139		
Starter button	139		
Steering column lock	154		
<b>Keyless Go</b>			
see Press & Drive	139		
<b>Keyless locking and starting system Keyless Access</b>			
see Keyless Access	72		
<b>Kickdown function</b>	149		
<b>L</b>			
<b>Lane Assist</b>			
see Lane keeping system (Lane Assist)	182		
<b>Lane change system (Side Assist)</b>	188		

Driving with an open boot lid	136	Front passenger door	76
Fastening rings	270	Rear doors	76
General information	266	<b>Marks</b>	244
Load-through hatch	271	<b>Massage function</b>	102
Luggage compartment	266	<b>Matt paint</b>	
Trailer	275	Automatic car wash	356
<b>Location services</b>	222	High-pressure cleaner	356
<b>Lock button</b>	148	Removing stubborn dirt	356
<b>Locking</b>		<b>Maximum trailer weight</b>	
From the inside	75	Explanation of values	388
<b>LongLife mobility guarantee</b>	366	<b>Media</b>	
<b>Luggage compartment</b>	266	Playing	250
Light	272	Using streaming services	250
Luggage compartment cover	267	<b>MEDIA</b>	
Luggage net	270	Bluetooth audio	232
Net partition	268, 269	Wi-Fi audio	233
Variable luggage compartment floor	267	<b>Media connections</b>	231
<b>Luggage compartment cover</b>	267	<b>Media drive</b>	
Installing	267	SD card	241
Removing	267	<b>Media mode</b>	248
Stowing	267	Favourites	250
<b>Luggage compartment equipment</b>	270	Online functions	251
<b>Luggage compartment floor</b>	267	Playing a media source	250
<b>Luggage compartment light</b>	272	Scope of equipment	249
<b>Luggage net</b>	270	Selecting a media source	250
		Streaming services	251
		Symbols	249
		Video mode	251
<b>M</b>		<b>Memory function</b>	99, 100
<b>Magnetic strips, data loss</b>	260	<b>Menu</b>	
<b>Main-beam control</b>	104	Apple CarPlay	228
Switching on and off	104	<b>MFD</b>	
System limits	104, 105	see Multifunction display	31
<b>Malfunction</b>		<b>Microfibre fabrics</b>	
Component protection	370	Cleaning and care	359
DSG dual clutch gearbox	152	<b>Mileage</b>	21
Glass roof	87	<b>Mileage displays</b>	
Park Assist	197, 201	see Analogue instrument cluster	27
Proactive occupant protection system	50	see Digital instrument cluster Pro version	25
Rain and light sensor	113	<b>Mileage recorder</b>	26
Towing bracket	274	<b>MirrorLink</b>	230
Trailer manoeuvring system (Trailer Assist)	205	Connecting	230
Tyre monitoring system	330	<b>Mirrors</b>	114
<b>Malfunctions</b>		Convenience functions	115
Park Distance Control	197	Exterior mirrors	115
<b>Manoeuvre braking</b>	196	Front passenger exterior mirror lowering function	115
<b>Manoeuvring</b>	190	Interior mirror	115
<b>Manoeuvring vehicle and trailer</b>	206	Synchronous mirror adjustment	116
<b>Manual air conditioning system</b>		<b>Misfuelling prevention device</b>	
see air conditioning system	121	see Fuel	285
<b>Manual gearbox</b>	146	<b>Mobile phone interface</b>	257, 258
Clutch defective	147	Basic equipment	259
Clutch is slipping	147	Comfort	259
Clutch overheated	147	Contacts	262
see changing gear	146	Equipment	258
Troubleshooting	147	Explosion hazard areas	259
<b>Manual opening and closing</b>		Favourites	262
Boot lid	84		
Driver door	76		

Pairing	260	Engine	140
Speed dial buttons	262	<b>Notes on driving</b>	131
Switching off	259	<b>Number of seats</b>	43
Symbols	258	<b>O</b>	
Telephone book	262	<b>Odometer</b>	25–27
<b>Mobile telephone</b>		<b>Offroad display</b>	
Switching off	259	Altimeter	159
Use without external aerial	364	Compass	159
<b>Mobile telephone battery</b>		Coolant temperature display	159
see Digital instrument cluster Pro version	25	Oil temperature display	159
<b>Modifications to the vehicle</b>	361, 362	Selecting instruments	159
Plates	369	Steering angle display	159
Stickers	369	<b>Offroad driving</b>	160
<b>Mounting points</b>		After driving through water	164
Trailer towing	279	Driving tips	162
<b>Multifunction display</b>	31	Explanation of technical terms	161
<b>N</b>		<b>Offroad driving situations</b>	
<b>Natural leather</b>		After driving offroad	167
Cleaning and care	359	Before driving offroad	162
<b>Navigation</b>	251, 253, 255	Before driving offroad for the first time	160
Additional window	256	Changing gear correctly	163
Controlling the navigation map	252	Driving downhill	165
Destination	255	Driving through ditches	167
Destination input	255	Driving through salt water	163
Edit route	256	Driving through water	163
Entering an address for route guidance	255	Driving uphill	165
Equipment level	253	Getting out of the vehicle on a steep slope	166
Favourite destinations	255	If your vehicle gets stuck	165
Last destinations	255	Rocking free	165
Learn usage patterns	257	Rough terrain	163
Map	256	Safety notes	160
Navigation announcements	252	Steep terrain	165
Offroad mode	256	Through sand and mud	164
Operating the map	256	Traversing a slope	166
Recommended destinations	255	<b>Oil</b>	
Restrictions	252	see Engine oil	314
Route guidance	255	<b>Oil change service</b>	353
Route plan	256	<b>Oil dipstick</b>	316
Saved data	253	<b>Oil service and inspection now!</b>	
Saving a destination	255	see Service interval display	33
Saving destinations	255	<b>Oil service now!</b>	
Selecting a destination	255	see Service interval display	33
Starting route guidance	255	<b>Old tyres</b>	332
Stored destinations	255	<b>On-Board Diagnostic System (OBD)</b>	362, 366
Symbols	253	<b>Online functions</b>	
Traffic announcements	257	Media mode	251
Updating navigation data	254	Radio mode	248
Using contact data	256	<b>Online services</b>	217
Using the map for destination input	256	<b>Online vehicle functions</b>	222
Zooming into the navigation map	252	<b>Opening</b>	
Zooming out of the navigation map	252	Doors	74
<b>Net partition</b>	268, 269	Glass roof	87
<b>New combustion engine</b>	137	Sun blind in the glass roof	117
<b>New tyres</b>	332	Windows	85
<b>Noises</b>		<b>Operating mode</b>	
Brake support systems	210	Auxiliary heater and auxiliary ventilation	127
Electronic parking brake	192		

<b>Other applicable documents</b>	234	<b>Parking systems</b>	
<b>Other instruments</b>		Displays	194
see Performance monitor	36	Function buttons	194
<b>Outside temperature display</b>		General information	193
see Digital instrument cluster Pro version	24	Prerequisites	194
<b>Overview</b>		Safety notes	193
Centre console	14	Settings	194
Driver door	10	Troubleshooting	197
Driver side	12	<b>ParkPilot</b>	
Front passenger side	15	see Park Distance Control	197
Front view	8	<b>Particulate filter</b>	
Instruments	26	Gear-change indicator	132
Rear view	9	see Emission control	290
Roof	16	<b>Parts</b>	361
Vehicle	8	<b>PDC</b>	
Warning and indicator lamps	17	see Park Distance Control	197
<b>Overview of indicator lamps</b>	17	<b>Pedals</b>	43, 131
<b>Overview of warning lamps</b>	17	<b>Pedestrian Monitoring</b>	179
<b>P</b>		<b>Performance figures</b>	
<b>Paddles</b>		Explanation of values	388
Tiptronic	149	<b>Performance monitor</b>	
<b>Paintwork</b>		Accelerometer	36
Cleaning and care	357	Charge pressure display	36
<b>Panoramic sliding roof</b>		Coolant temperature display	36
see Glass roof	87	Oil temperature display	36
<b>Panoramic sliding/tilting sunroof</b>		Power display	36
see Glass roof	87	Selecting instruments	36
<b>Park Assist</b>	201	<b>Personalisation</b>	41
Cancellation	197	Assigning vehicle key	41
Driving into a parking space	202	Settings	41
Driving out of a parking space	203	User management	41
Looking for a parking space	202	<b>Petrol</b>	
Malfunction	201	see Fuel	284
Parks inaccurately	197	<b>Petrol engines</b>	
Premature termination	197	Technical data	392
Prerequisites	194	<b>Plastic parts</b>	
Screen	195	Cleaning and care	359
Steering movements when stationary	197	<b>Plates</b>	369
Wheel change	197	<b>Predictive cruise control</b>	
<b>Park Distance Control</b>		Activating	178
Malfunction	197	System limits	177
Menu	198	Troubleshooting	178
Operating	198	<b>Predictive Cruise Control</b>	
Prerequisites	194	see Predictive cruise control	177
see Park Assist	201	<b>Predictive cruise control system</b>	177
see Trailer manoeuvring system (Trailer Assist)	205	<b>Preheating</b>	140
<b>Parking</b>	190	<b>Preparations</b>	
<b>Parking brake</b>	191	Breakdown set	350
Automatic switch-off	191	Changing a wheel	343
Automatic switch-on	191	Changing bulbs	295
Emergency braking function	192	Checking the coolant level	319
Switching off	191	Checking the engine oil level	316
Switching on	191	Refilling coolant	319
Troubleshooting	192	Refilling engine oil	316
<b>Parking light</b>	108	Vehicle battery (12-volt)	323
Switching on and off	107	Working in the engine compartment	311
		<b>Press &amp; Drive</b>	
		Starter button	139



Cleaning and care	359	Number of seats	43
<b>Running in</b>		Rear bench seat	94
Brake pads	135	Rear seat backrest	95
Combustion engine	137	Removing and installing the head re-	
The first kilometres	137	straints	97
Tyres	333	Seat heating	123
<b>Running in brake pads</b>		Sitting position	43
see Brakes	135	<b>Seats with airbag components</b>	
<b>S</b>		Cleaning and care	359
<b>S-PIN</b>	218	<b>Selecting a gear</b>	147
<b>SAFELOCK</b>		Manual gearbox	146
Safelock	77	<b>Selector lever lock</b>	148
SAFELOCK	77	Manually releasing	151
<b>Safety certificate</b>	390	<b>Selector lever position</b>	
<b>Safety equipment</b>	53	see Digital instrument cluster Pro version	24
<b>Safety notes</b>	234	<b>Selling the vehicle</b>	220
Offroad driving situations	160	In other countries/continents	137
<b>Scrapping</b>	371	<b>Semi-automated vehicle assistance in a medical</b>	
<b>Screen</b>	237, 238, 240	<b>emergency</b>	
Cleaning	244	see Emergency Assist	187
<b>Screen displays</b>		<b>Sensor fields</b>	237, 238
Manoeuvre braking	195	<b>Sensors</b>	
Park Distance Control	195	Add-on parts	363
<b>SD card</b>	241	Cleaning and care	358
<b>Seat belt height adjuster</b>	47	Damage	363
<b>Seat belt routing</b>	46	Repairs	363
<b>Seat belts</b>	44	<b>Service</b>	
Belt retractor	47	Digital service schedule	353
Belt status display	45	Fixed service	353
Belt tension limiter	47	Flexible service	353
Belt tensioner	47	Inspection	353
Buckle-up request	45	Oil change service	353
Cleaning and care	359	Operating conditions	354
Fastening	45	Scope of service	354
Seat belt height adjuster	47	Service events	353
Seat belt routing	46	Service record	353
Twisted seat belt	46	Service repairs	353
Unfastening	45	<b>Service fluids</b>	313
Use	45	<b>Service interval display</b>	354
Warning lamp	45	Accessing a scheduled service	33
<b>Seat covers</b>		Instrument cluster displays	33
Cleaning and care	359	Resetting	33
<b>Seat cushions with seat heating</b>		Service event	33
Cleaning and care	359	<b>Service menu</b>	
<b>Seat functions</b>	98	Displaying the engine code	32
<b>Seat heating</b>		Opening	32
see Air conditioning system	123	Resetting oil service	32
<b>Seats</b>	43, 90	Resetting the service interval display	32
Adjusting the head restraints	97	Resetting the trip recorder	32
Adjusting the steering wheel position	89	Setting the time	32
Correct sitting position	43	<b>Service position</b>	
Electrically adjustable front seat	92	Windscreen wipers	292
Folding the front passenger seat backrest for-		<b>Settings</b>	243
wards	93	Area View	195
Massage function	102	Changing	243
Mechanically adjustable front seat	91	Park Assist	195
Memory function	99, 100	Rear view camera system	195
		Sound	243

System	243	<b>Stopwatch</b>	35
<b>Setup</b>		see Lap timer in the Infotainment system	35
Park Distance Control	195	<b>Stowage areas</b>	210
<b>Side airbags</b>		Drawers	211
see Airbag system	56	Glove box light	110
<b>Side Assist</b>		<b>Stowing loads</b>	266
see Lane change system (Side Assist)	188	<b>Stowing luggage</b>	266
<b>Side lights</b>	107	<b>Streaming services</b>	251
<b>Single door unlocking</b>	75	<b>Stuck vehicle</b>	
<b>Sliding panoramic sunroof</b>		see Offroad driving situations	165
see Glass roof	87	<b>Subwoofer</b>	345
<b>Snow chains</b>	340	<b>Sun blind in the glass roof</b>	
Collapsible spare wheel	341	Opening and closing	117
Temporary spare wheel	341	Roll-back function	117
<b>Sockets</b>	212	<b>Sun visors</b>	117
12-volt	212	<b>Supplementary heating function</b>	125
230-, 115- or 100-volt	212	<b>Supplementary heating system</b>	
Trailer	274	see Auxiliary heater and auxiliary ventilation	126
<b>Sound settings</b>	243	<b>Switch-off for electrical consumers</b>	324
<b>Spanner symbol</b>		<b>Switching main beam on and off</b>	104
see Service interval display	33	<b>Switching off</b>	
<b>Spare wheel</b>	346	Mobile phone interface	259
Driving tips	346	Mobile telephone	259
<b>Spares</b>	361	Telephone	259
<b>Special features</b>		<b>Switching turn signals on and off</b>	102
Infotainment system	370	<b>Symbols</b>	
<b>Speed index</b>	339	see Warning and indicator lamps	17
<b>Speed limiter</b>	170	<b>SYNC function</b>	
Displays	170	see air conditioning system	121
Operating	170	<b>System settings</b>	243
Troubleshooting	171	<b>System update</b>	214
<b>Speed warning</b>	31	Troubleshooting	216
see Digital instrument cluster Pro version	25	<b>Systems</b>	
<b>Speeds</b>	6	Downhill speed control	153
<b>Start/stop mode</b>		Hill Start Assist	152
Troubleshooting	145	Proactive occupant protection system	49
<b>Start/stop system</b>	144		
Indicator lamp	144	<b>T</b>	
When towing a trailer	273	<b>Tachometer</b>	
<b>Starter button</b>	139	see Rev counter	28
<b>Static cornering light</b>		<b>Tail light clusters</b>	
see Cornering light	109	Cleaning and care	359
<b>Steering</b>		<b>Tailgate</b>	
Counter steering assistance	155	see Boot lid	80
Electromechanical	154	<b>Tank capacities</b>	392
Electronic steering column lock	154	<b>TCS</b>	208
faulty	155	<b>Technical data</b>	388
Mechanical steering column lock	154	Capacities	392
Paddles (Tiptronic)	149	Dimensions	391
Power steering	154	Drawbar load	388
Progressive steering	155	Engine oil standards	314
Troubleshooting	155	Factory plate	390
<b>Steering wheel</b>	89	General information	388
Adjusting	89	Gross combination weight	388
Heating	124	Information on the gradient angle	388
<b>Steering wheel heating</b>		Information on weights	388
see Air conditioning system	124	Maximum trailer weight	388
<b>Stickers</b>	369		

Notes	388	Malfunction	274
Performance figures	388	Retrofitting	279
Roof load	282	see Trailer towing	273
Safety certificate	390	Swivelling out	277
Tank capacity	392	<b>TP (Traffic Programme)</b>	
Type plate	390	EON	247
Tyre pressure	334	Function	247
<b>Technical modifications</b>	362	<b>Tracking services</b>	222
Engine and transmission guard	363	<b>Tracking the vehicle</b>	219
Offroad	363	<b>Traction control system (TCS)</b>	207–209
Plates	369	<b>Traction information</b>	257
Stickers	369	<b>Traffic Programme</b>	
<b>Telephone</b>		see TP (Traffic Programme)	247
Connecting	260	<b>Trailer</b>	
Switching off	259	Anti-theft alarm	274
<b>Telephone information</b>		Coupling	274
see Digital instrument cluster Pro version	25	Drawbar load	275
<b>Temperature control</b>	121	Headlight adjustment	276
<b>Temperature display</b>		Hitching	274
Coolant	29, 30	Loading	275
Offroad display	159	Malfunction	274
see Digital instrument cluster Pro version	24	Maximum trailer weight	275
<b>Temporary spare wheel</b>	346	Retrofitting a towing bracket	279
Driving tips	346	see Trailer towing	273
Snow chains	341	Socket	274
<b>Text message</b>	261	Swivelling out the ball coupling	277
<b>Things to note</b>		Things to note	276
Component protection	370	Towing	276
Towing	305, 306	Trailer stabilisation	277
<b>Think Blue.</b>		<b>Trailer Assist</b>	
see Think Blue. Trainer.	134	see Trailer manoeuvring system	206
<b>Think Blue. Trainer.</b>	134	<b>Trailer manoeuvring system (Trailer Assist)</b>	205
<b>Tightening torque</b>		Automatic braking intervention	206
Wheel bolts	344	Malfunction	205
<b>Time</b>		Manoeuvring	206
see Analogue instrument cluster	34	Operating	206
see Digital instrument cluster Pro version	34	Prerequisites	194, 205
<b>Tiptronic</b>	149	Switching on	206
Operating paddles	149	<b>Trailer stabilisation</b>	277
Operating the selector lever	149	<b>Transporting items</b>	266
<b>Tools</b>		Bag hook	271
see Vehicle toolkit	292	Bicycle carrier	280
<b>Top tether</b>		Driving tips	136
see Child seat	58	Driving with a trailer	276
<b>Torque splitter</b>	156	Driving with an open boot lid	136
<b>Total mileage</b>	21	Fastening rings	270
<b>Touchscreen</b>	237, 238, 240	Fitting a roof carrier	281
<b>Tow-bar</b>		Folding the front passenger seat backrest for-wards	93
Fitting a rear carrier system	280	Load-through hatch	271
<b>Tow-starting</b>	302	Loading a trailer	275
<b>Towing</b>	305	Luggage net	270
Front towing eye	307	Roof carrier	281
Rear towing eye	308	Roof carriers	282
Things to note	305, 306	Stowing loads	266
When not to tow	306	Stowing luggage	266
<b>Towing a trailer</b>	273	Towing bracket	277
<b>Towing bracket</b>	277	Trailer towing	273
Fitting a rear carrier system	280		



<b>Travel Assist</b>	184	Front passenger front airbag switched on	53
Displays	185	Fuel gauge	28
Switching on and off	186	Gearbox	158
Troubleshooting	186	Glass roof	88
<b>Travel mode</b>	110	Heating and fresh air system	129
<b>Tread depth</b>	335	Ignition lock	142
<b>Tread wear indicators</b>	336	Immobiliser	144
<b>Trim parts</b>		Indicator lamp in the vehicle key	72
Cleaning and care	358, 359	Irregular engine running	290
<b>Trim strips</b>		Keyless Access	73, 78, 143
Cleaning and care	358, 359	Lane change system	189
<b>Trip recorder</b>		Lane keeping system (Lane Assist)	184
Resetting	25, 27	Lights	106
<b>Troubleshooting</b>		Limited power	142, 143
ABS failure or faulty	209	Manual gearbox	147
Activating functions	224	Misfiring	291
Adaptive chassis control (DCC)	158	One-touch opening and closing	86
Adaptive Cruise Control (ACC)	176	Park Assist	197
AdBlue level low	289, 290	Parking system cameras	197
Air conditioning system	129	Parking system sensors	197
Airbag system	52	Parking systems	197
Airbag system switched off	52	Predictive cruise control	178
Airbag triggering	78	Proactive occupant protection system	50
All-wheel drive	158	Rain and light sensor	107, 113
Automatic gearbox	151	Releasing the selector lever lock manual-	
Automatic locking	78	ly	151
Auxiliary heater and auxiliary ventilation	130	Releasing the selector lever manually	151
Boot lid	85	Removing the vehicle key	143
Brake fluid level too low	321	Roll-back function	86
Brake support systems	209	Selective catalytic reduction system	
Brake system	138	fault	289
Central locking	72	Selector lever lock	151
Checking the engine oil level	317	Sensors	73, 78
Coolant	30	Speed limiter	171
Cooling system	129	Start-up prevented	151
Cruise control system (CCS)	169	Start/stop mode	145
Driving profile selection	158	Starter button	143
DSG dual clutch gearbox	151	Steering	155
DSG emergency mode	152	System update	216
Easy Close	85	Towing bracket	279
Easy Open	85	Trailer turn signals	106
Electronic parking brake	192	Travel Assist	186
Emergency Call Service is faulty	70	Turn signals	73, 78, 85, 106
Emergency Call Service is restricted	70	Tyre monitoring system	330
Emergency start function	143	Tyre Pressure Loss Indicator	330
Emergency switch-off	143	Tyre Pressure Monitoring System	330
Emissions-relevant fault	291	Unit of temperature	130
Engine does not start	151	Vehicle battery (12-volt) indicator lamp	326
Engine management system	142, 143	Vehicle battery (12-volt) warning lamp	326
Engine oil pressure	317	Vehicle key not recognised	143
Engine oil sensor	317	Vehicle lighting	106
Engine oil: engine oil level too low	318	Vision	113
Engine oil: engine oil pressure too low	317	Washer fluid level	113
Engine oil: engine oil sensor fault	318	Water under the vehicle	130
Engine overheating	143	Water vapour under the vehicle	130
Engine speed limitation	143	Window condensation	130
ESC fault	210	Wipers	113
Front passenger front airbag deactivated	53	<b>Type plate</b>	390



<b>Vehicle functions</b>			
Online	222	Proof of identity	219
<b>Vehicle identification number</b>	388	Proof of ownership	219
Position	389	Registration	218
<b>Vehicle key</b>	71	Services	217
Replacing the button cell	71	Volkswagen Ident	219
<b>Vehicle overview</b>		<b>We Upgrade</b>	223
Driver side	12	Activate functions	224
<b>Vehicle overviews</b>		Viewing functions	223
Centre console	14	<b>Weight</b>	
Driver door	10	Explanation of values	388
Front passenger side	15	<b>Wheel bolts</b>	343, 344
Front view	8	Caps	342
Rear view	9	Tightening torque	344
Roof	16	<b>Wheel change</b>	
<b>Vehicle settings</b>	37	Changing a wheel	348
Infotainment system	37	<b>Wheel lock</b>	
<b>Vehicle toolkit</b>	292	see Anti-theft wheel bolts	344
Contents	292	<b>Wheel rims</b>	334
Stowage	292	Bolted rim rings	334
<b>Vehicle tracking</b>	219	Bolted trim elements	334
<b>Vision</b>	111	Identification	334
<b>Voice control</b>	262	<b>Wheels</b>	
Activation word	264	Cleaning and care	359
Android Auto	230	<b>Wheels and tyres</b>	331
Starting	263	All-year tyres	339
Troubleshooting	264	Asymmetrical tyres	339
Voice commands	263	Avoiding damage	332
<b>Voice control (Siri)</b>		Changing a wheel	343
Apple CarPlay	229	Embedded foreign bodies	336
<b>Volkswagen dealership</b>	6	Handling wheels and tyres	332
<b>Volume</b>		Identification	337
Defining external audio sources	244	Low-profile tyres	338
<b>vTAN procedure</b>	219	New tyres	333
		Old tyres	332
		Replacing tyres	333
		Rotating wheels	332
		Running in	333
		Snow chains	340
		Spare wheel	346
		Speed index	339
		Storing tyres	332
		Stowing the removed wheel	346
		Technical data	337
		Temporary spare wheel	346
		Tread depth	335
		Tread wear indicators	336
		Tyre damage	336
		Tyre lettering	337
		Tyre load	339
		Tyre pressure	334
		Tyre type	337
		Tyre wear	336
		Tyres with directional tread pattern	338
		Wheel rims	334
		Winter tyres	339
		<b>Wi-Fi</b>	224
		Client	226
		Connecting an external audio source	233

Hotspot	225
NFC	226
QR-Code	226
Quick connection (WPS)	225
Settings	226
<b>Wi-Fi hotspot</b>	224
<b>Windows</b>	85
Buttons	85
Cleaning and care	359
Closing	85
Convenience closing	85
Convenience opening	85
Defrosting (air conditioning system)	122
Malfunction	85
Opening	85
Roll-back function	86
<b>Windscreen</b>	
Repairing (note)	362
Repairing stone chips (note)	362
Replacing (note)	362
see Head-up-display (HUD)	30
Windscreen heating	125
With communication window	118
With windscreen heating	118
<b>Windshield</b>	
see Windscreen	125, 362
<b>Winter conditions</b>	
Snow chains	340
Vehicle care	356
Winter tyres	339
<b>Winter operation</b>	
Glass roof	87
<b>Winter tyres</b>	339
All-wheel drive	340
Speed limitation	340
<b>Wiper blades</b>	
Changing	293
Cleaning and care	293, 357
<b>Wipers</b>	111
Folding back wiper arm	292
Function	112
Heated washer jets	112
Lifting wiper arm	292
Rain and light sensor	113
Service position	292
Wiper lever	111
<b>Wireless charging function</b>	260
<b>WPS</b>	225
<b>X</b>	
<b>XDS</b>	208